

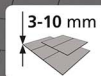

## BL SRF

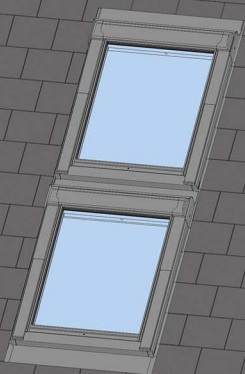

Bi-Lite System - Slate Roof Flashing

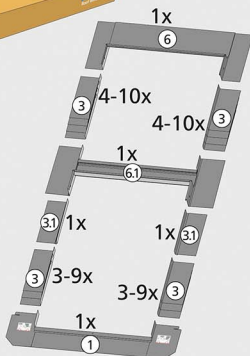
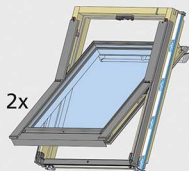

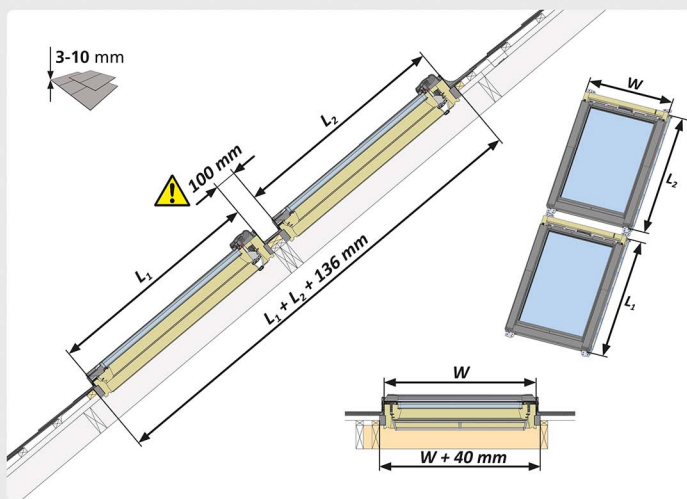

$Q_{ty}$	L
2	$L_1 + L_2 + 136 \text{ mm}$
3	$L_1 + L_2 + L_3 + 232 \text{ mm}$
X	$L_1 + \dots + L_x + (96 * X - 56) \text{ mm}$

+1 **39** ... **51**

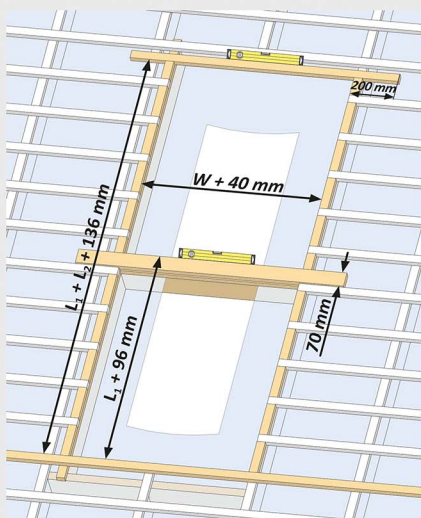

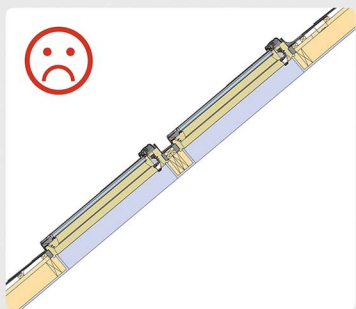

1

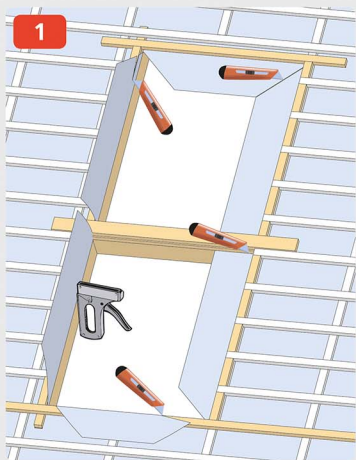

2a

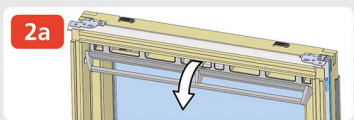

2b

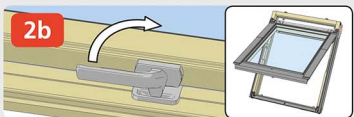

3

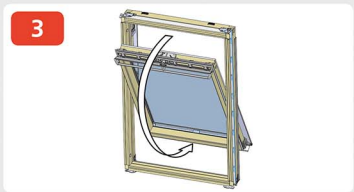

4

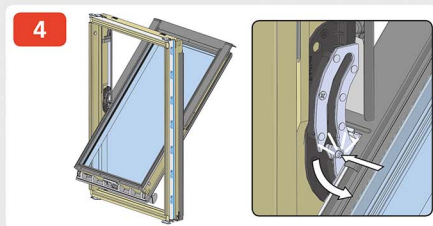

5



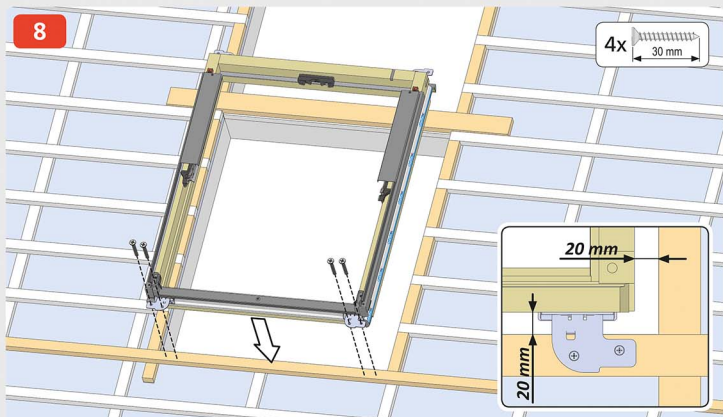
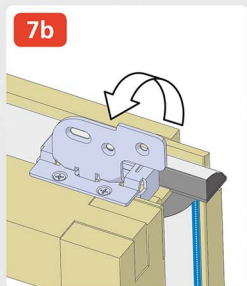
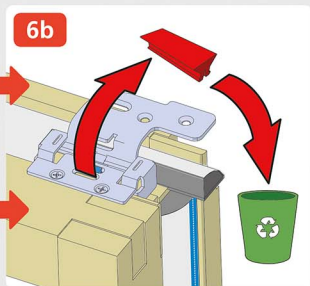
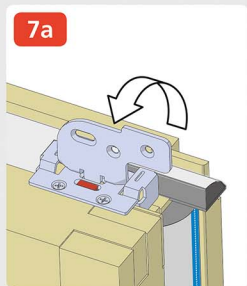
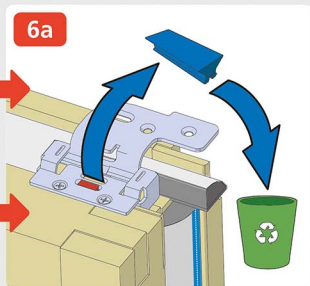
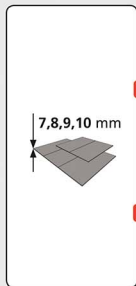

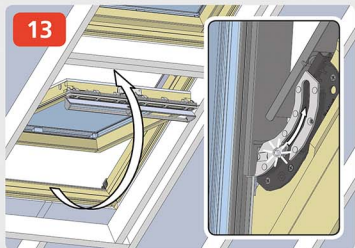
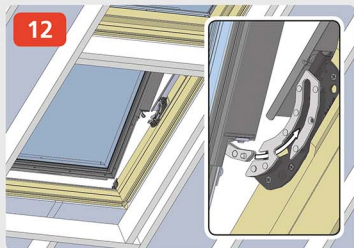
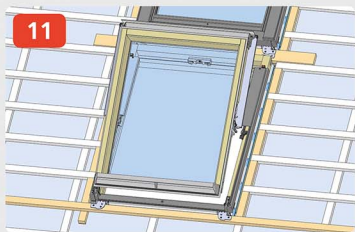
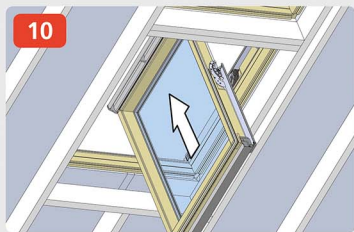
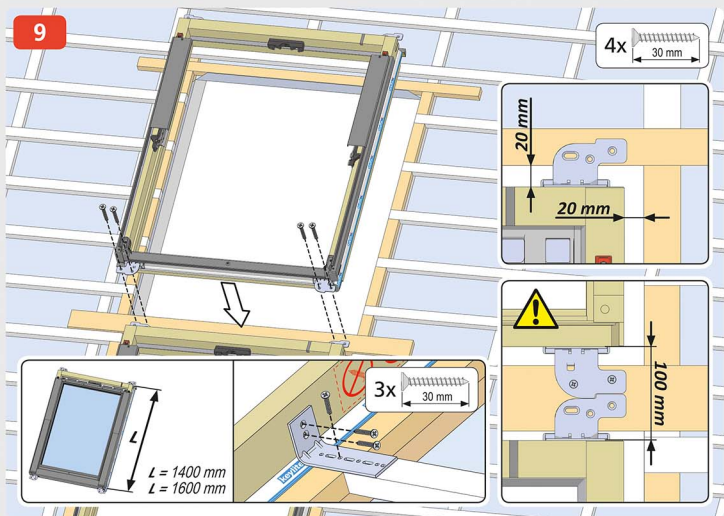

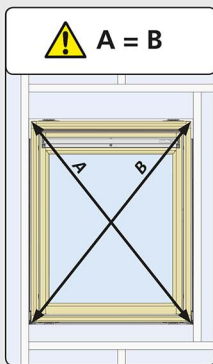
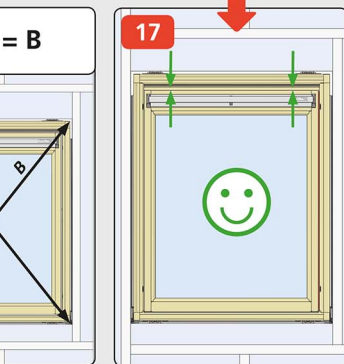
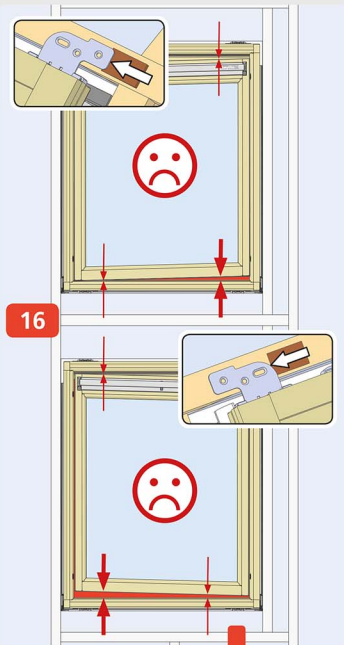
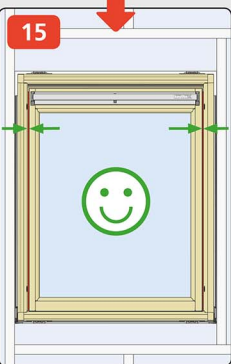
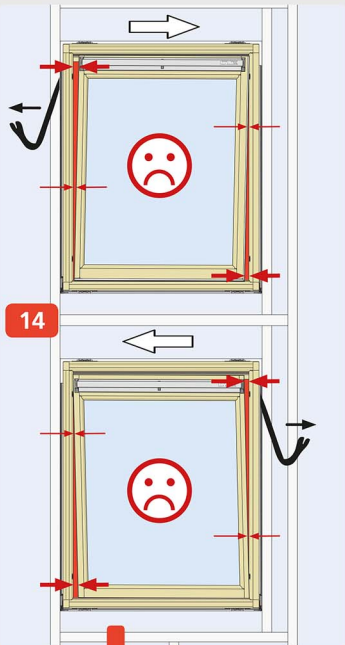

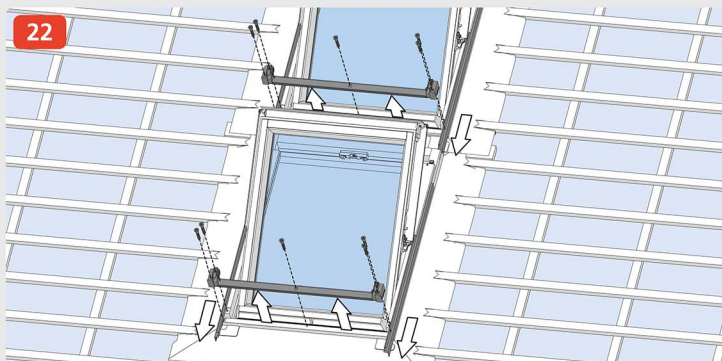
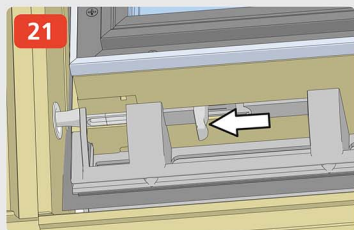
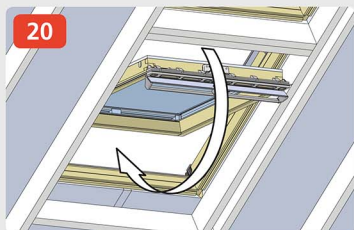
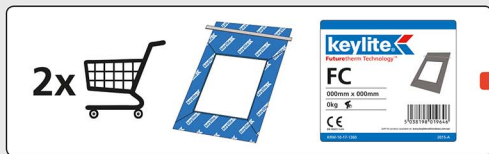
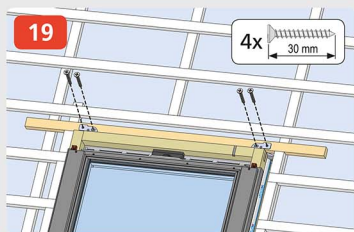
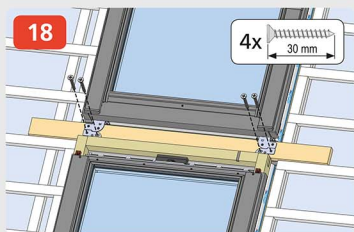

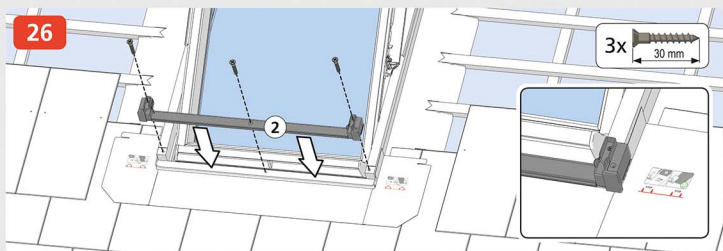
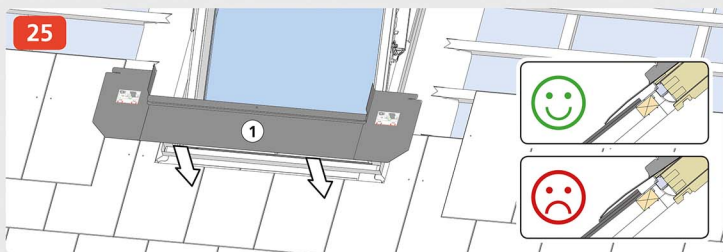
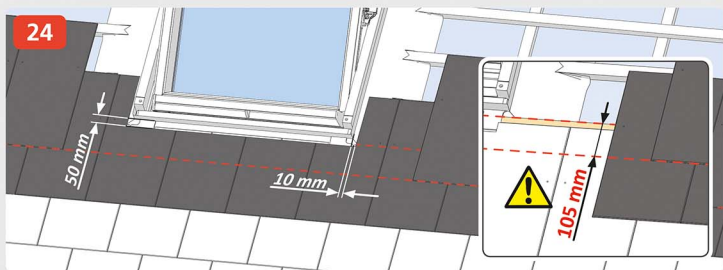
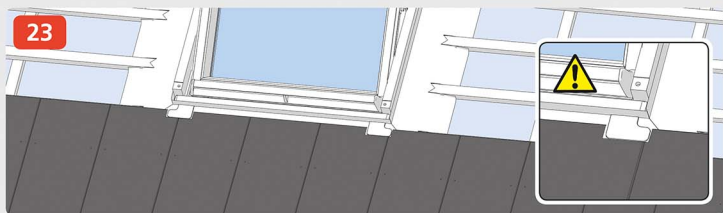



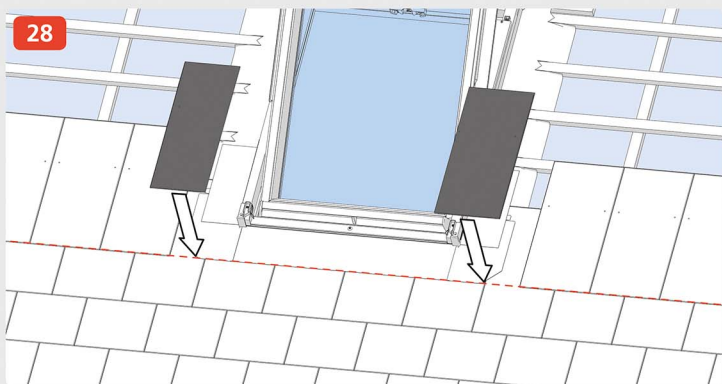
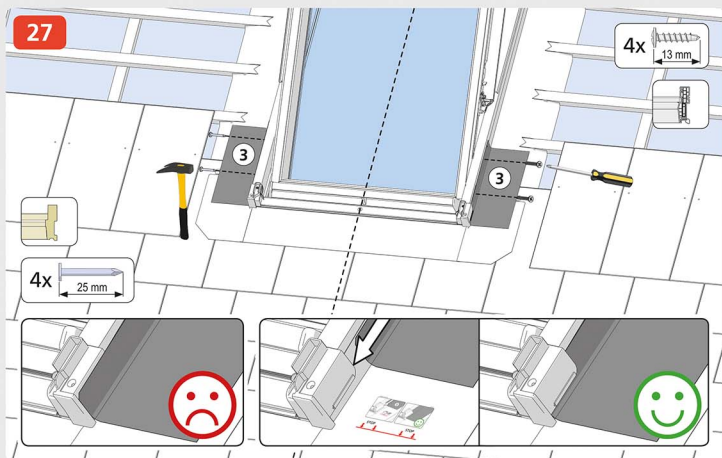
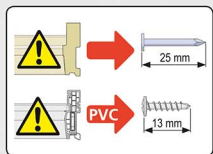

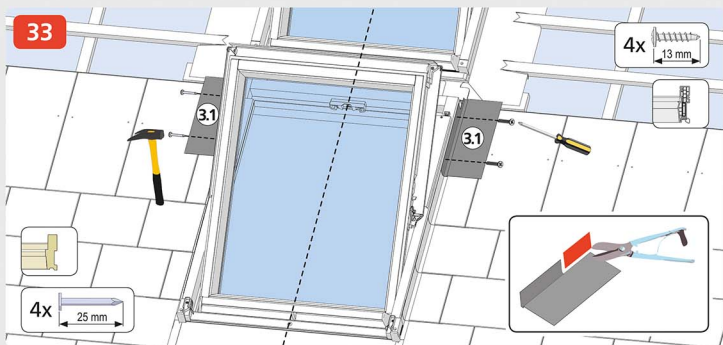
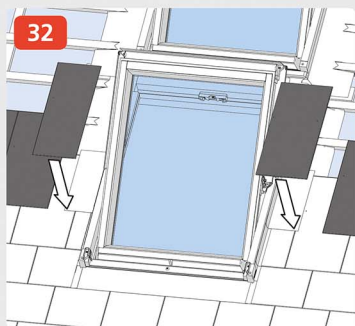
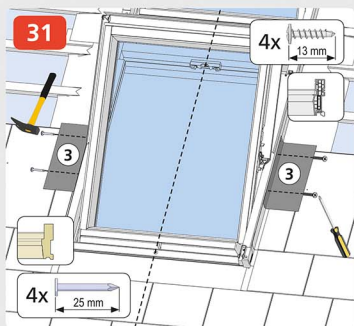
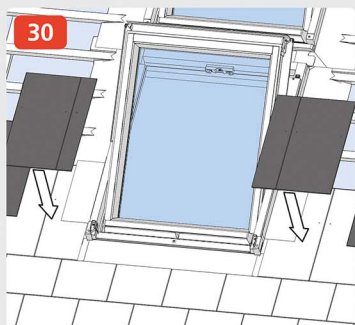
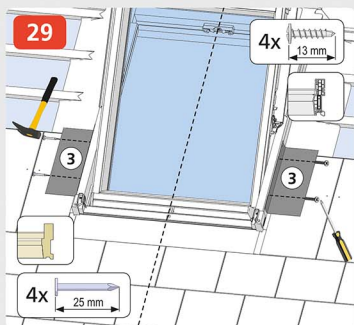

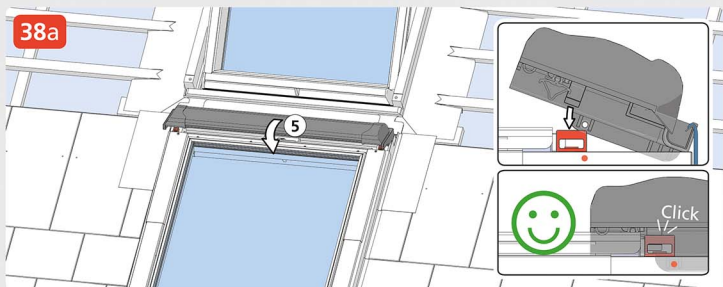
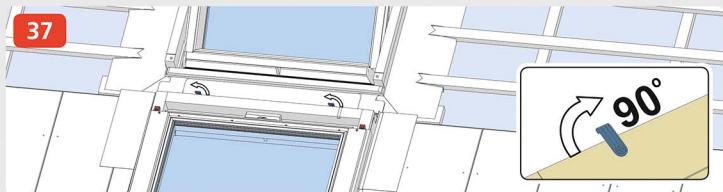
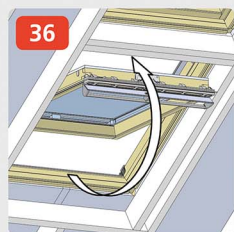
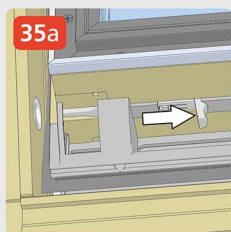
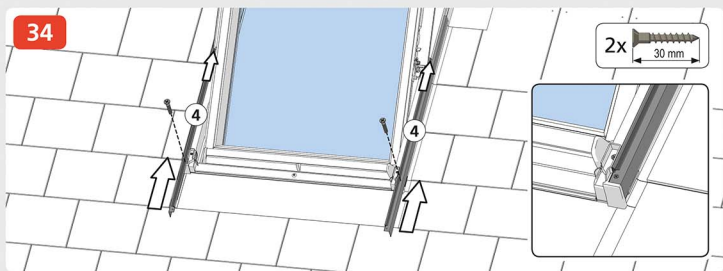

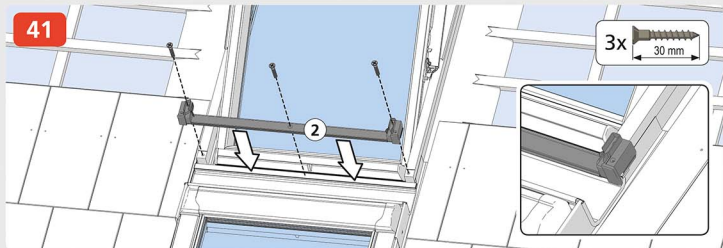
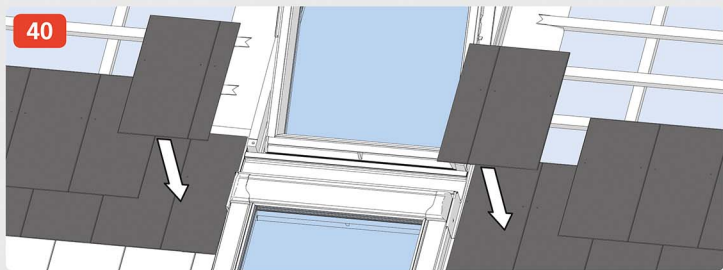
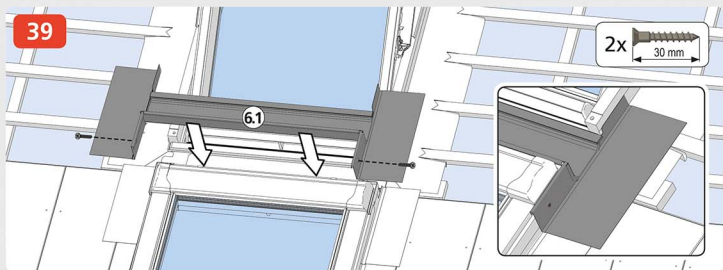
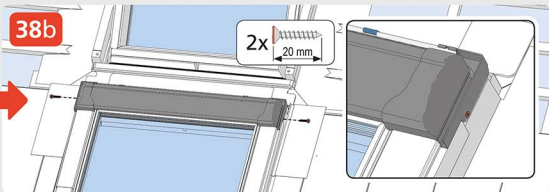
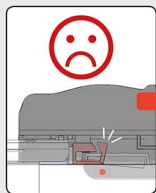

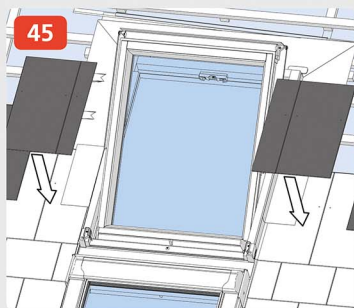
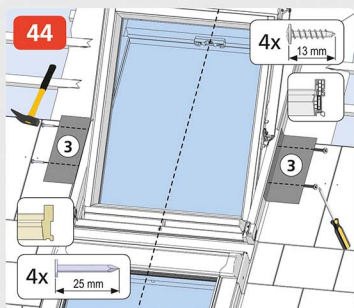
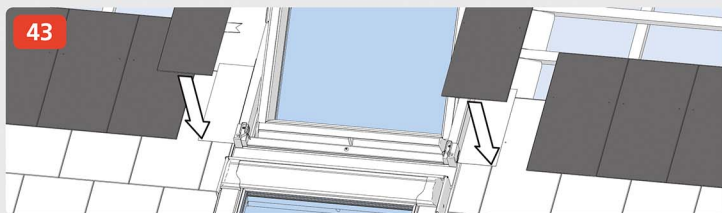
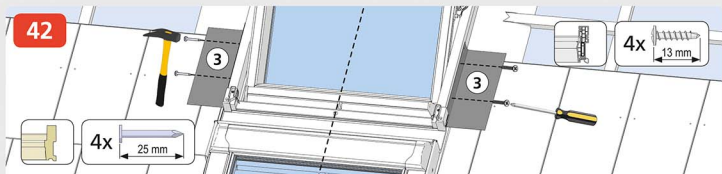
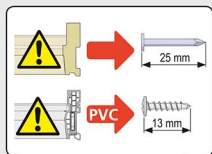

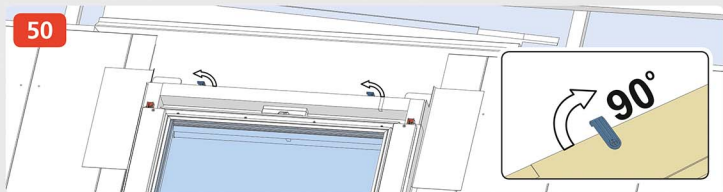
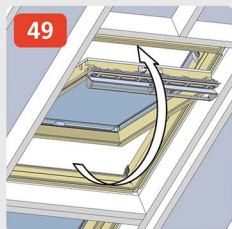
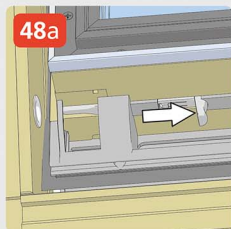
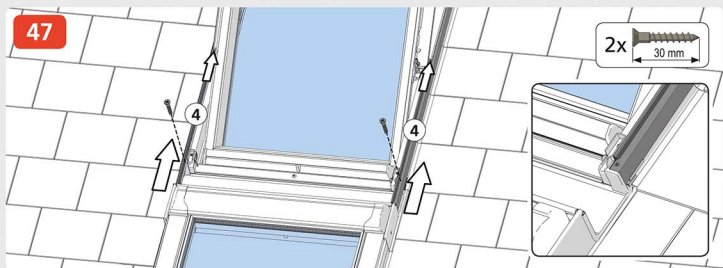
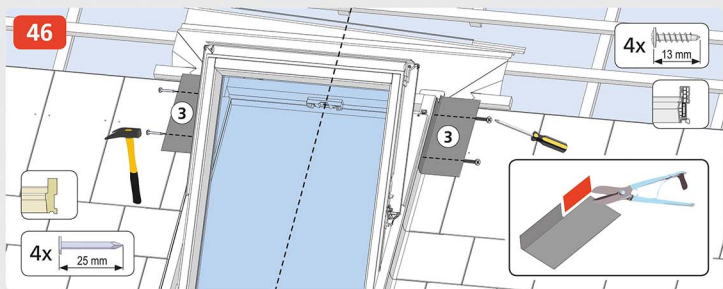

51a

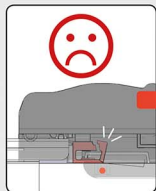
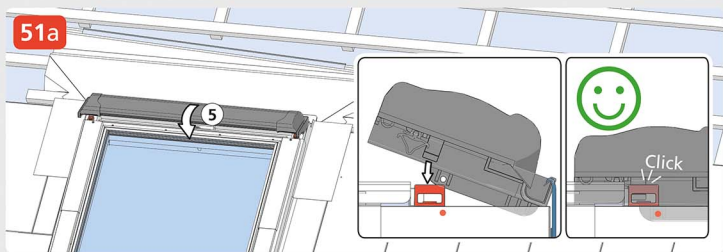

51b

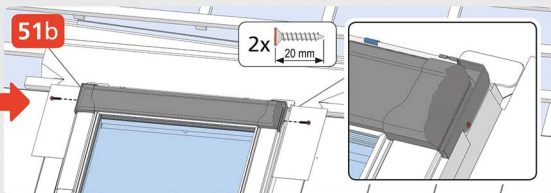

52

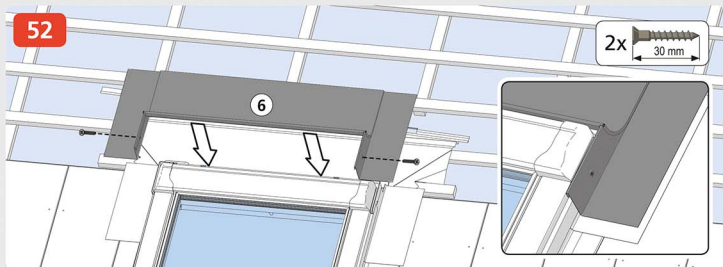

53

