

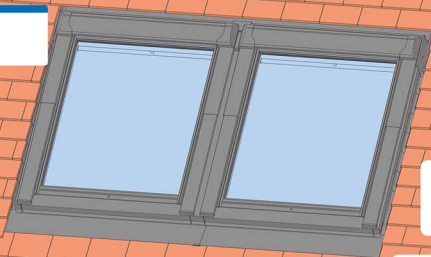

C-PTRF 18

ST 18

PVC



Futuretherm Technology™

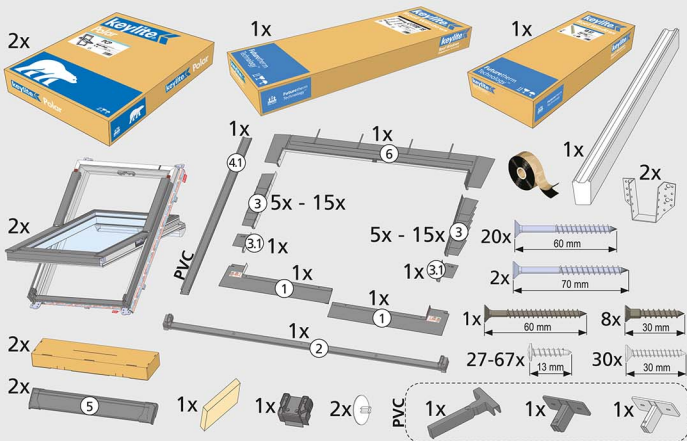

 $Z = 100 \text{ mm}$

max 15 mm

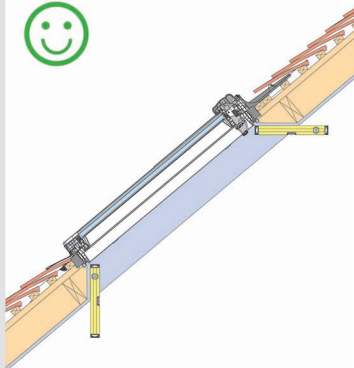
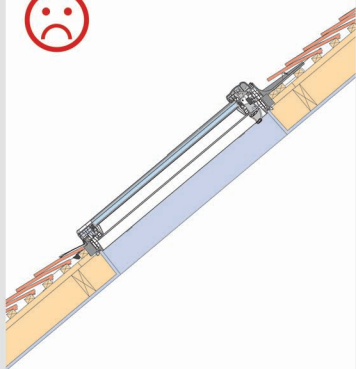
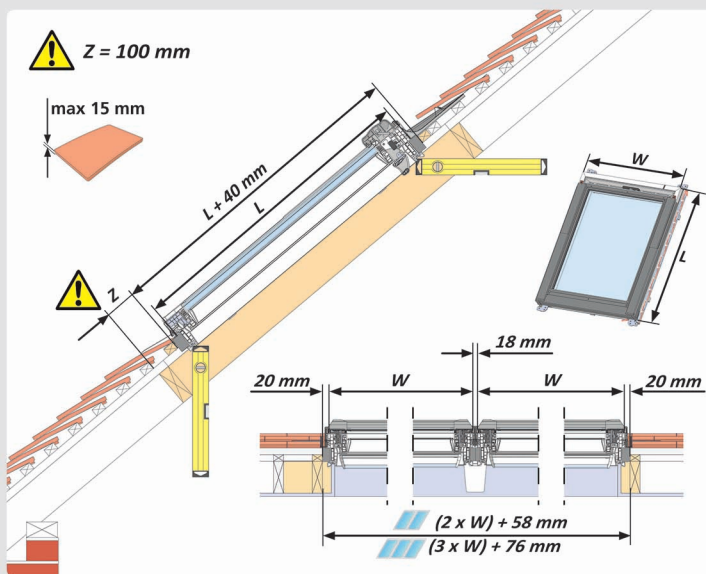

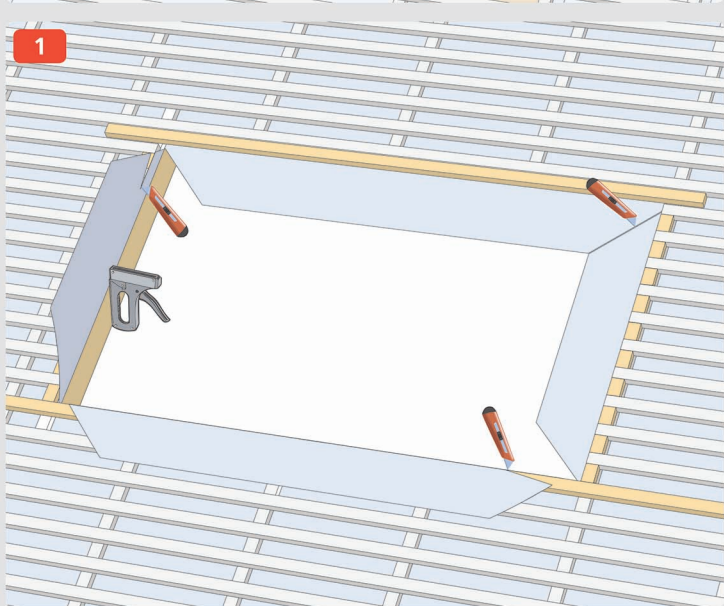
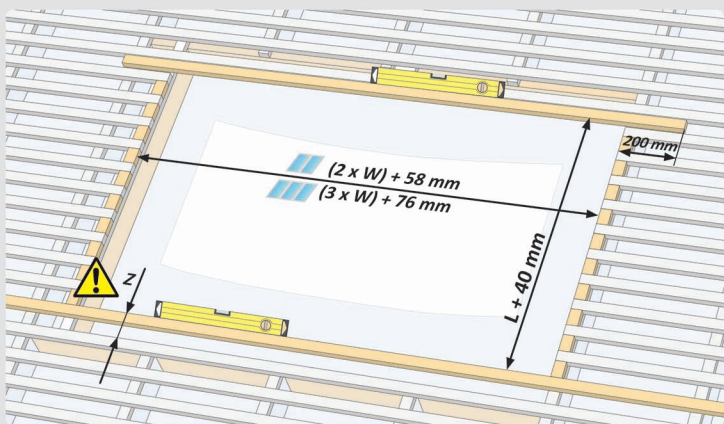

2a

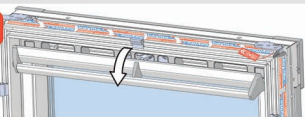

PTH / PFE

PCP
L = 1400 mmPCP
W = 1340 mm

2b

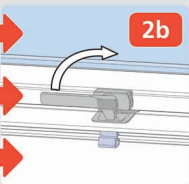

3

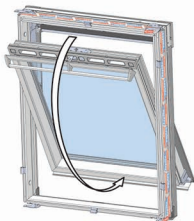

4

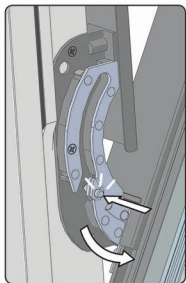

5

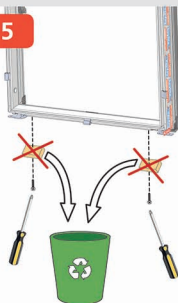

6

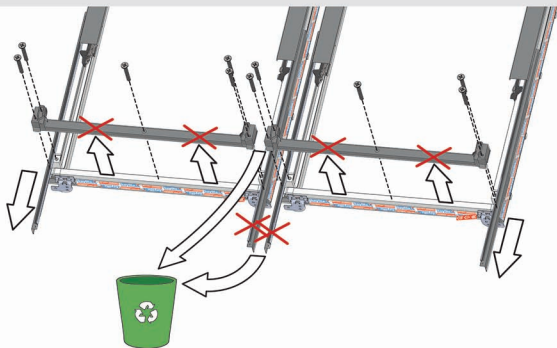

7

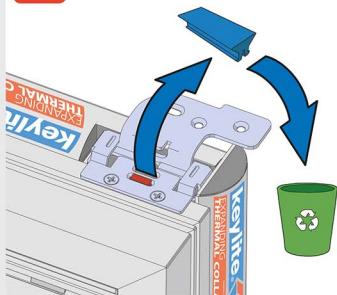

8

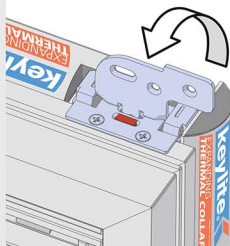

9

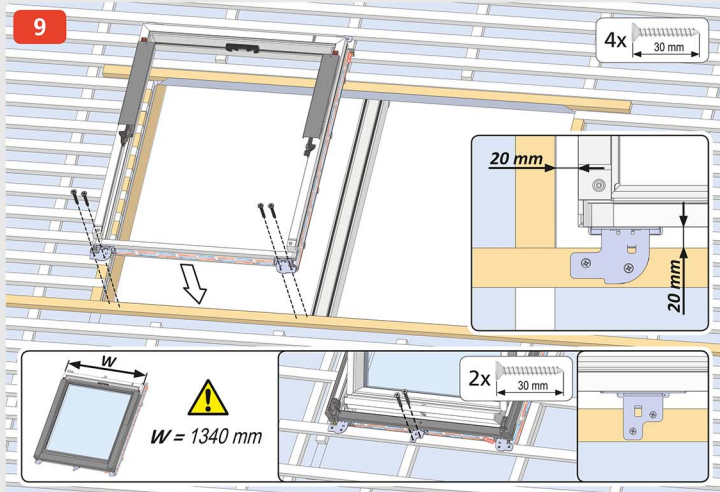

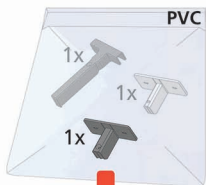

10

4x 30 mm

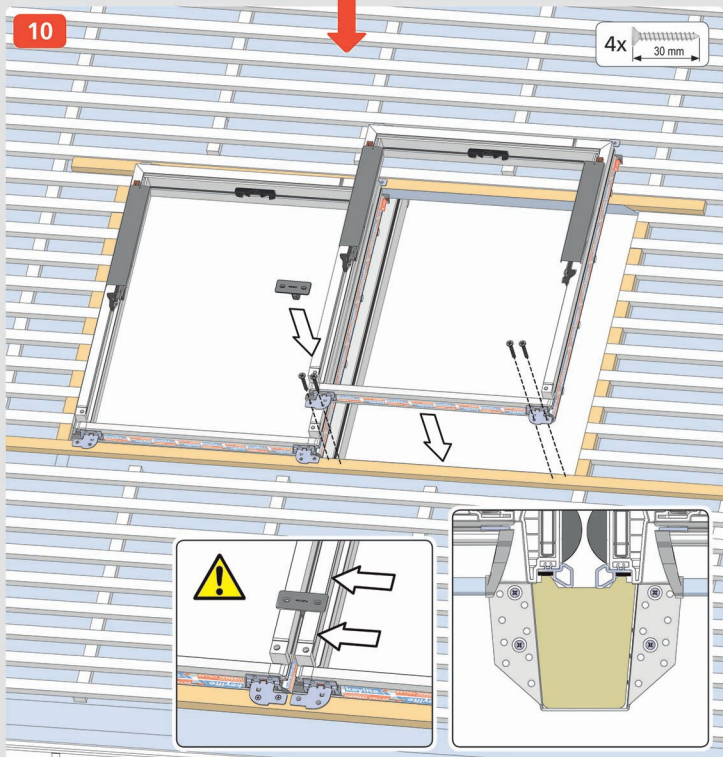

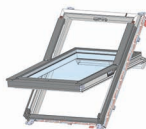

11a

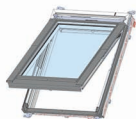
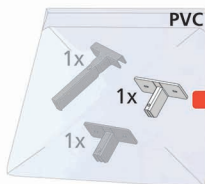
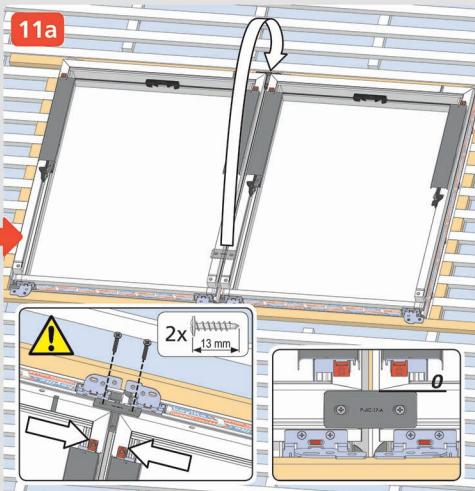

11b

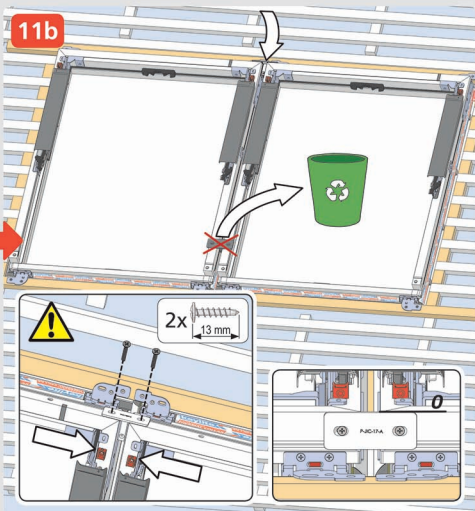

12

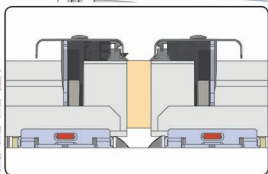
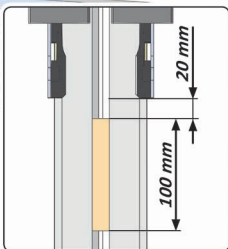
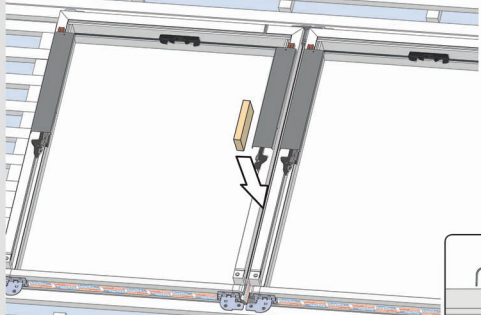

13

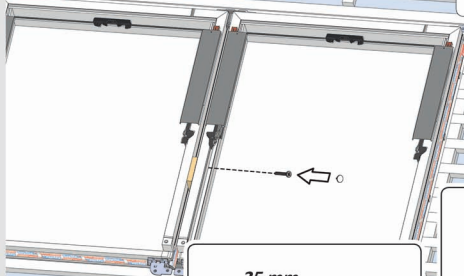

1x



1x

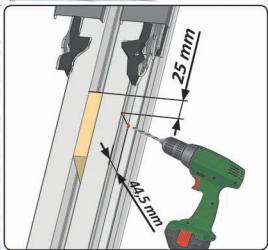
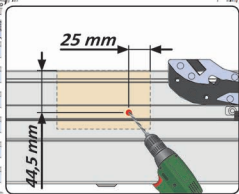
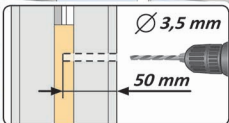
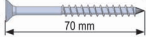

14

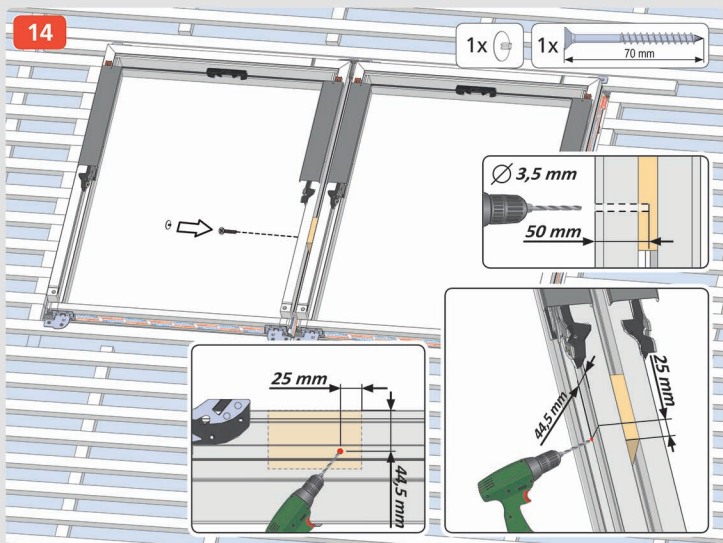

15

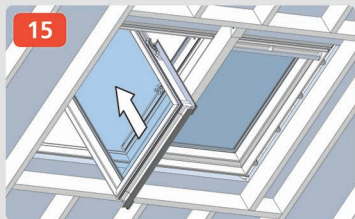

16

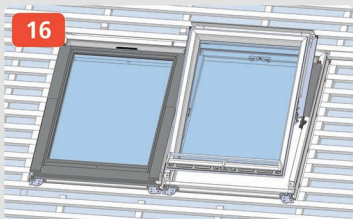

17

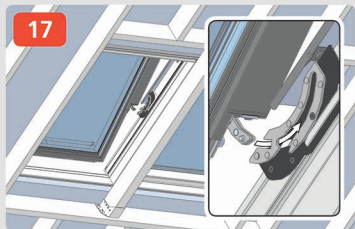

18

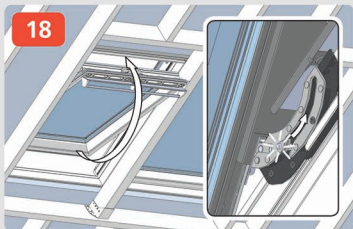

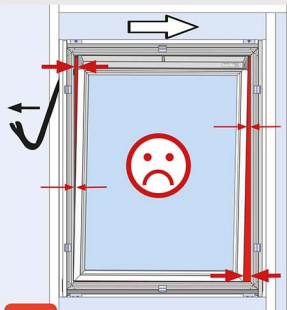

19

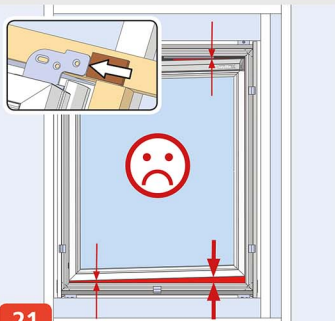

21

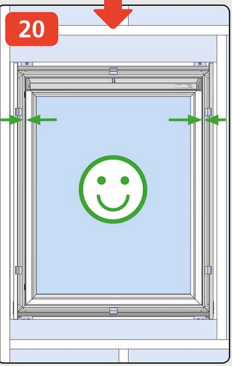
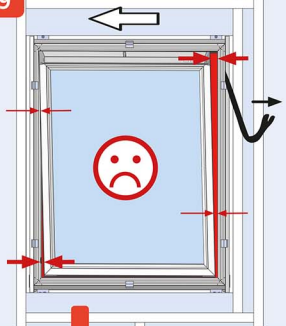

20

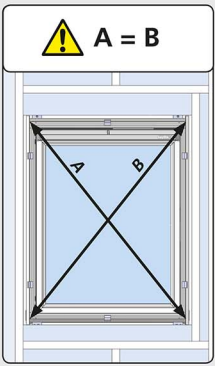

! A = B

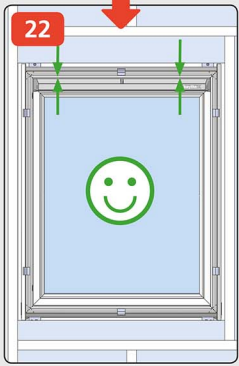

22

23

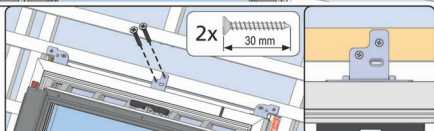
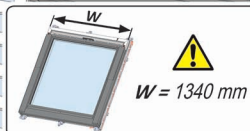
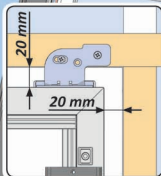
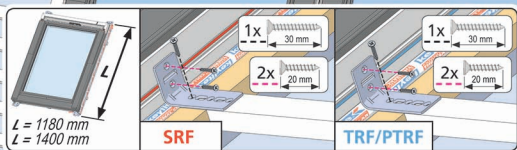
8x  30 mm

24

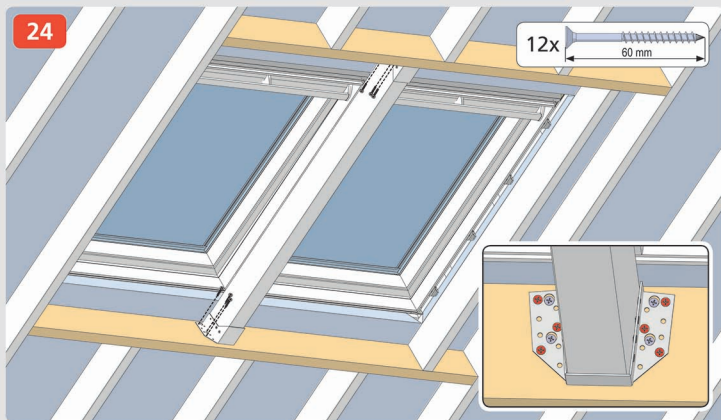
12x  60 mm

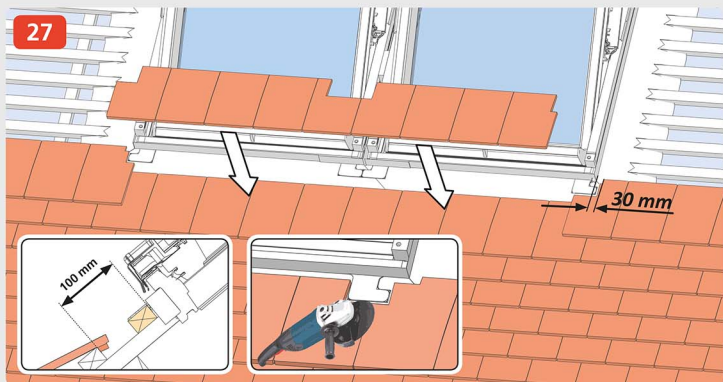
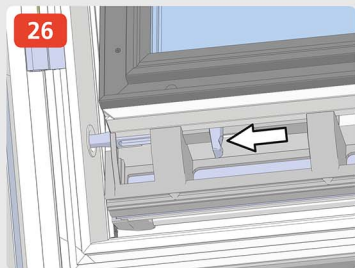
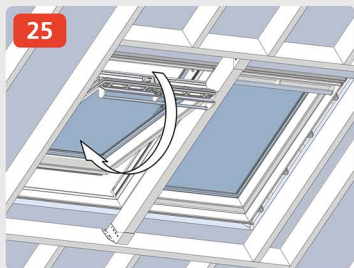
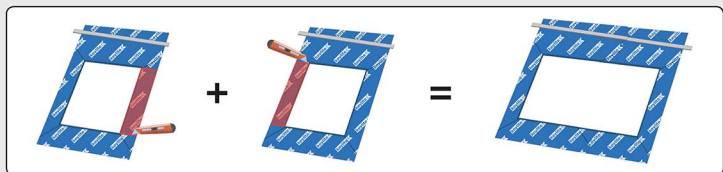

28

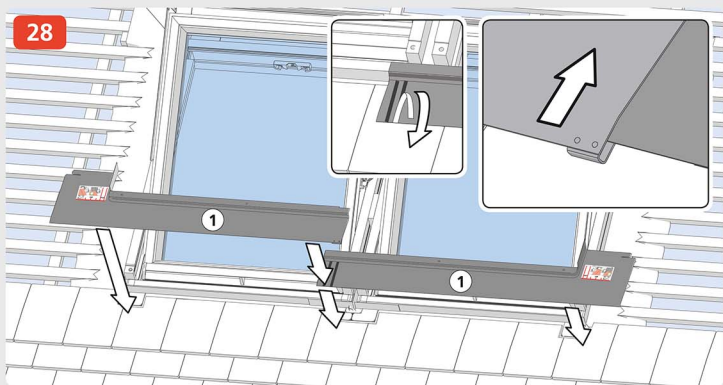

29

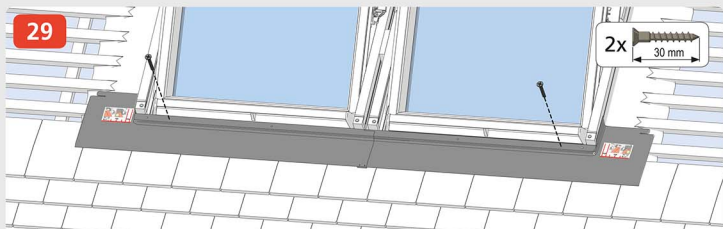

30

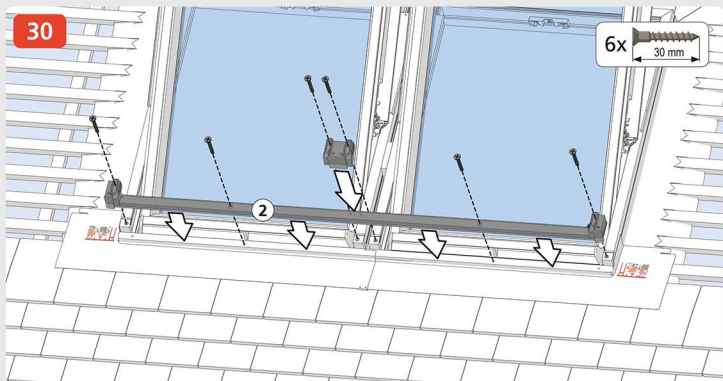

31

2x 30 mm

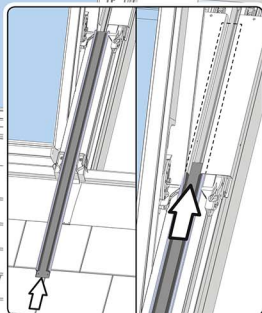
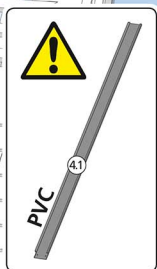

32

4x 13 mm

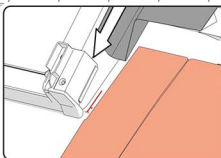
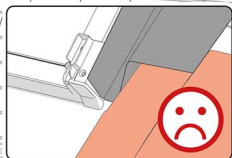
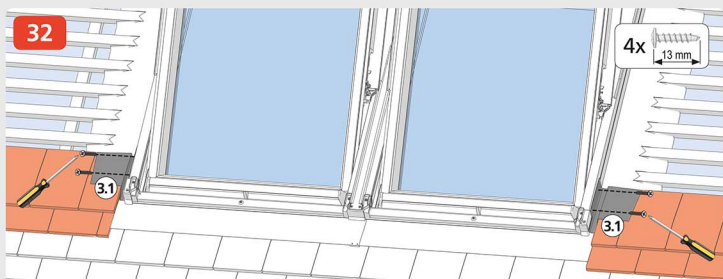

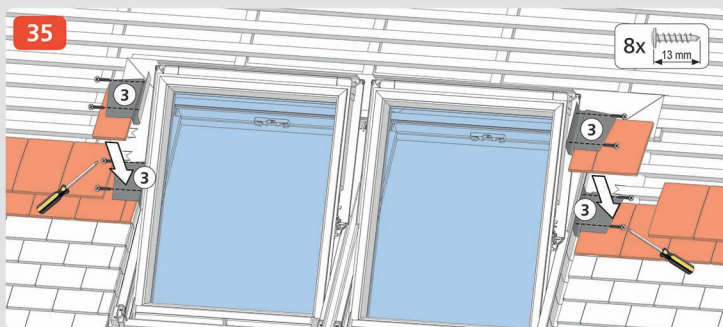
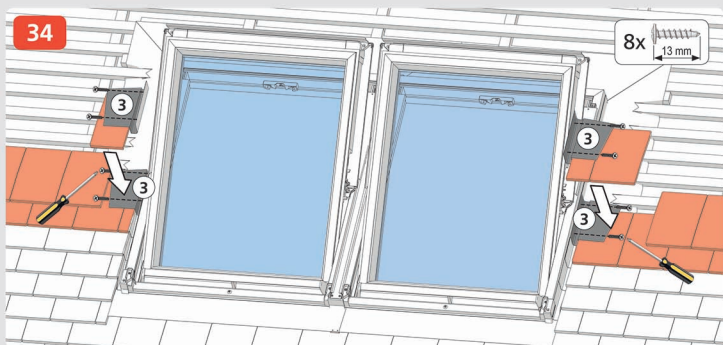
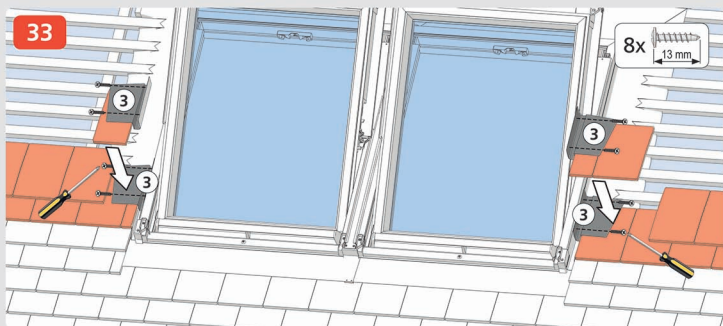

36

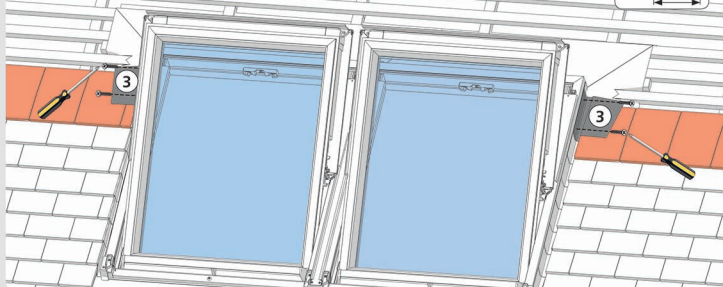
4x
13 mm

37

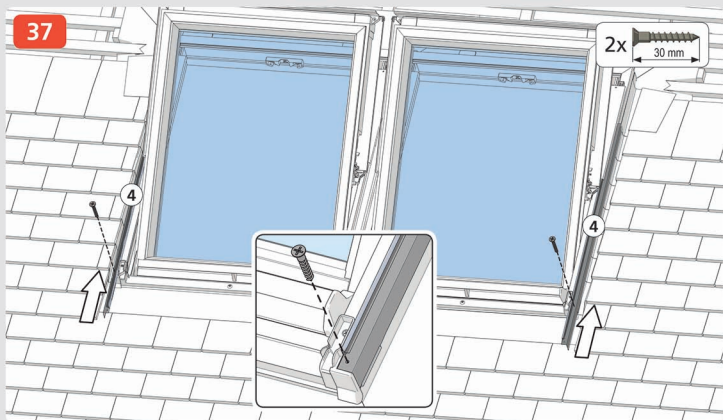
2x
30 mm

38a

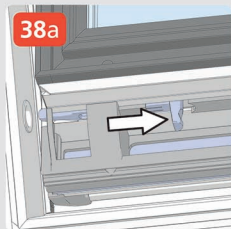

38b

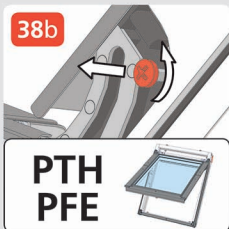

39

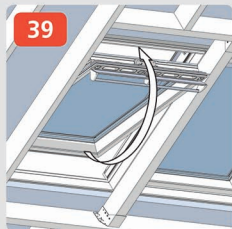

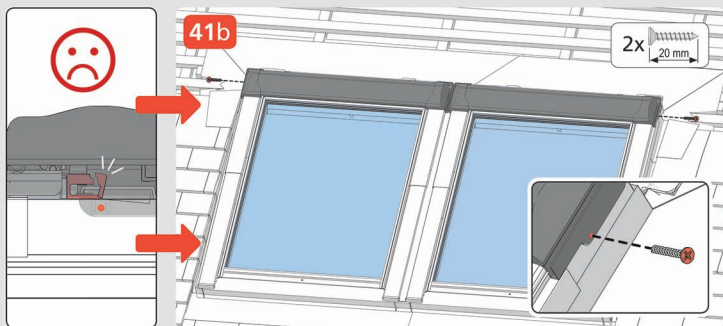
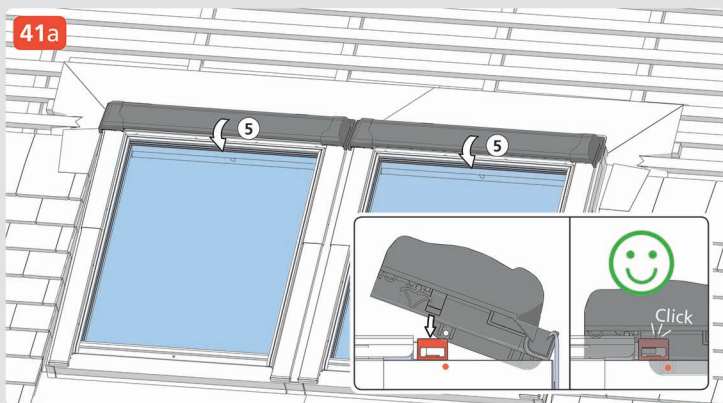
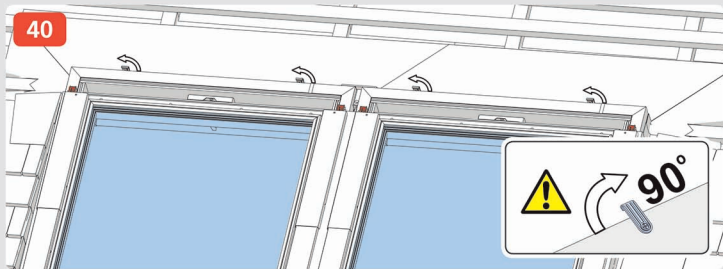

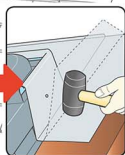
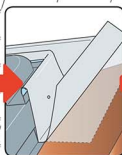
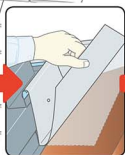
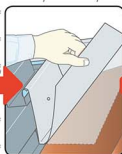
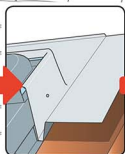
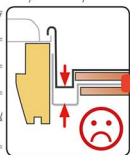
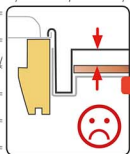
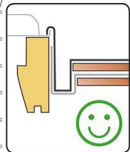
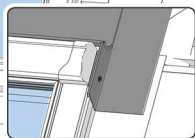
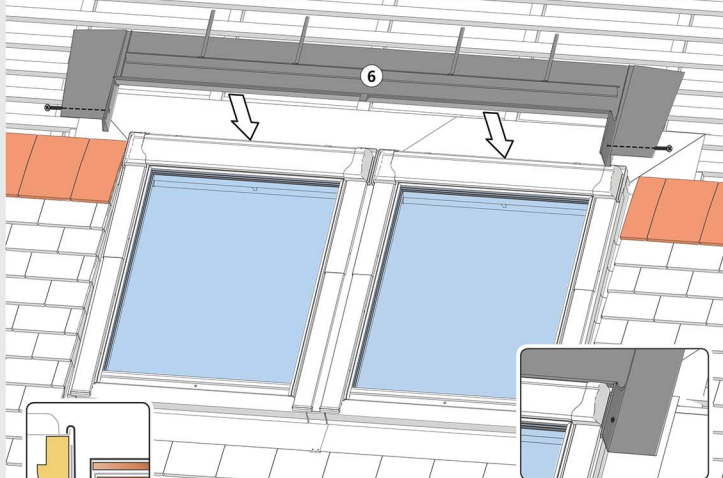

43

1x

60 mm

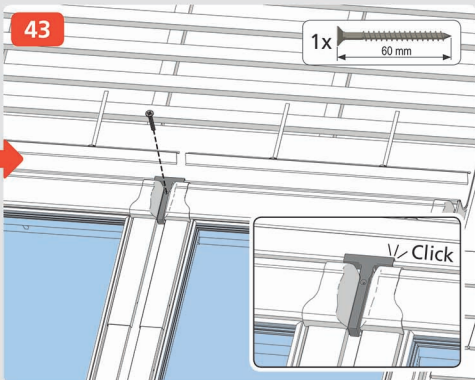
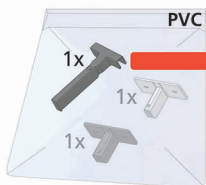

44

