

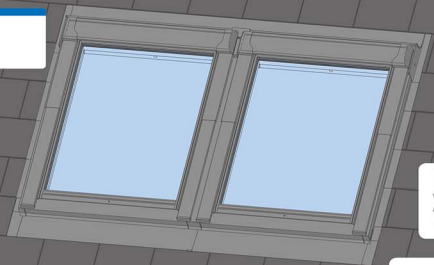

C-SRF 18

ST 18

PVC



3-10 mm



15-90°



Futuretherm Technology™

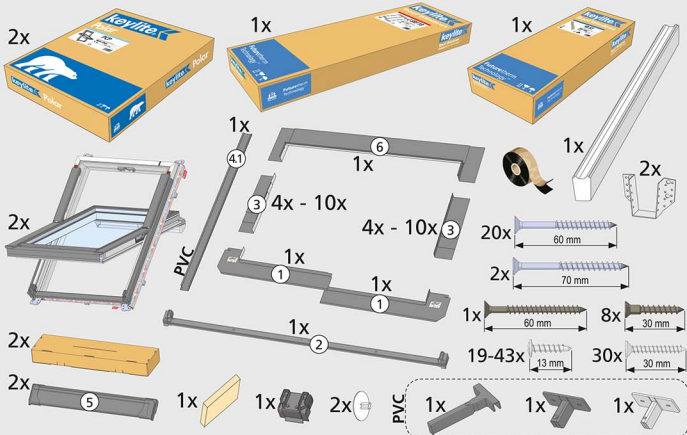

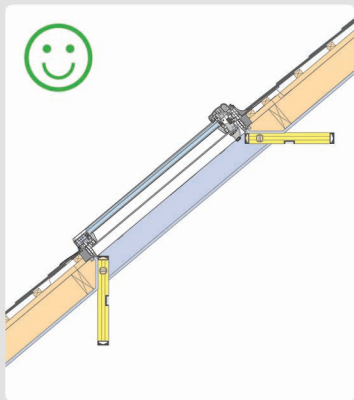
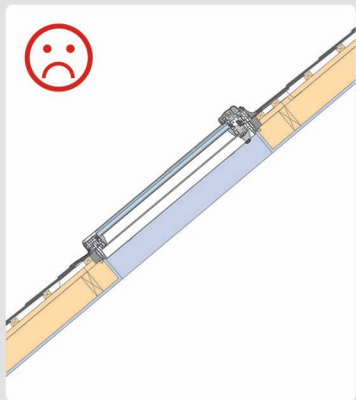
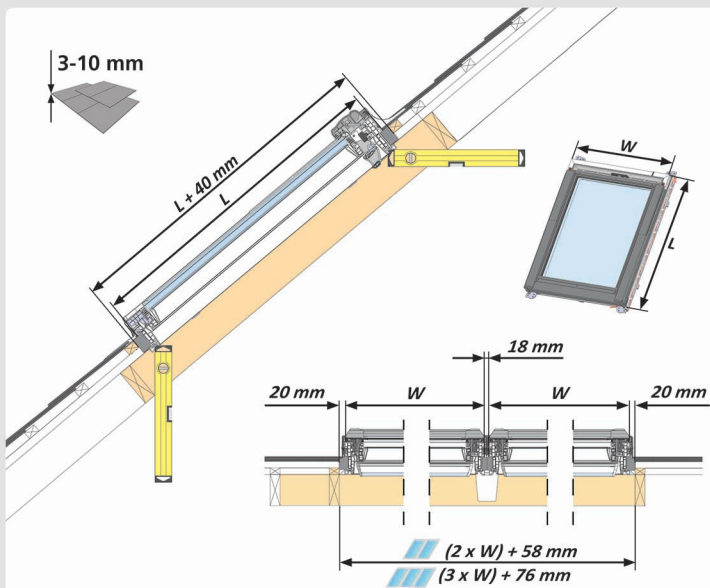

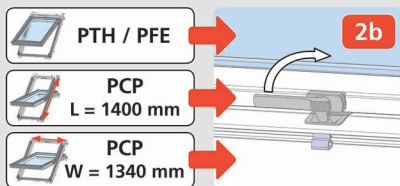
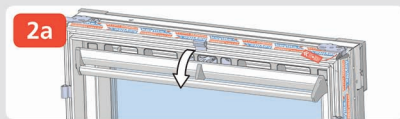
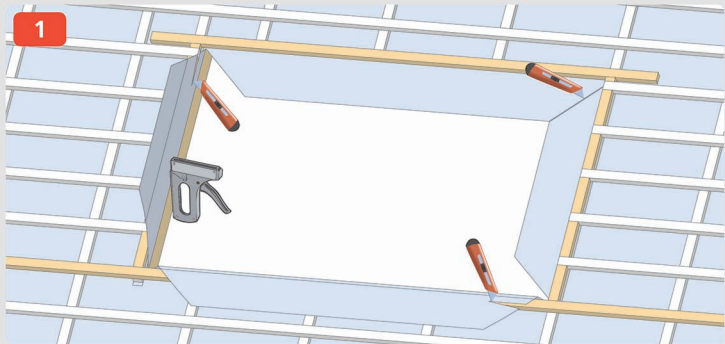
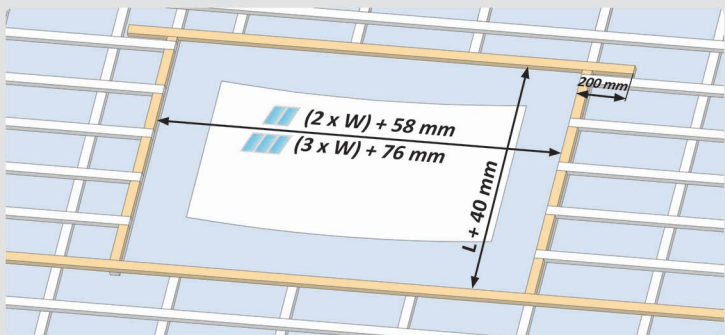

4

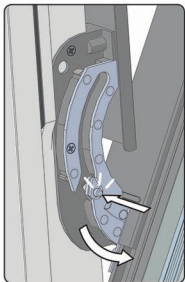

5

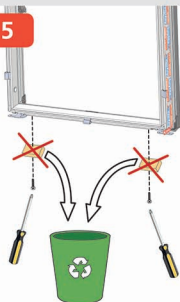

6

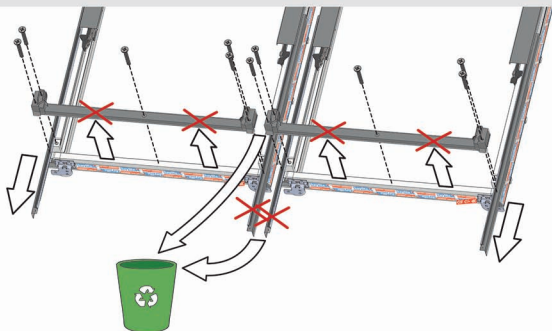

7,8,9,10 mm

7a

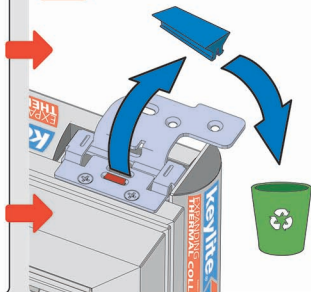

8a

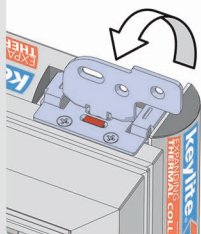

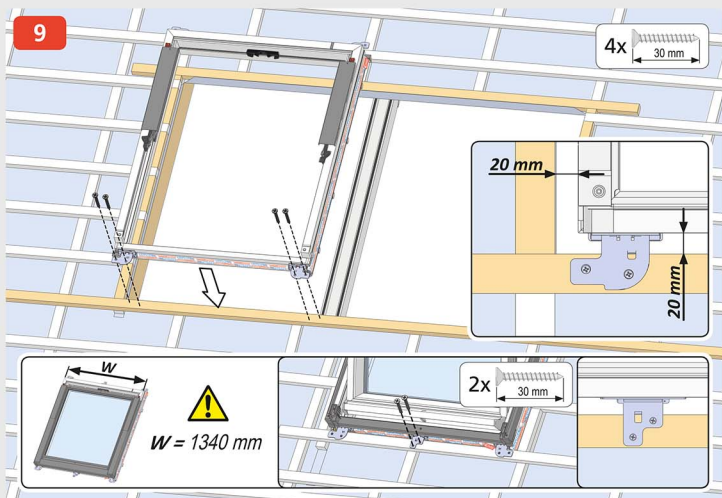
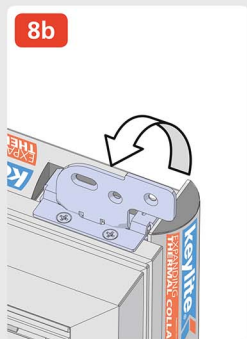
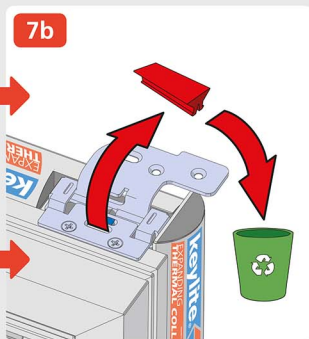
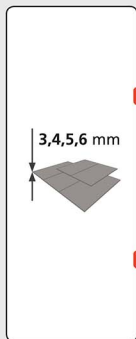

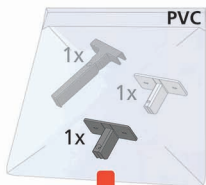

10

4x 30 mm

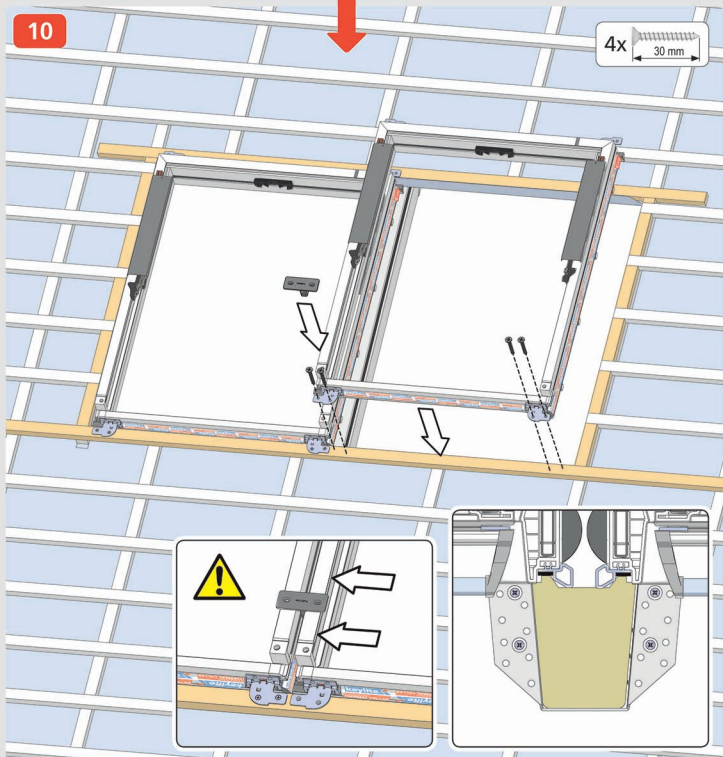

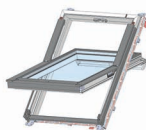

11a

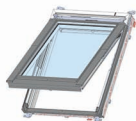
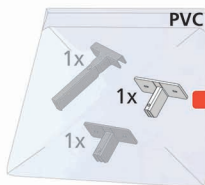
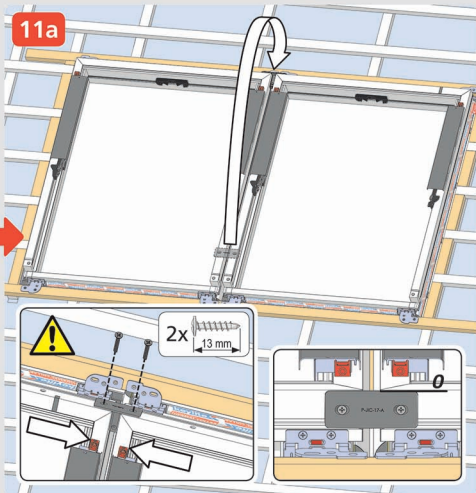

11b

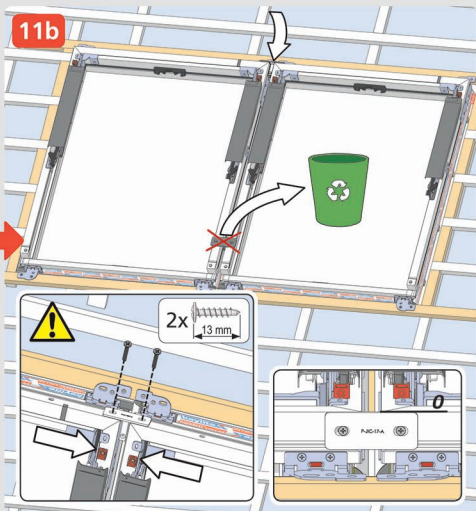

12

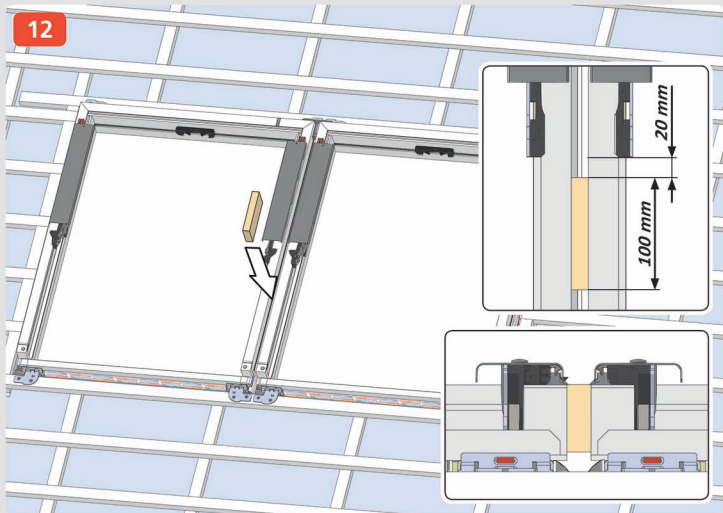

13

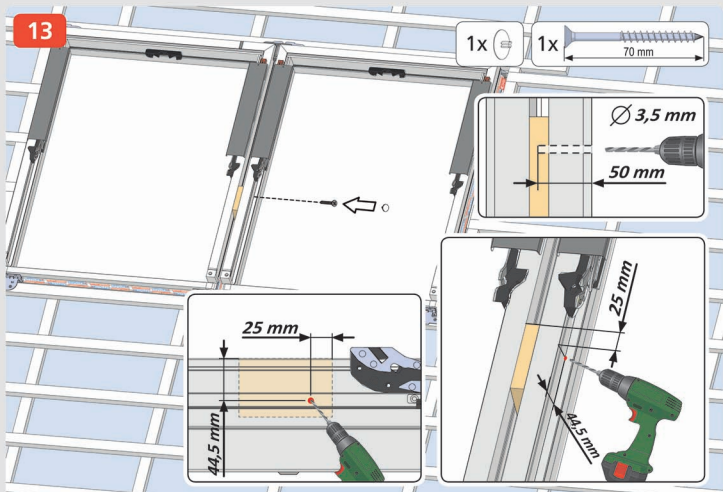

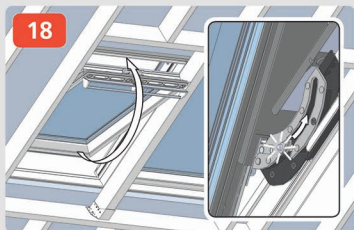
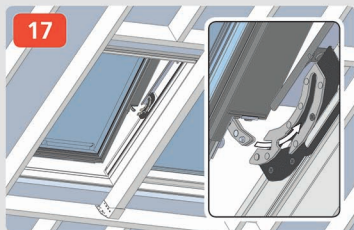
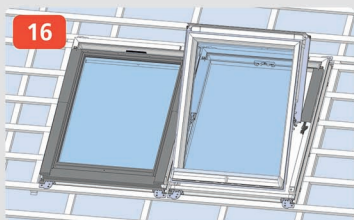
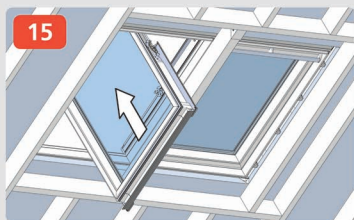
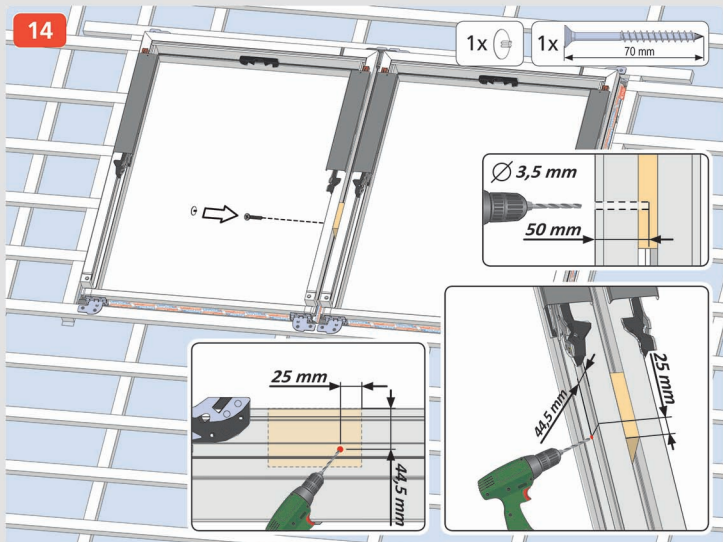

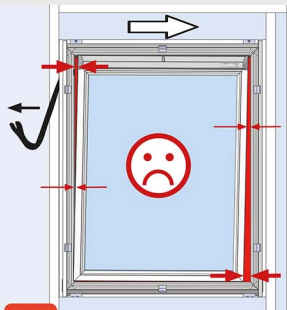

19

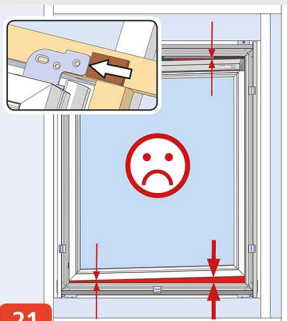

21

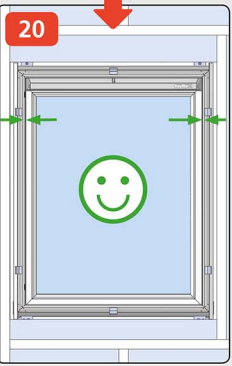
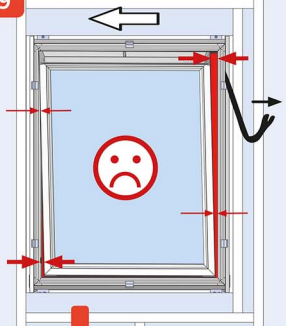

20

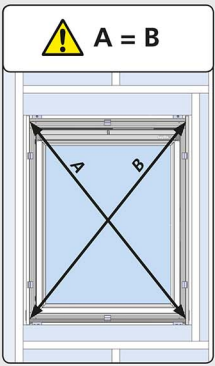

! A = B

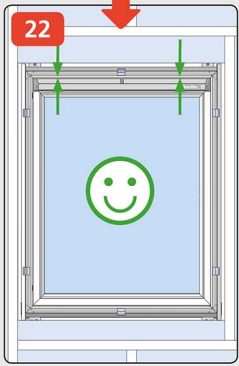

22

23

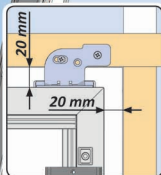
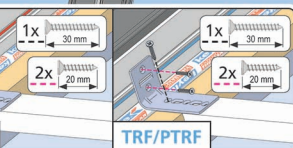
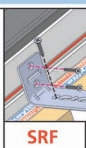
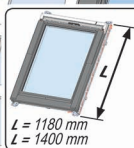
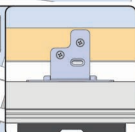
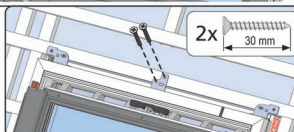
8x  30 mm $W = 1340 \text{ mm}$ 

24

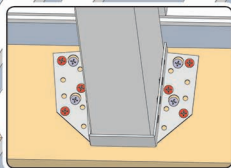
12x  60 mm

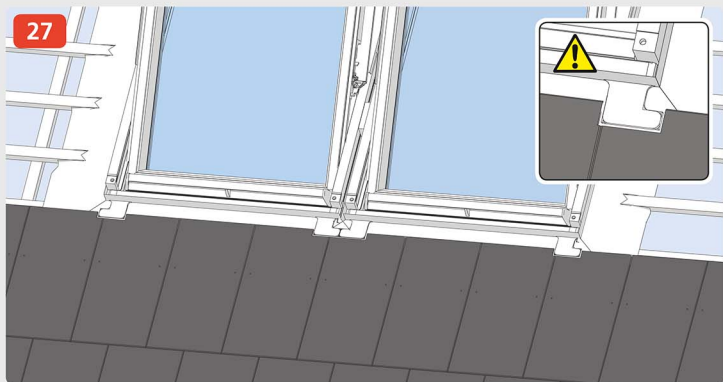
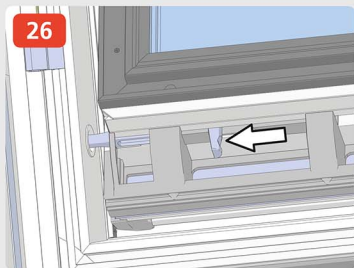
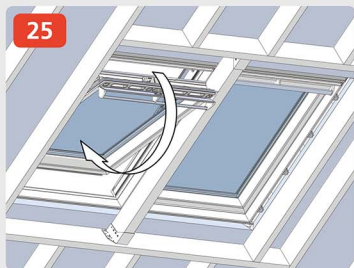
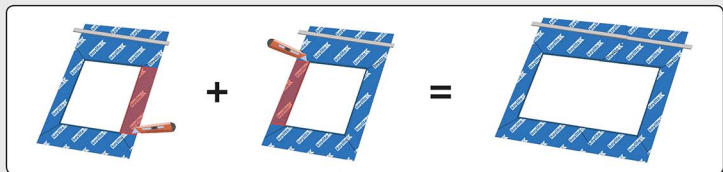

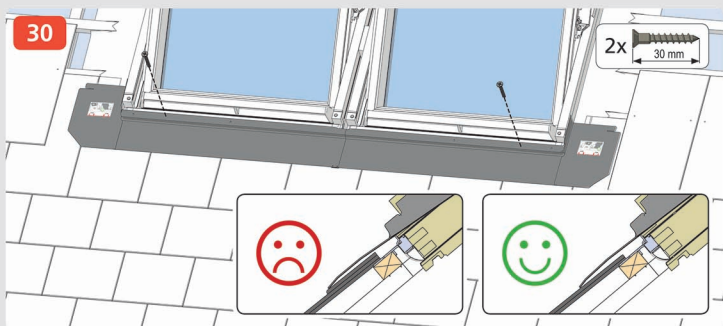
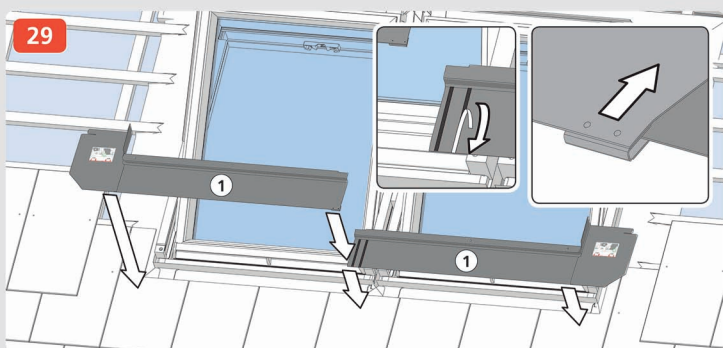
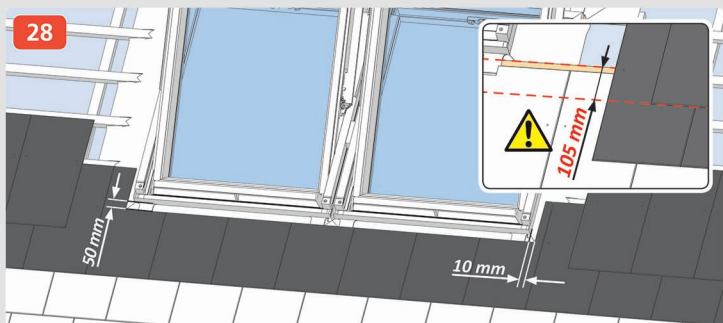

31

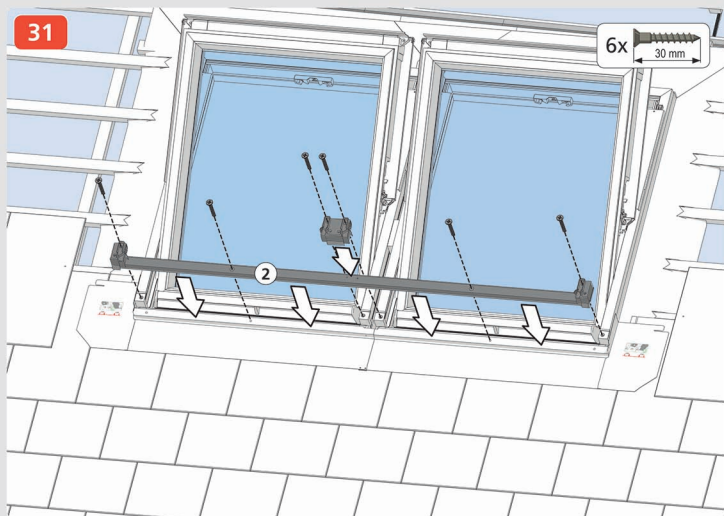

32

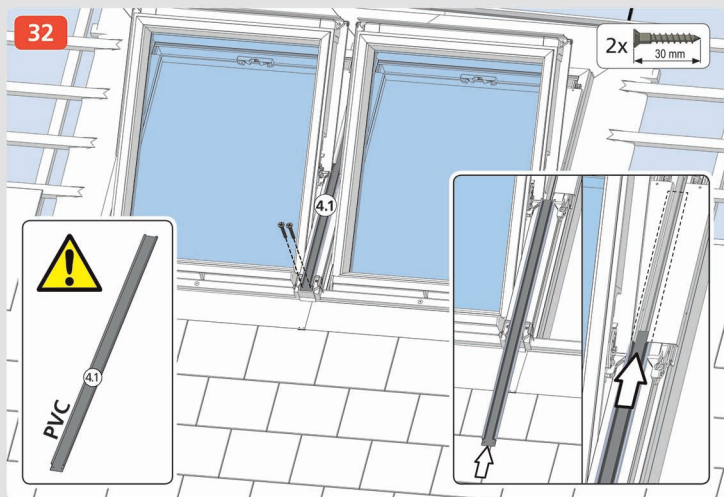

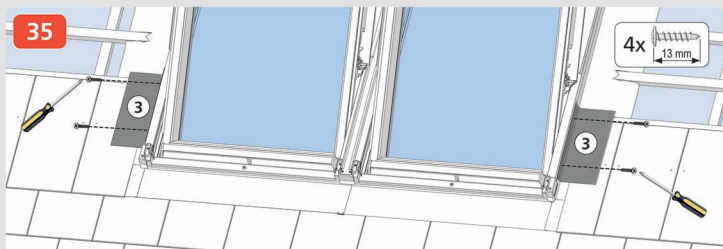
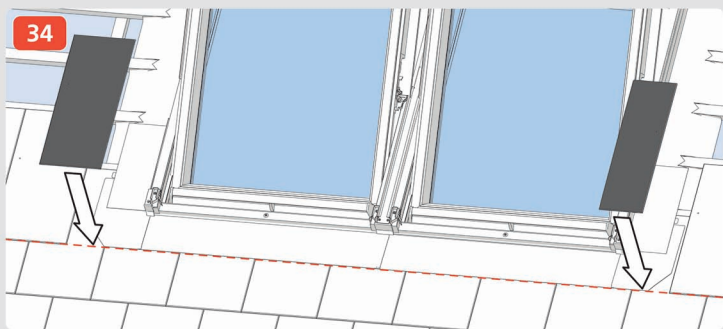
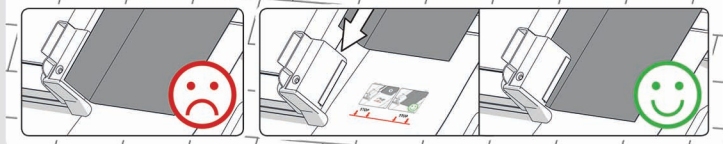
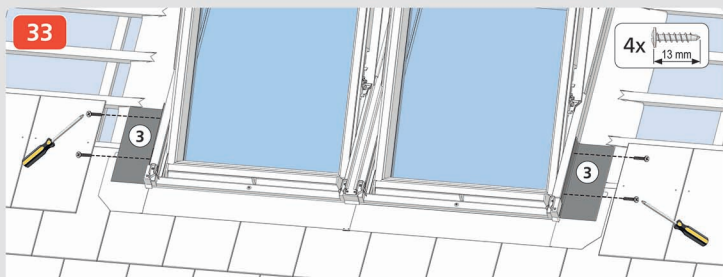

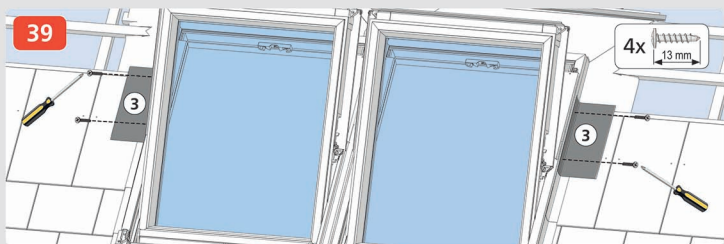
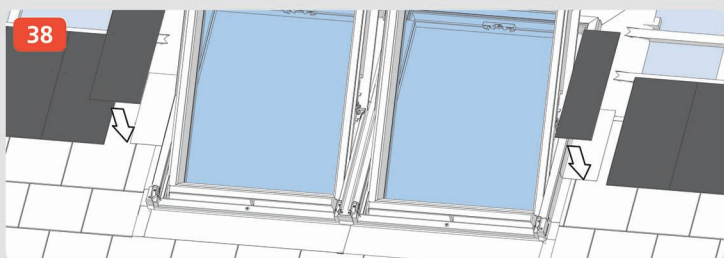
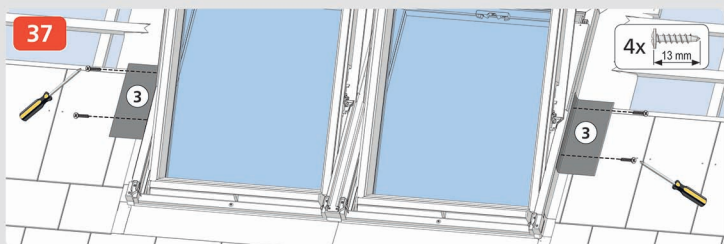
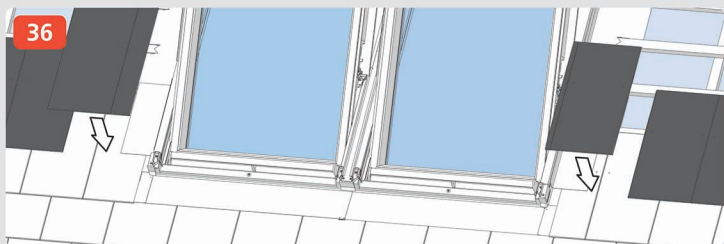

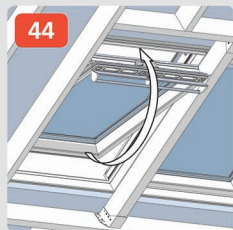
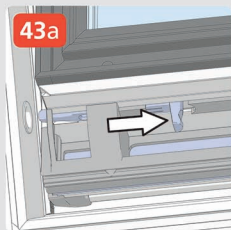
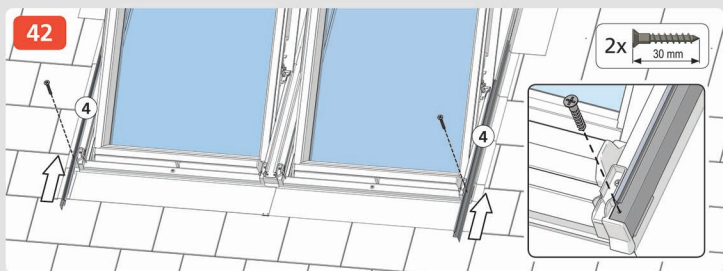
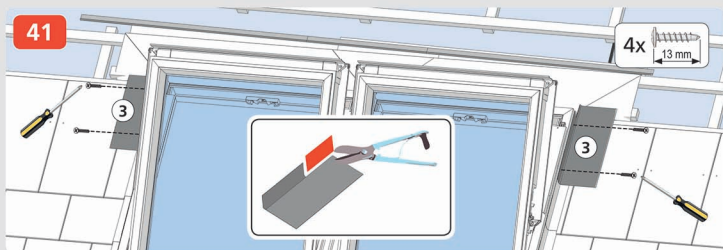
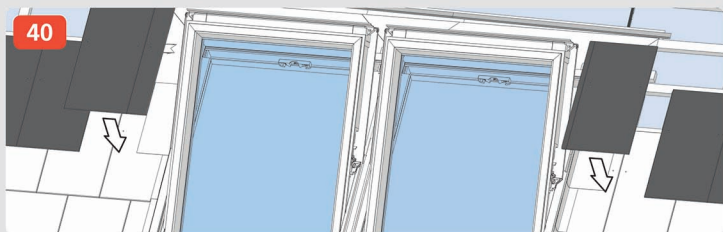

45

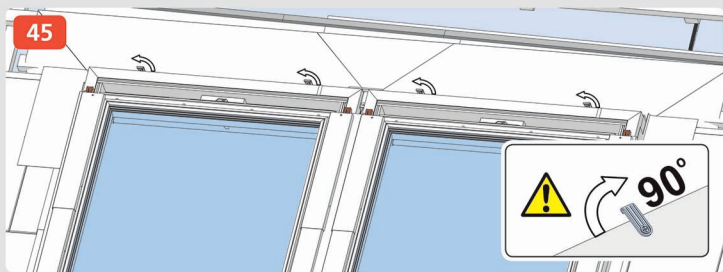

46a

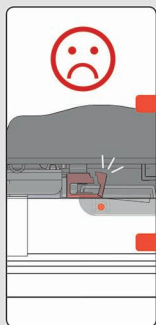
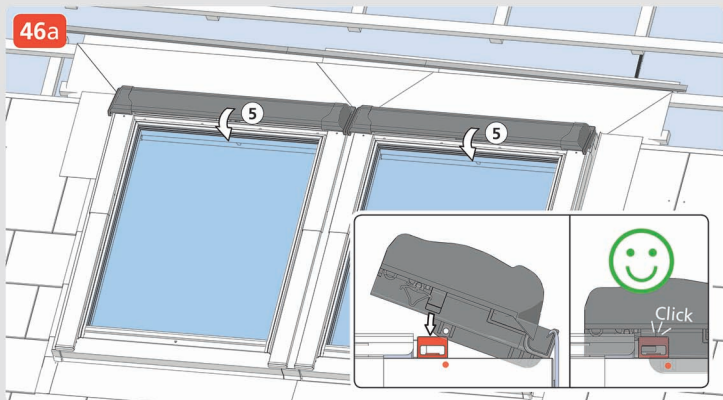

46b

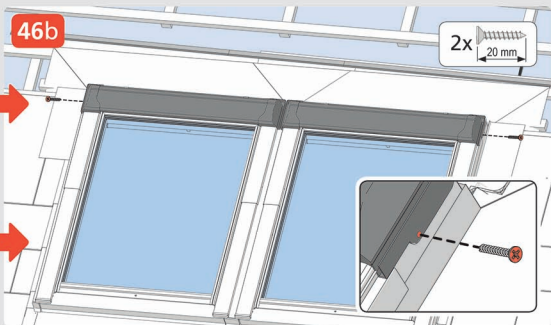

47

2x

30 mm

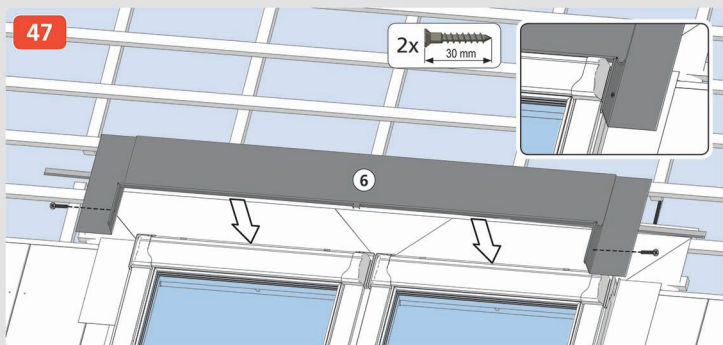

48

1x

60 mm

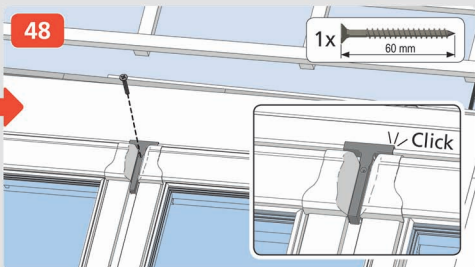
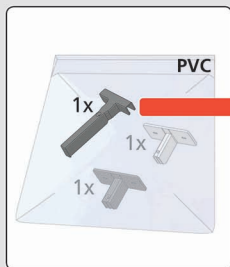

49

