

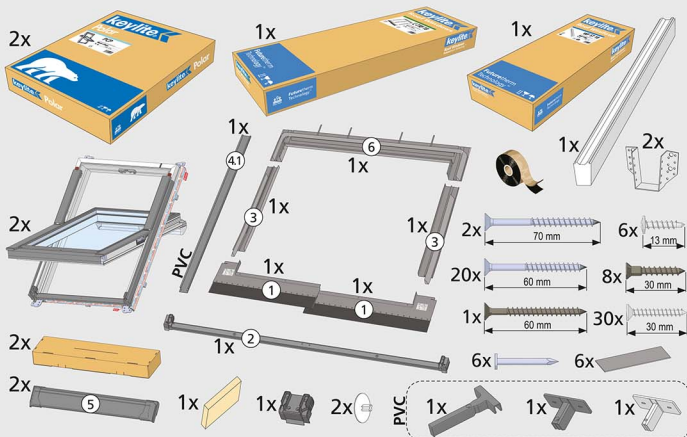

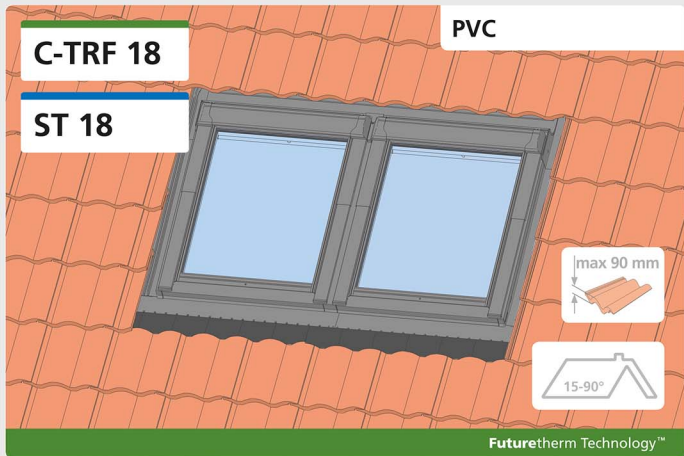

C-TRF 18

ST 18

PVC



 $Z = 120 \text{ mm} - 140 \text{ mm}$

max 90 mm

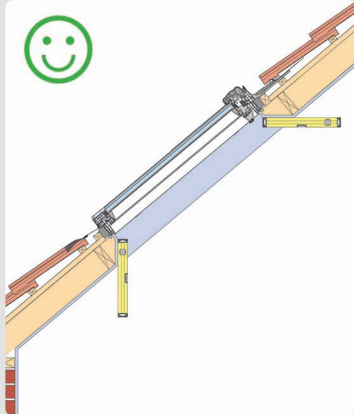
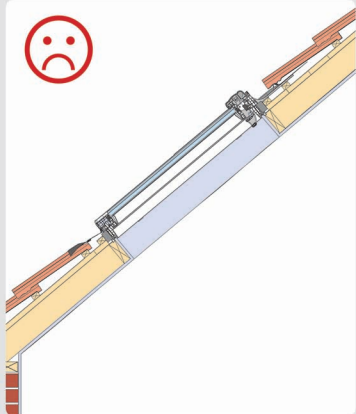
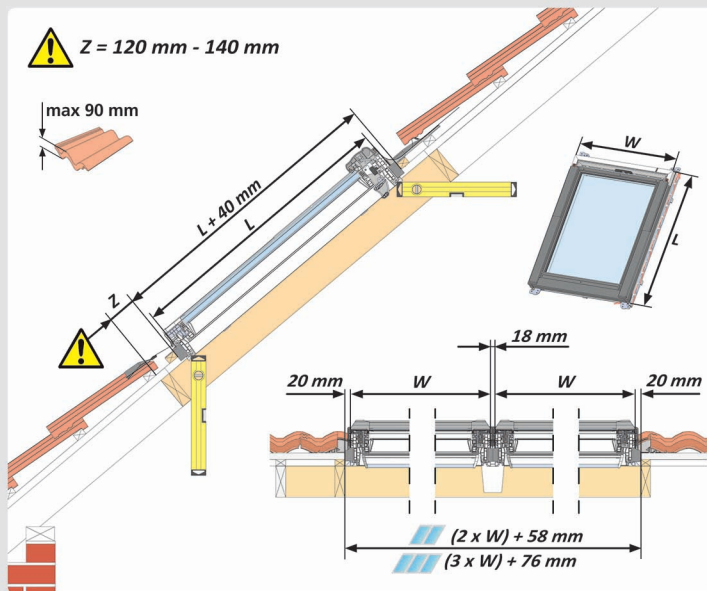

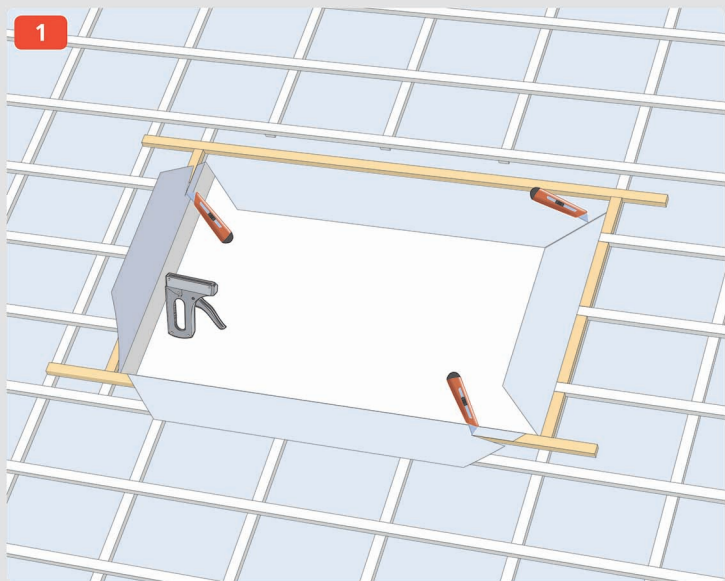
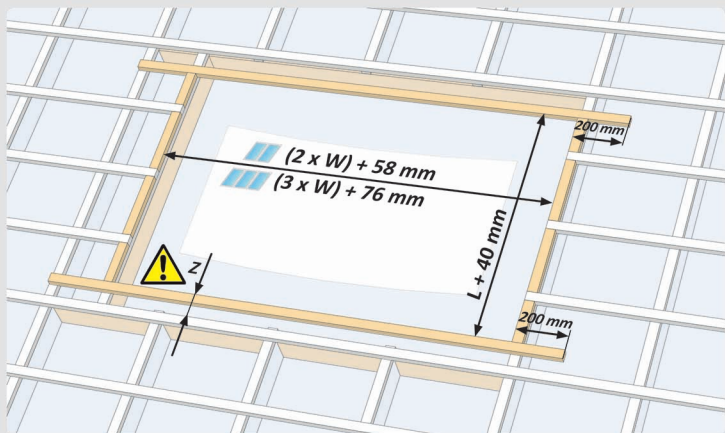

2a

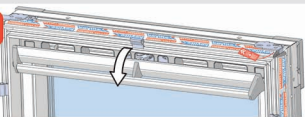

PTH / PFE

PCP
L = 1400 mmPCP
W = 1340 mm

2b

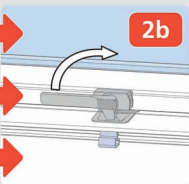

3

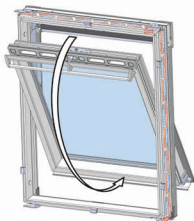

4

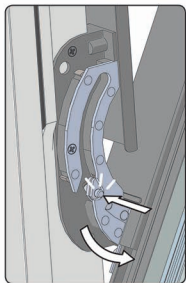

5

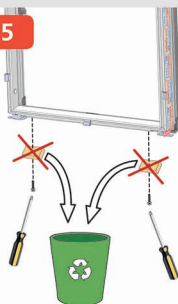

6

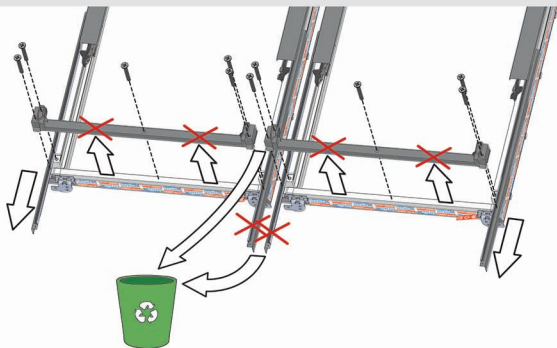

7

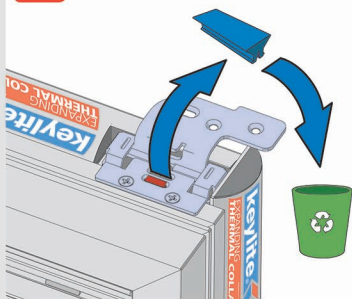

8

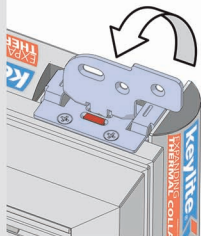

9

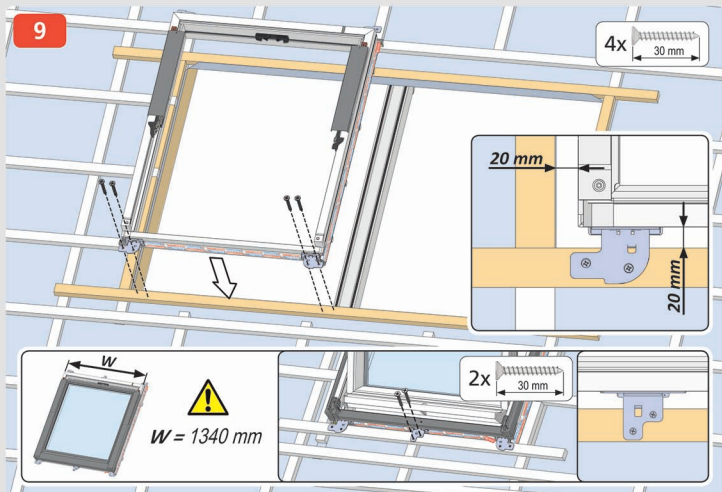

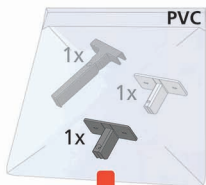

10

4x 30 mm

Four screws are shown, with a dimension line indicating a length of 30 mm.

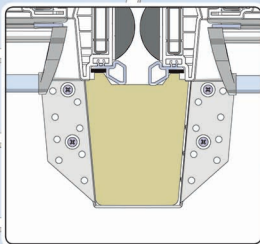
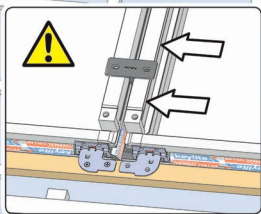
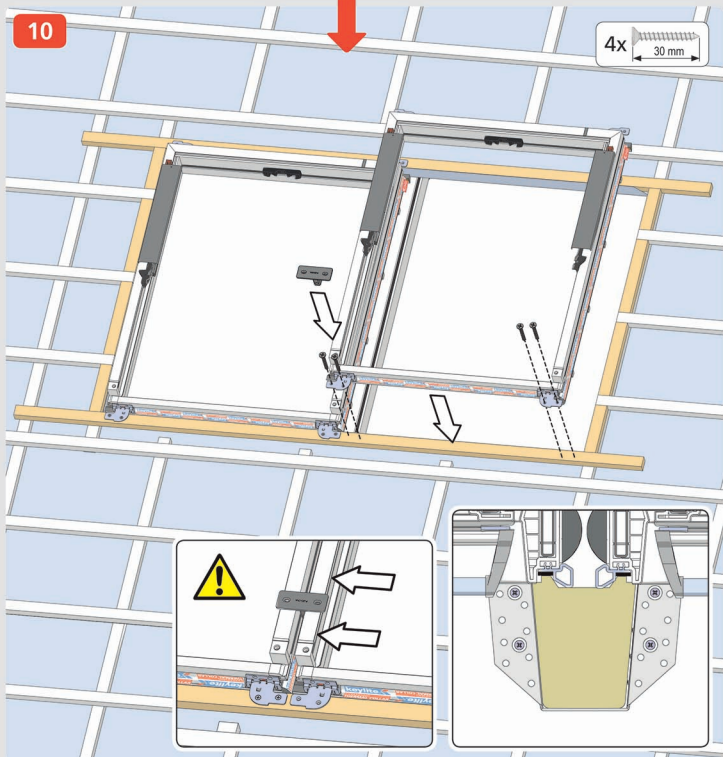



PCP

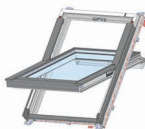

11a

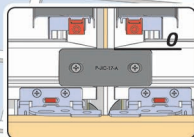
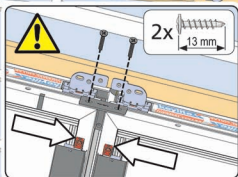
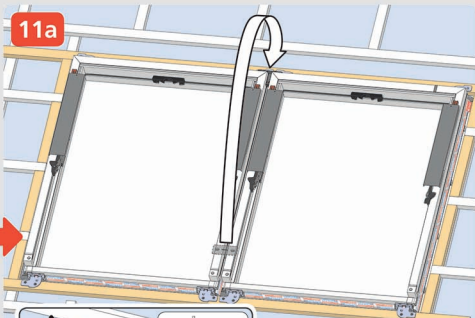

PTH/PFE

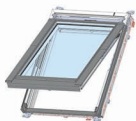
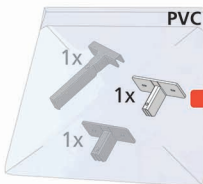

11b

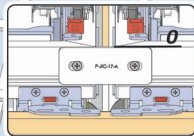
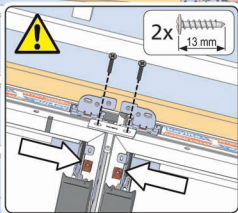
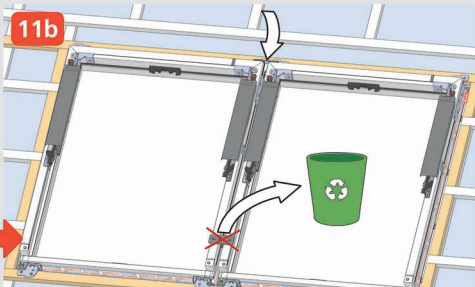

12

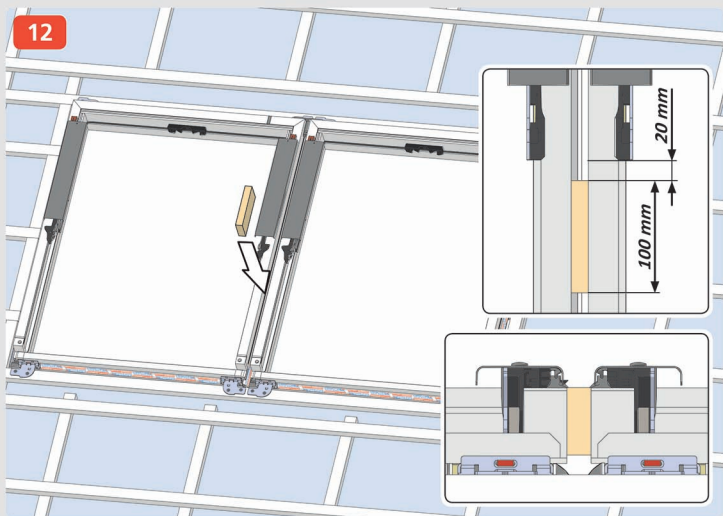

13

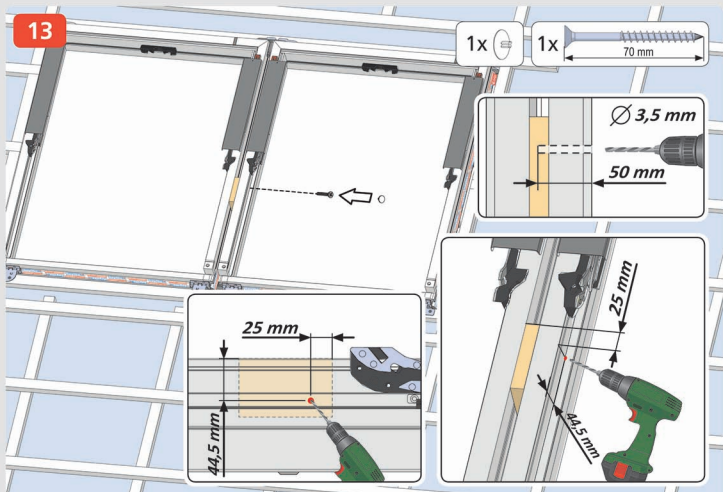

14

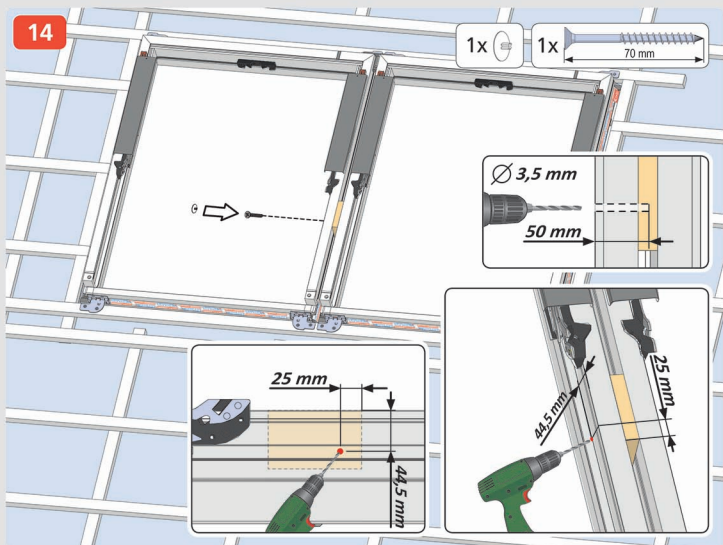

15

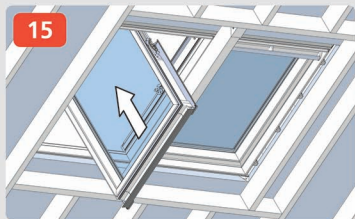

16

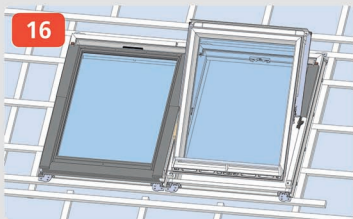

17

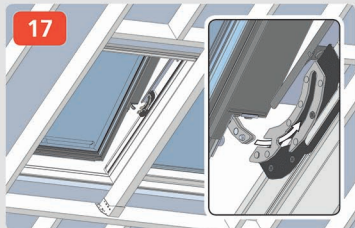

18

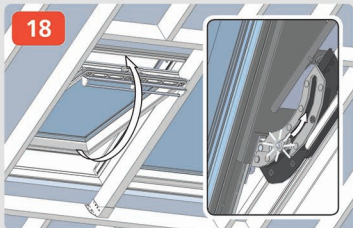

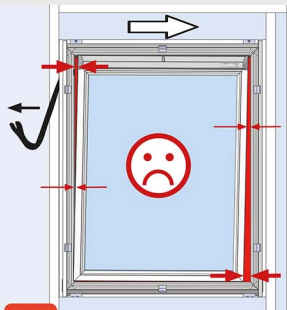

19

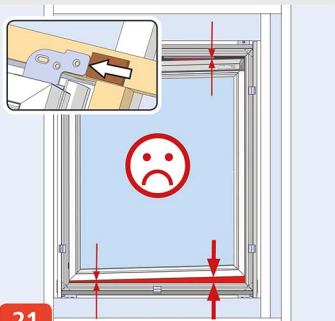

21

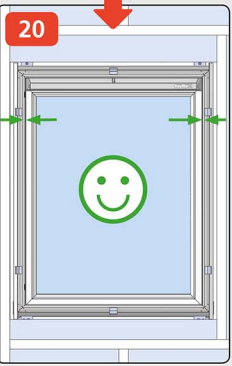
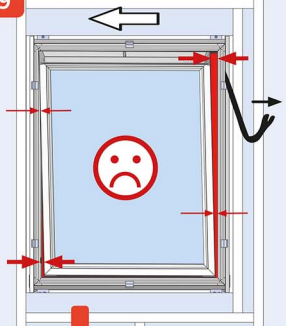

20

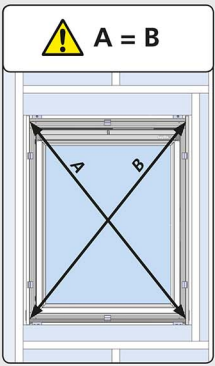

! A = B

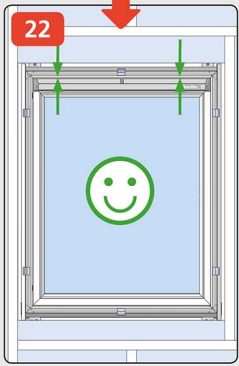

22

23

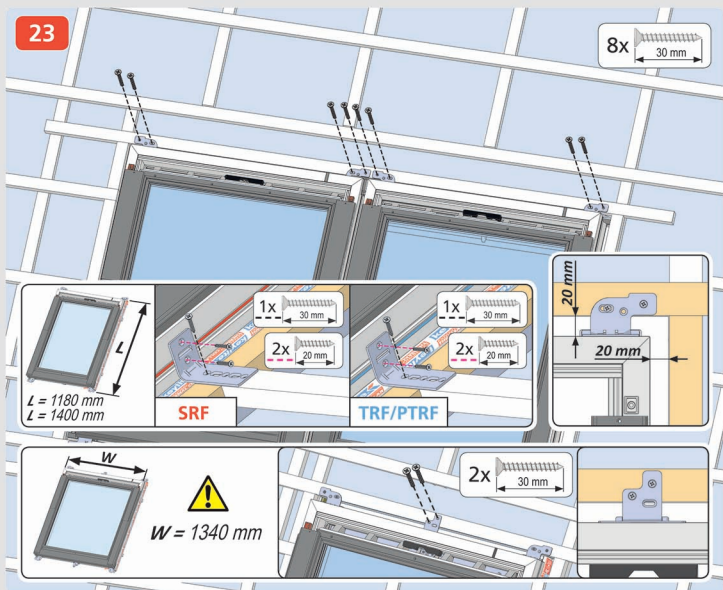
8x  30 mm

24

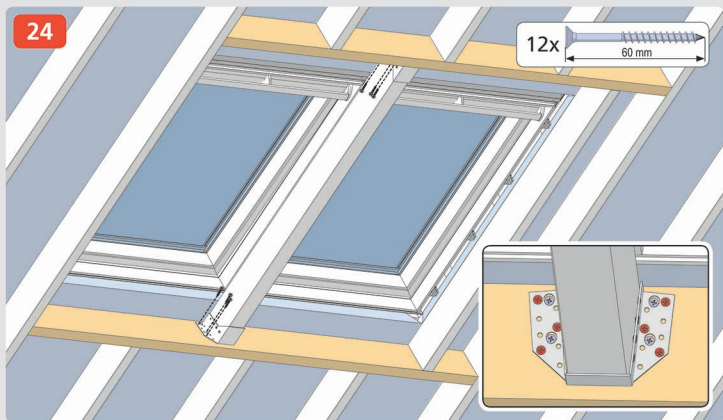
12x  60 mm

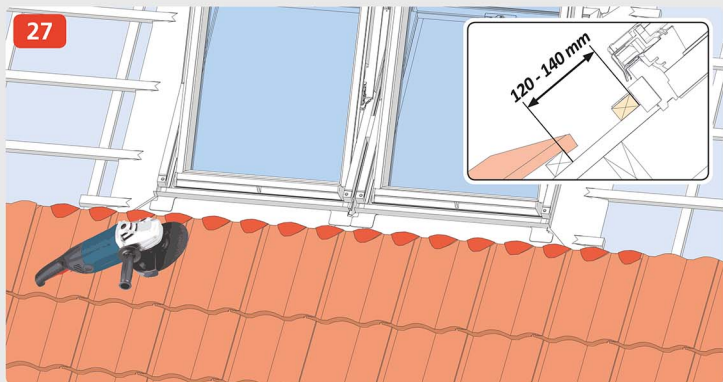
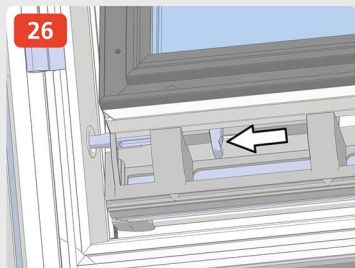
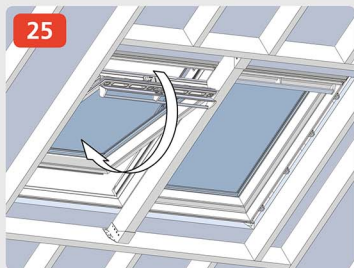
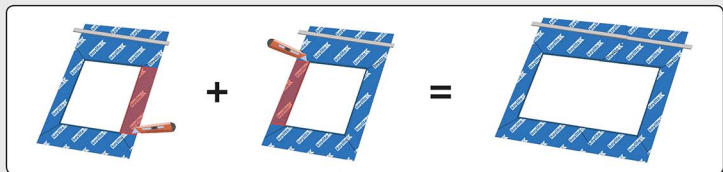

28

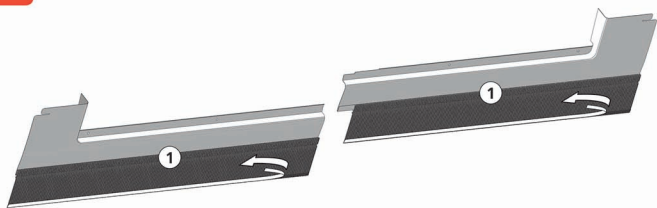

29

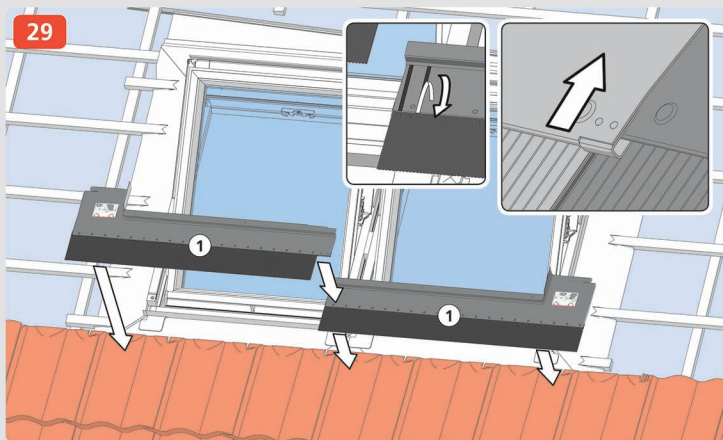

30

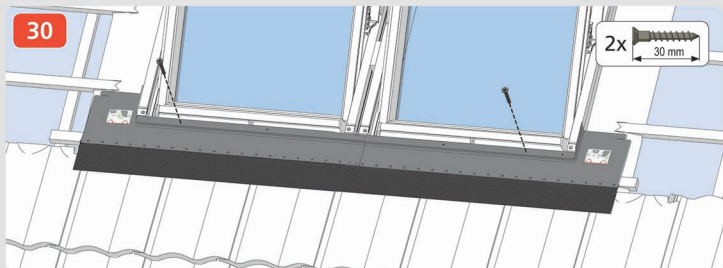

31

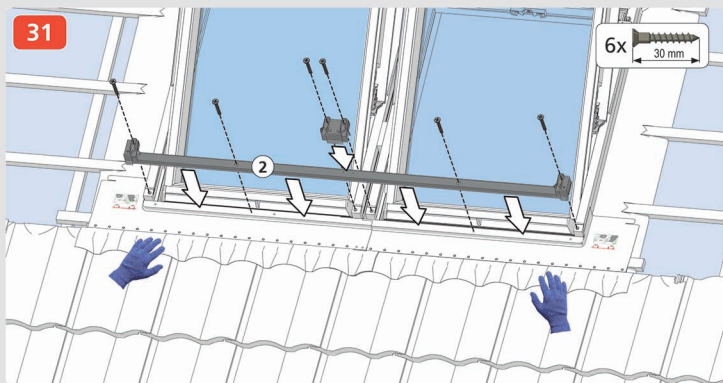

32

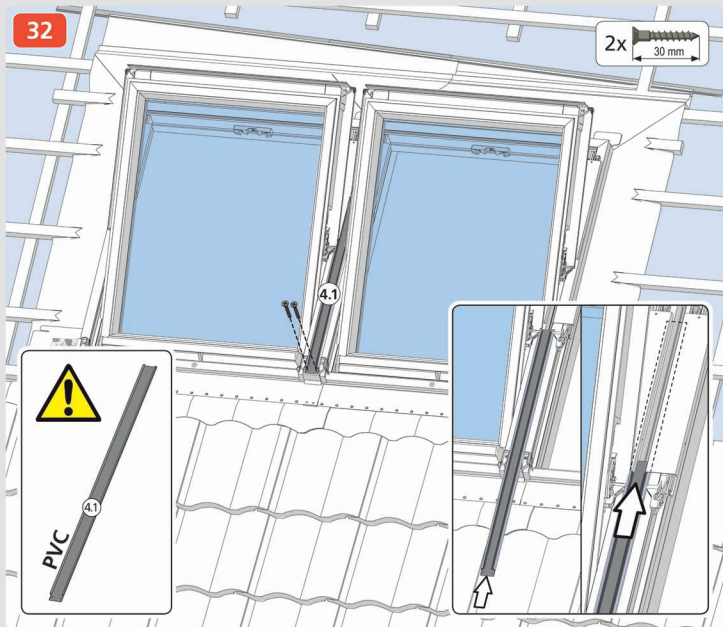

33

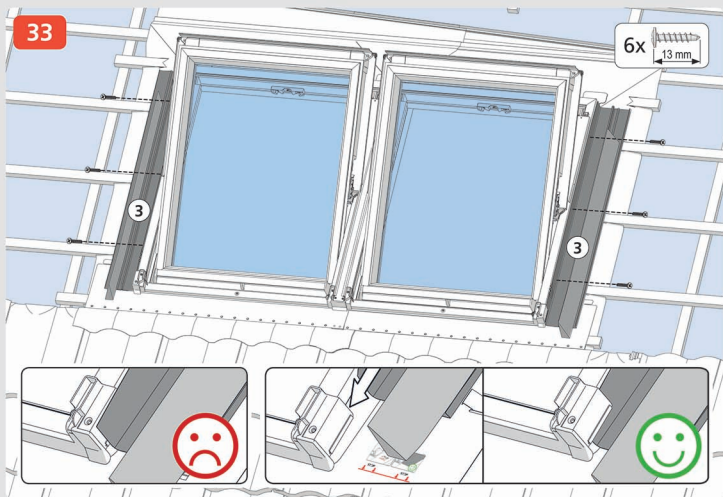

34

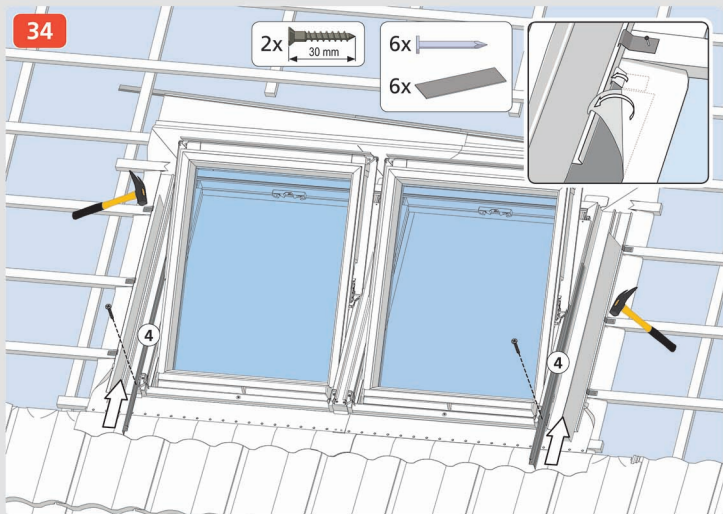

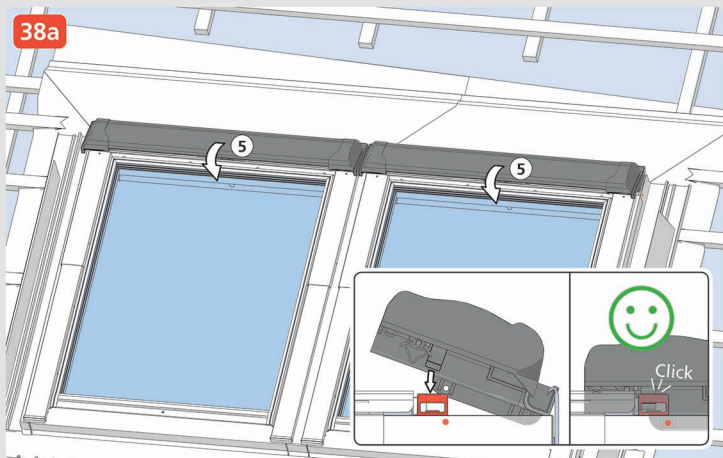
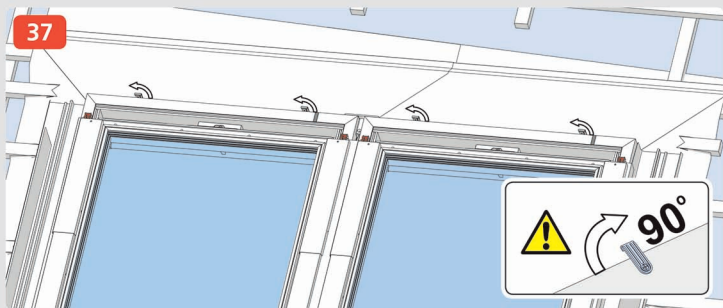
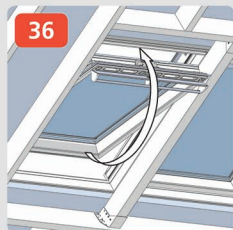
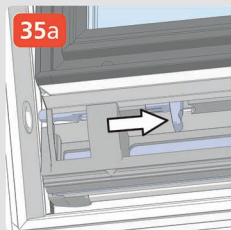

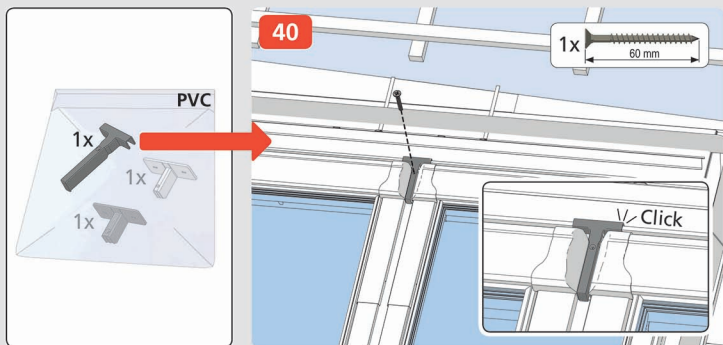
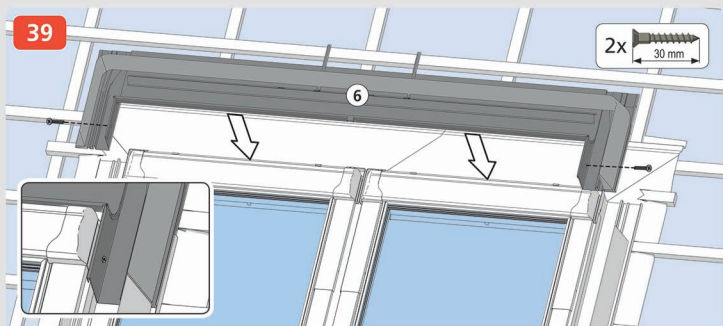
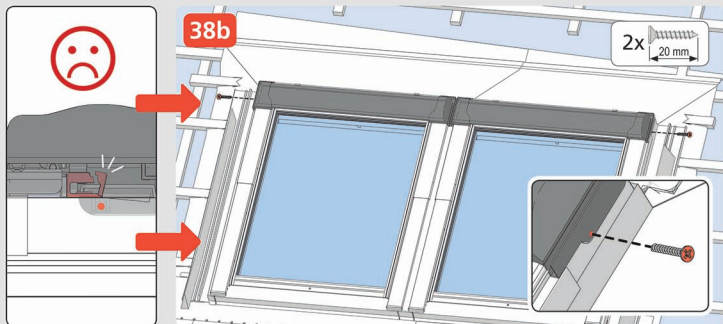

41

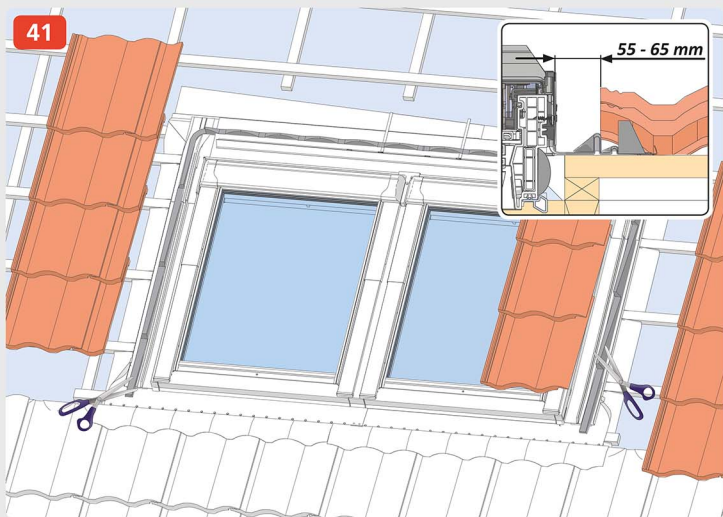

42



