

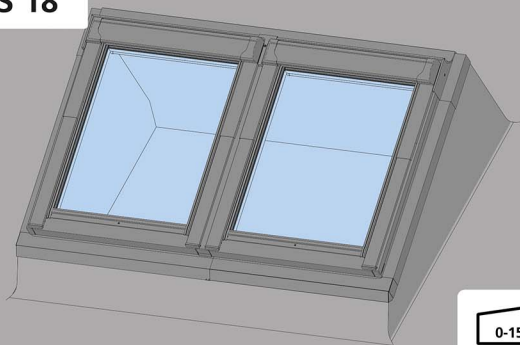

C FRS 18

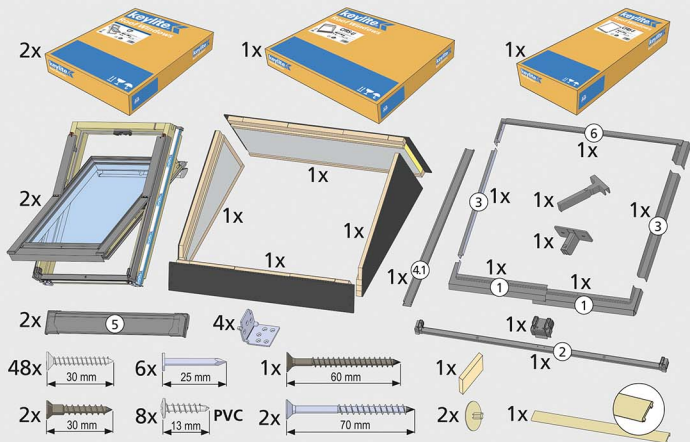

Combi Flat Roof System



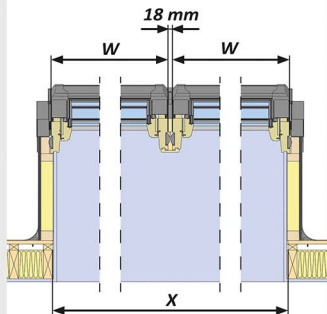
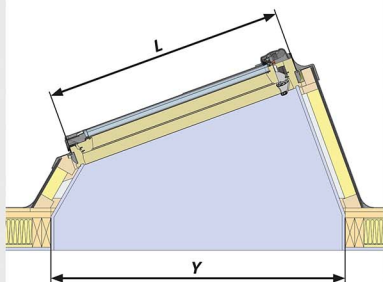

0-15°

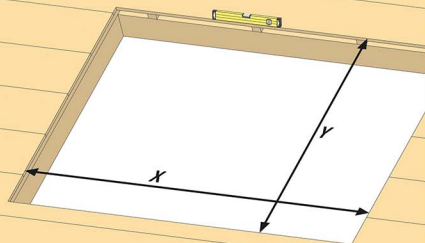

	W x L	X x Y
CFRS 01	550 x 780	1088 x 1000
CFRS 02	550 x 980	1088 x 1200
CFRS 01C	550 x 1180	1088 x 1400
CFRS 03	660 x 1180	1308 x 1400
CFRS 04	780 x 980	1548 x 1200
CFRS 05	780 x 1180	1548 x 1400
CFRS 06	780 x 1400	1548 x 1620
CFRS 07F	940 x 1400	1868 x 1620
CFRS 07	940 x 1600	1868 x 1820
CFRS 08	1140 x 1180	2268 x 1400
CFRS 09	1340 x 980	2668 x 1200
CFRS 10	1340 x 1400	2668 x 1620
CFRS ZZ	$X = 2 * W - 12 \text{ mm}$ $Y = L + 220 \text{ mm}$	

i

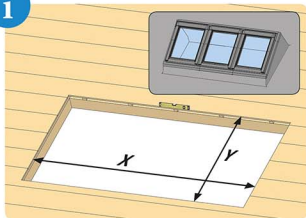

CFRS 3018

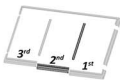

Window Size	W x L	X x Y
01	550 x 780	1650 x 1000
02	550 x 980	1650 x 1200
01C	550 x 1180	1650 x 1400
03	660 x 1180	1980 x 1400
04	780 x 980	2340 x 1200
05	780 x 1180	2340 x 1400
06	780 x 1400	2340 x 1620

1

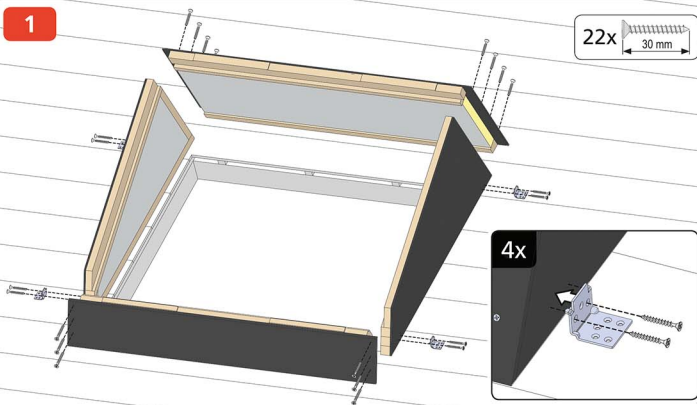

22x

30 mm

4x

2

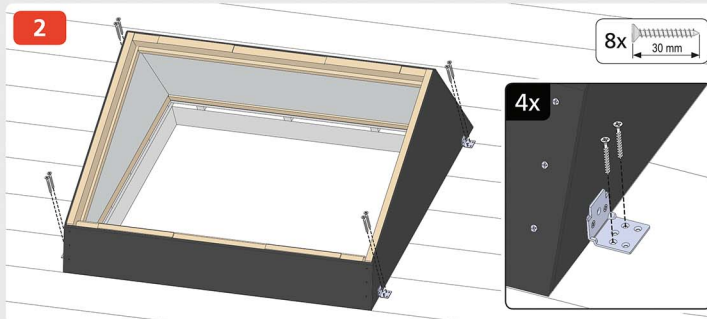

8x

30 mm

4x

3

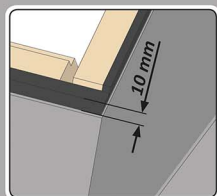
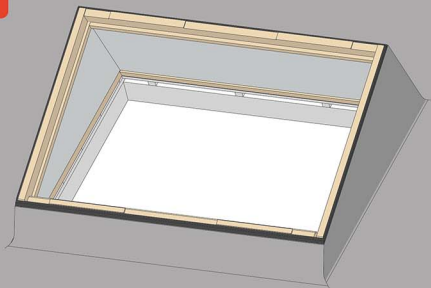

4a

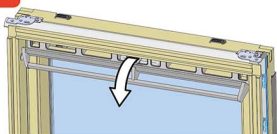

4b

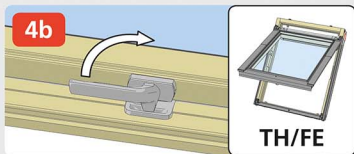

5

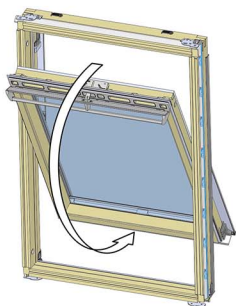

6

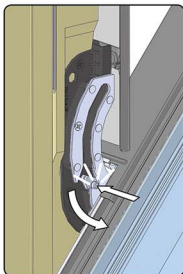

7

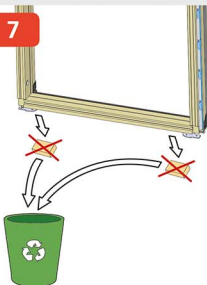

8

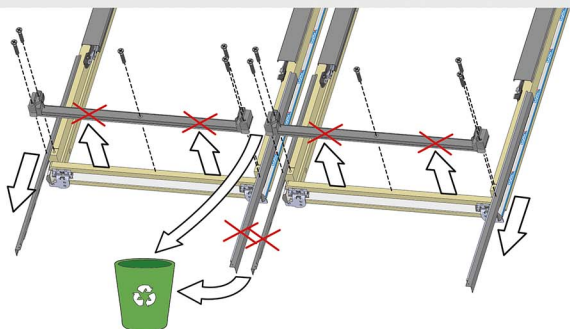

9

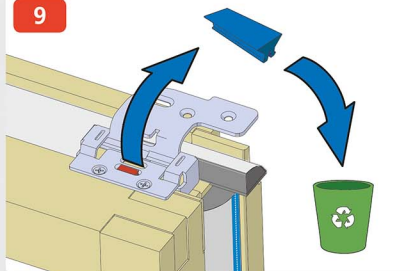

10

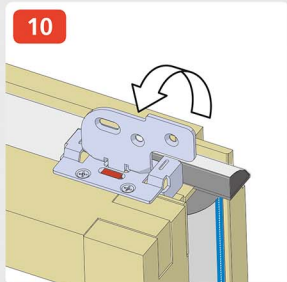

11

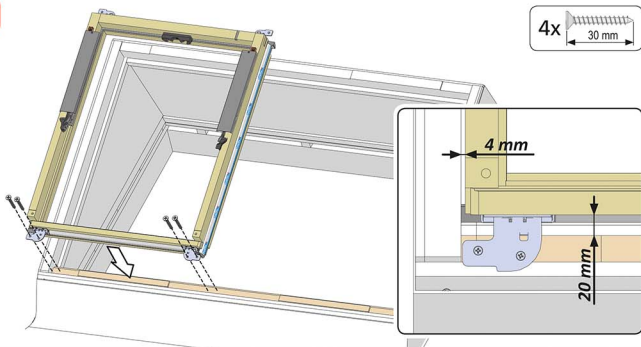

12

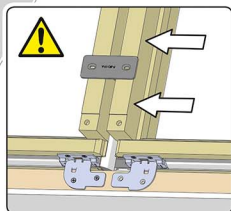
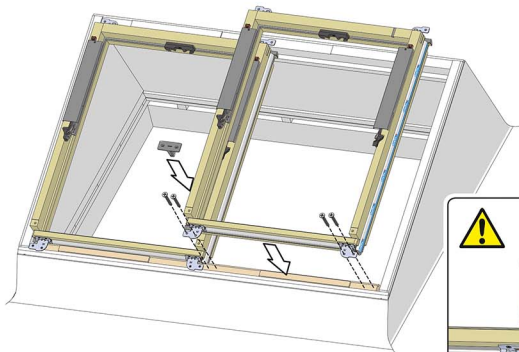
4x  30 mm

13

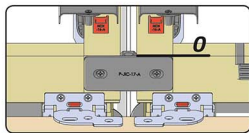
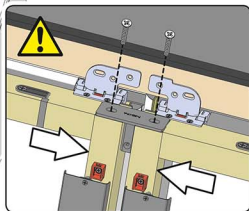
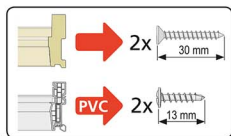
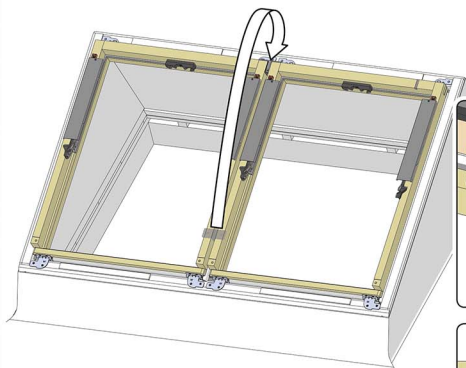

14

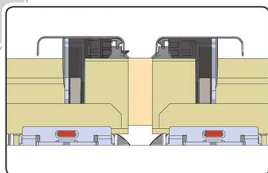
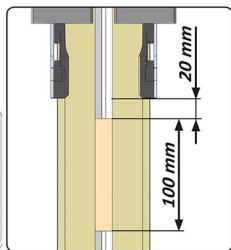
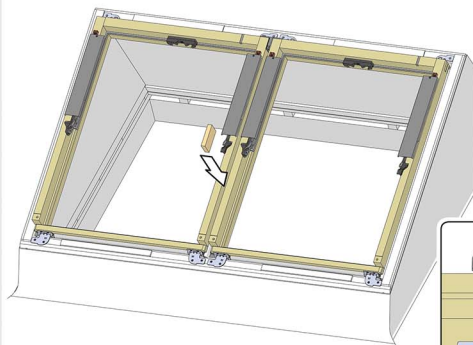

15

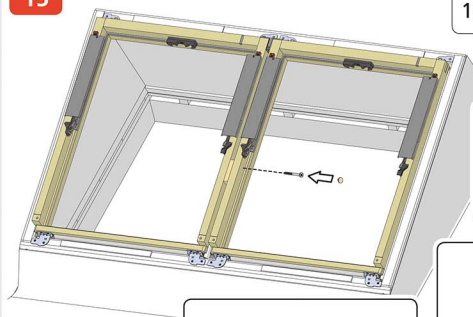

1x



1x

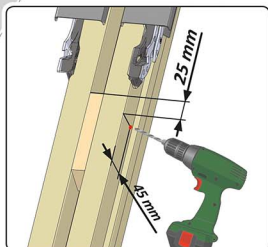
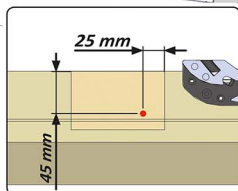
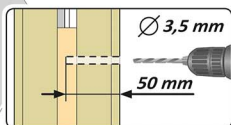
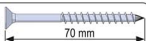

16

1x



1x

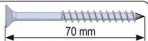

 $\varnothing 3,5 \text{ mm}$

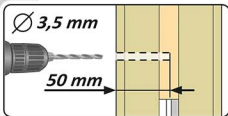
50 mm

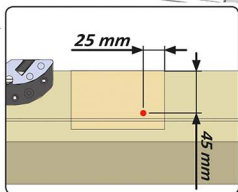

25 mm

45 mm



45 mm

25 mm

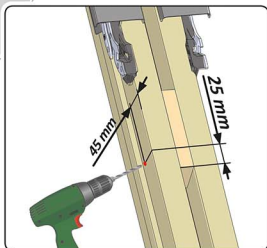

17

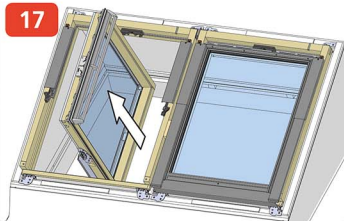

18

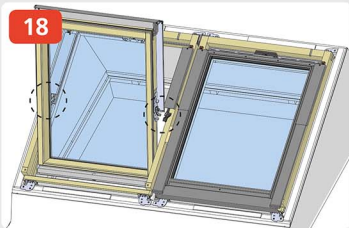

19

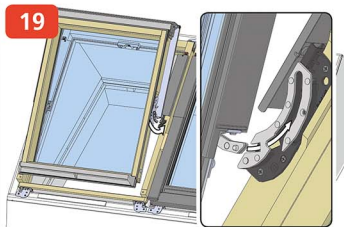

20

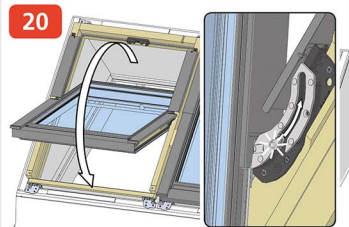

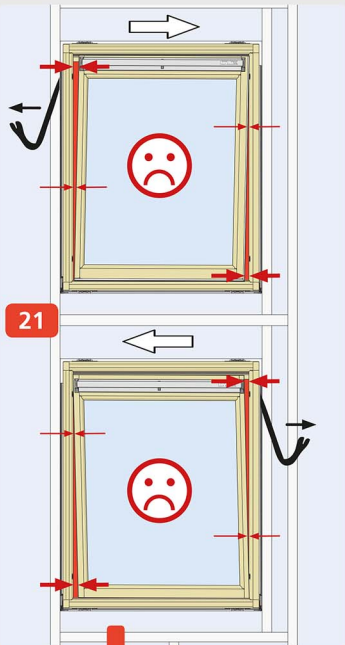

21

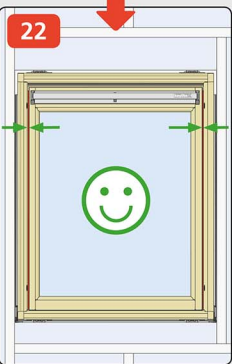

22

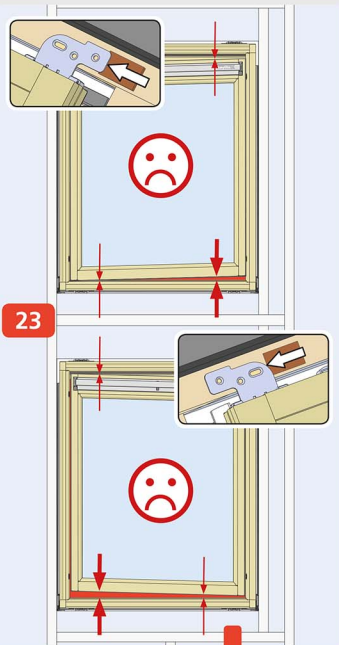

23

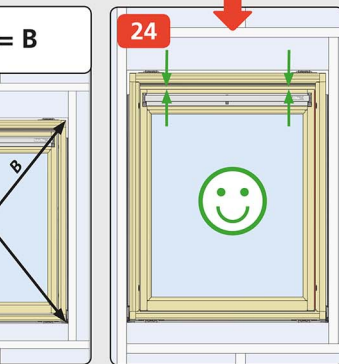

24

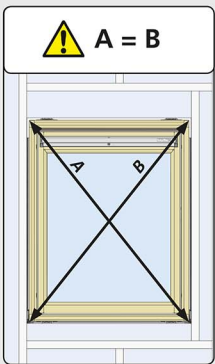

25

8x 30 mm

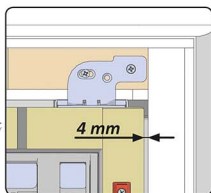
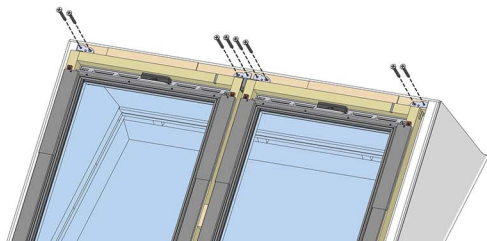

26

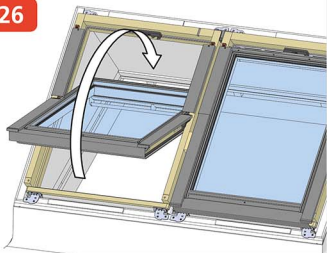

27

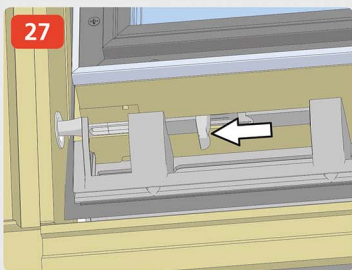

28

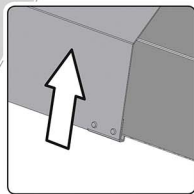
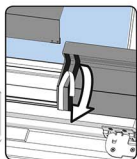
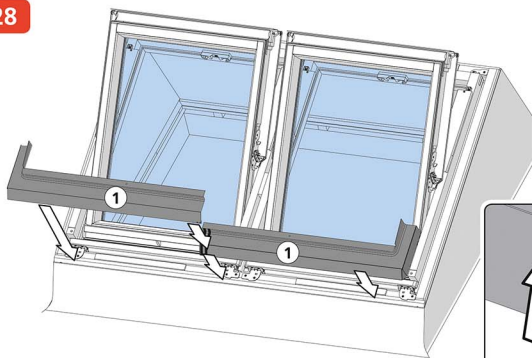

29

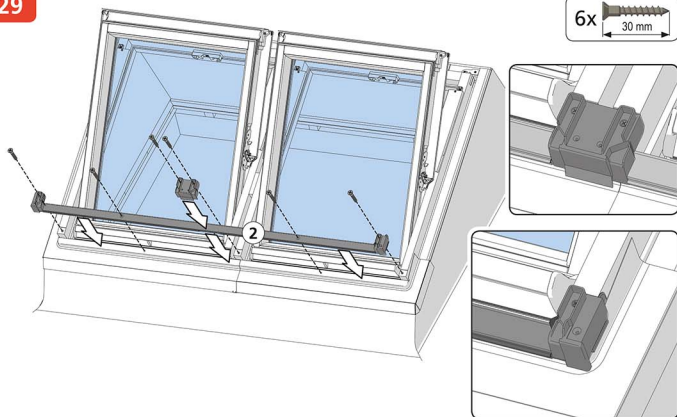

30

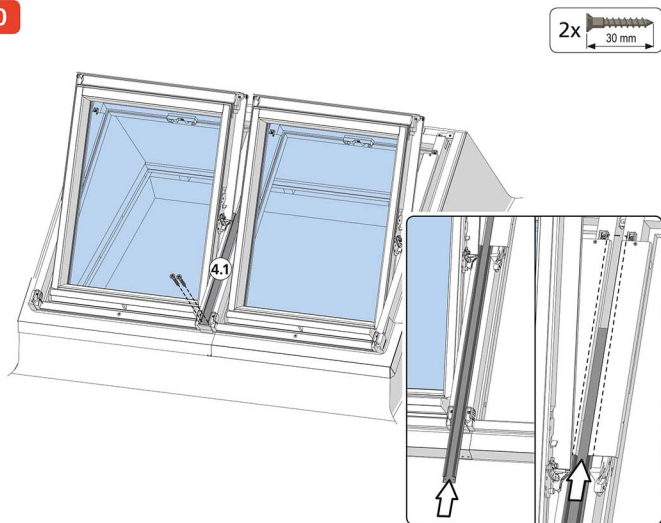

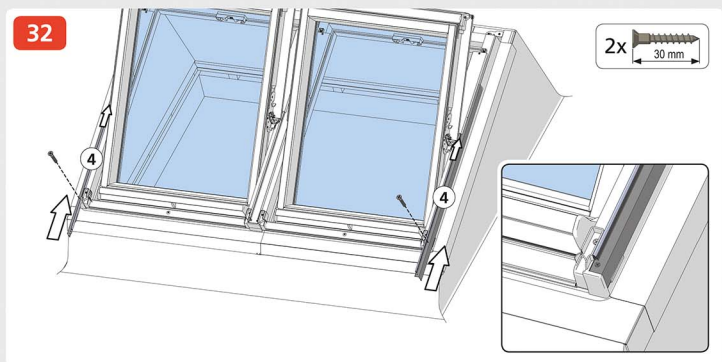
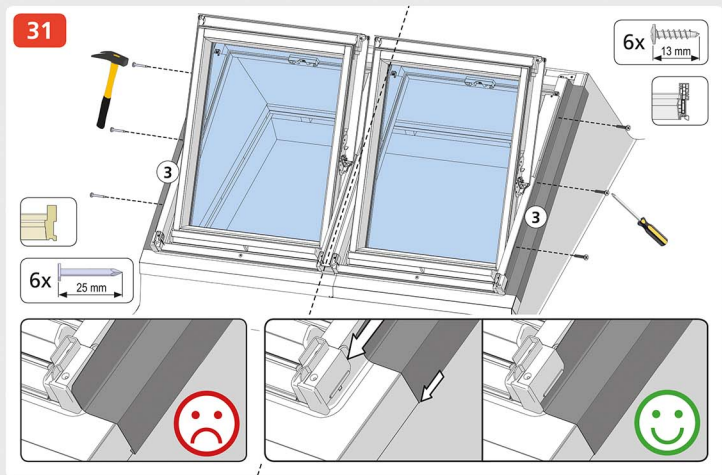
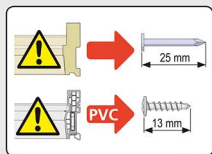

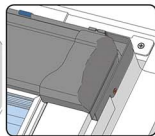
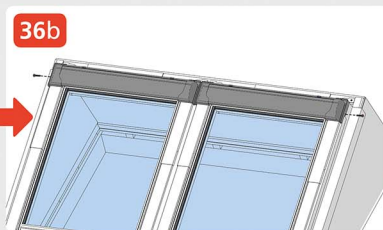
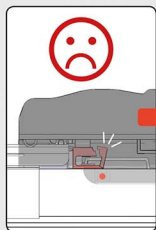
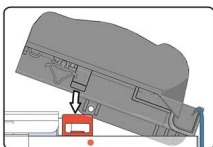
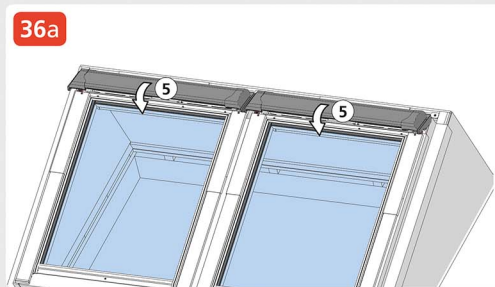
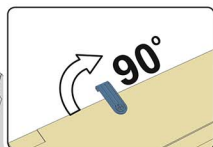
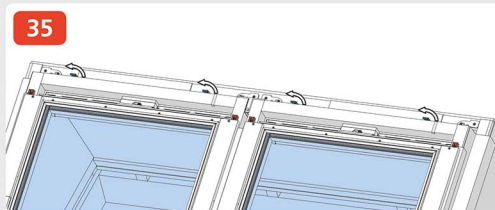
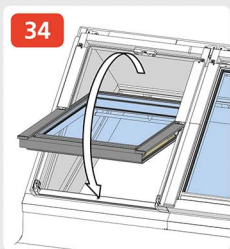
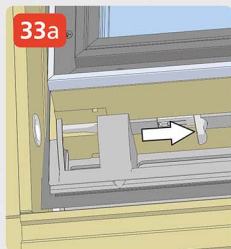

37

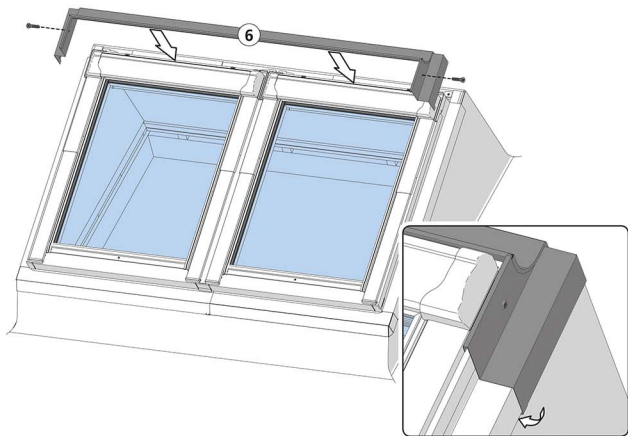

38

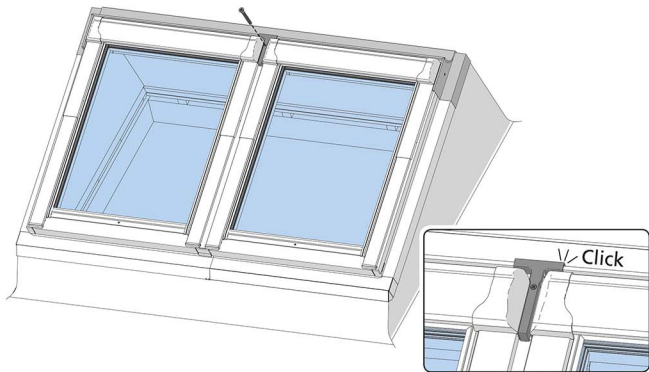
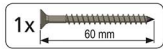

39

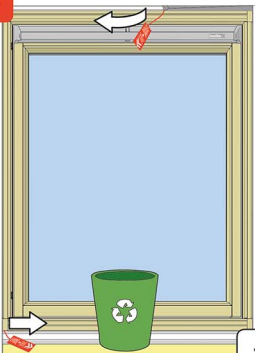

2x

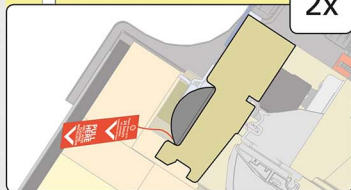

40

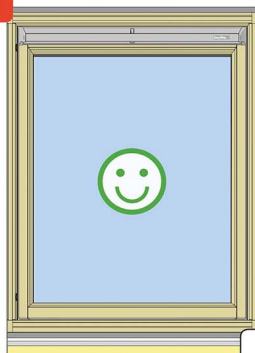

2x

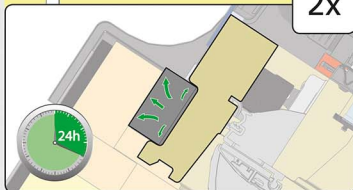

41

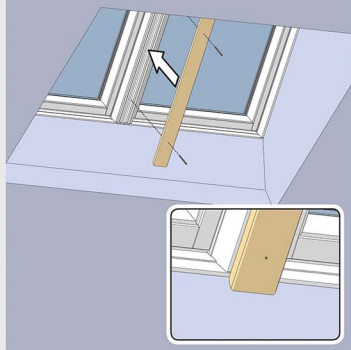

42

