



C FRX 18



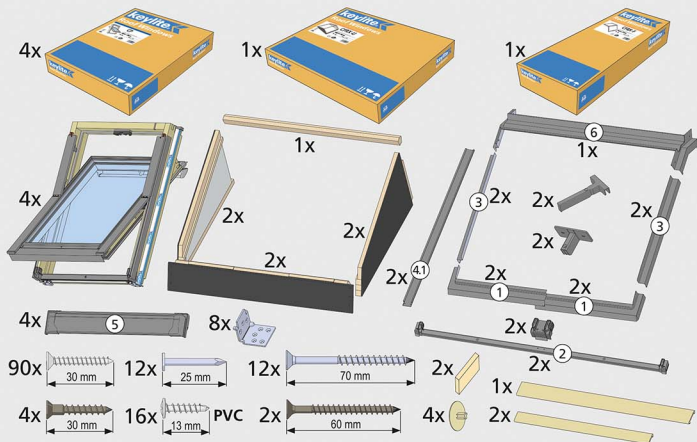

0-5°

Combi Flat Roof Apex System

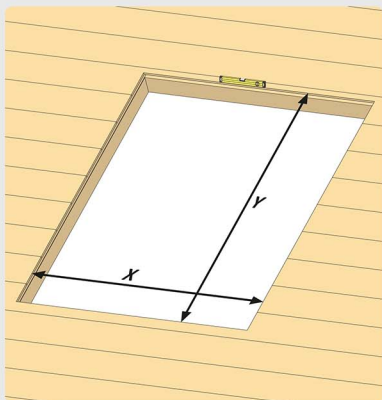
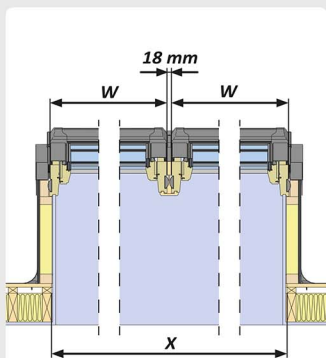
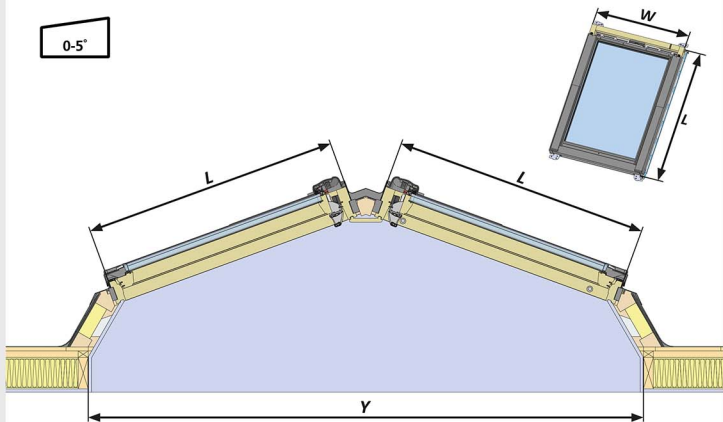

0-5°



$W \times L$	CFRX-01 550x780	CFRX-02 550x980	CFRX-01C 550x1180	CFRX-03 660x1180	CFRX-04 780x980	CFRX-05 780x1180	CFRX-06 780x1400	CFRX-07F 940x1400	CFRX-07 940x1600	CFRX-08 1140x1180
 $X \times Y$	1100x1740	1100x2115	1100x2490	1320x2490	1560x2115	1560x2490	1560x2900	1880x2900	1880x3280	2280x2490

i

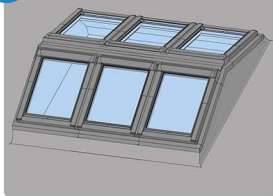

CFRX 3018

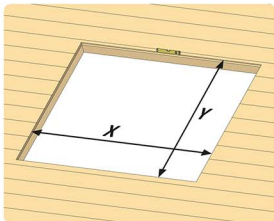
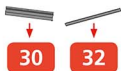
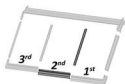

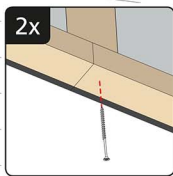
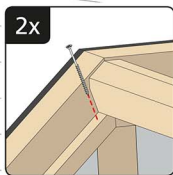
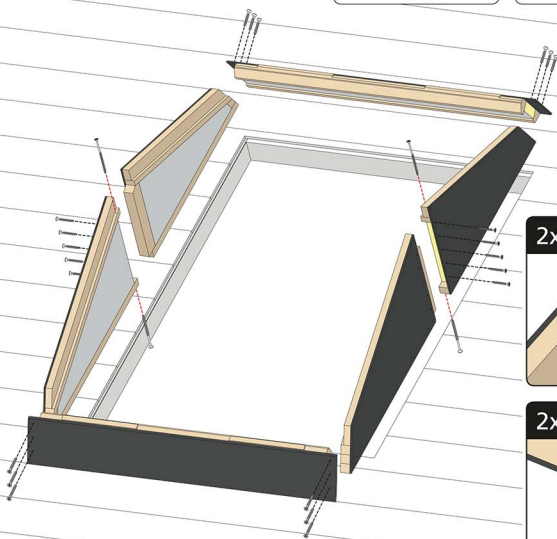
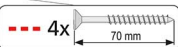
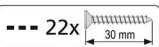

$W \times L$	CFRX-01 550 x 780	CFRX-02 550 x 980	CFRX-01C 550 x 1180	CFRX-03 660 x 1180	CFRX-04 780 x 980	CFRX-05 780 x 1180	CFRX-06 780 x 1400
$X \times Y$	1665 x 1740	1665 x 2115	1665 x 2490	1995 x 2490	2355 x 2115	2355 x 2490	2355 x 2900

1

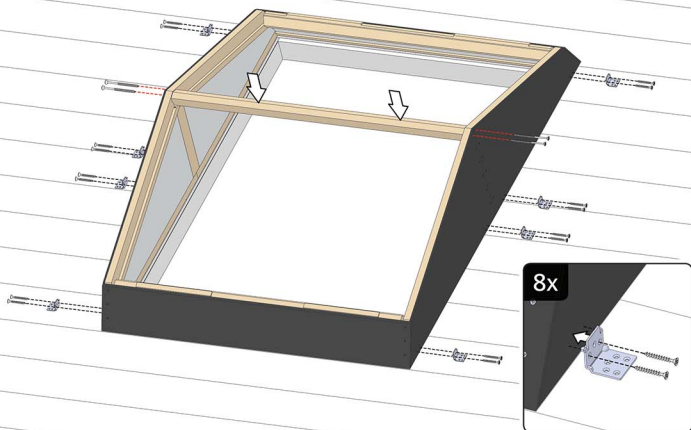

2

--- 16x  30 mm- - - 4x  70 mm

3

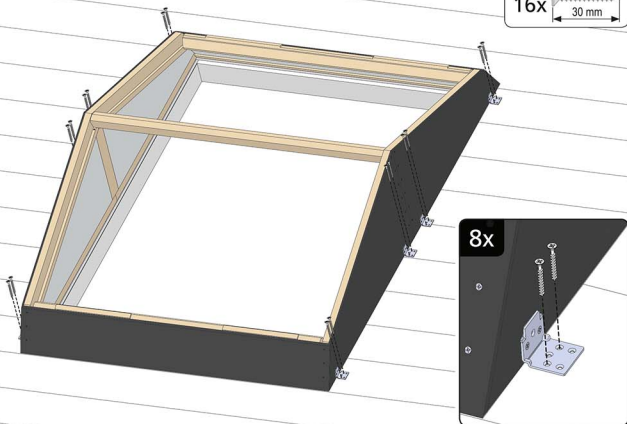
16x  30 mm

4

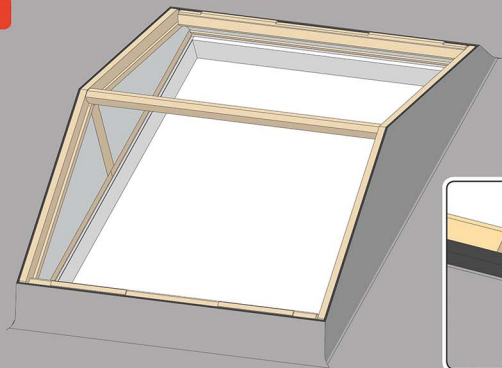

5a

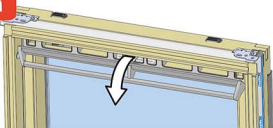

5b

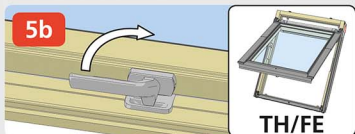

6

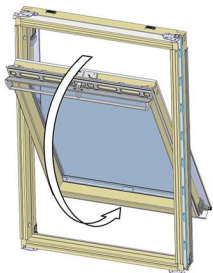

7

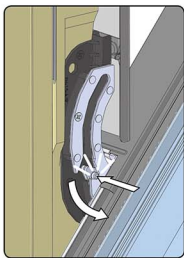

8

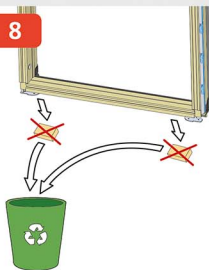

9

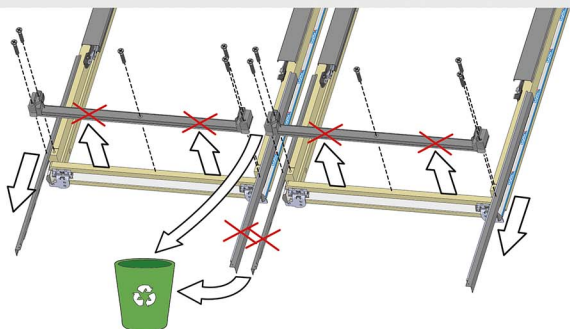

10

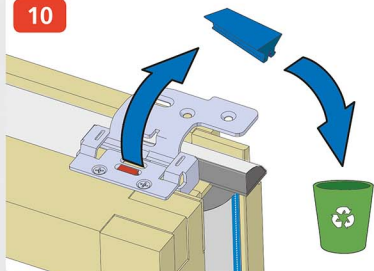

11

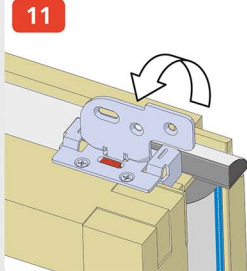

12

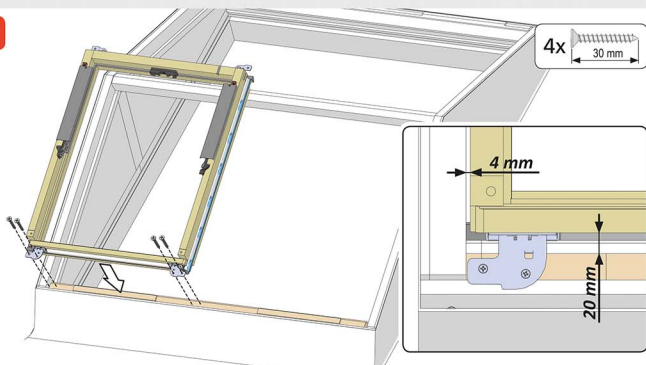

13

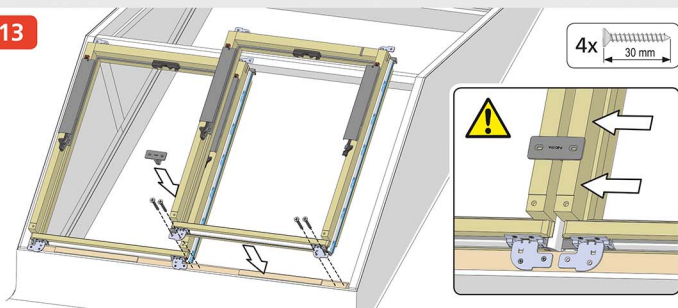

14

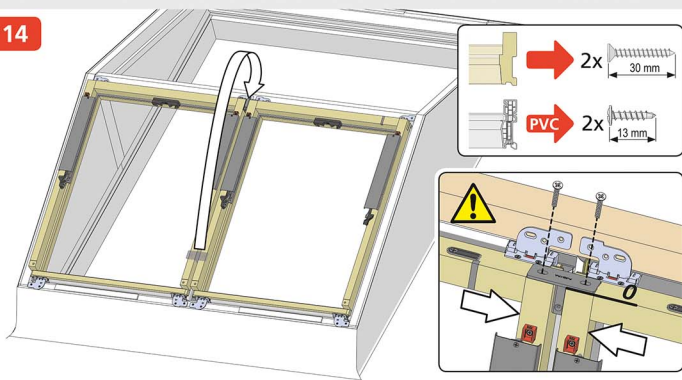

15

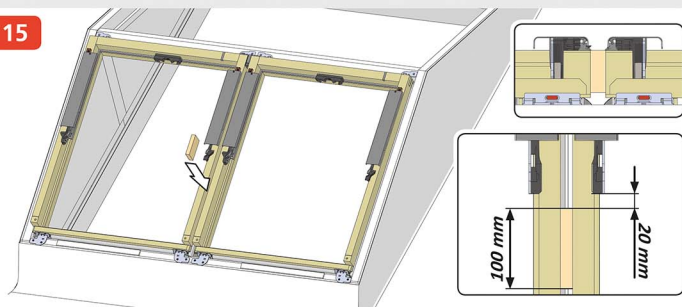

16

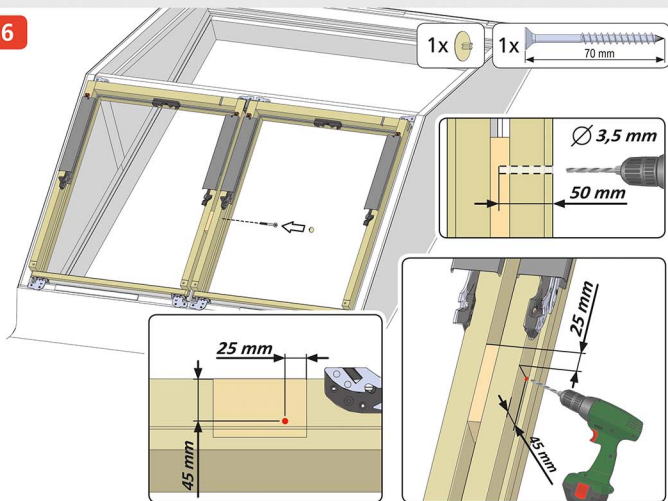

17

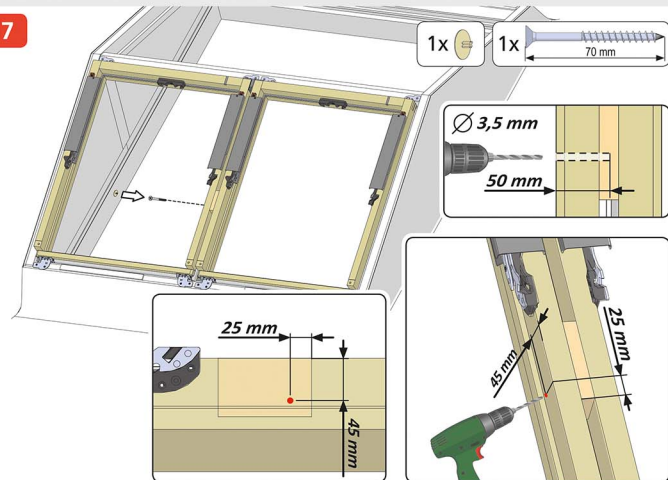

18

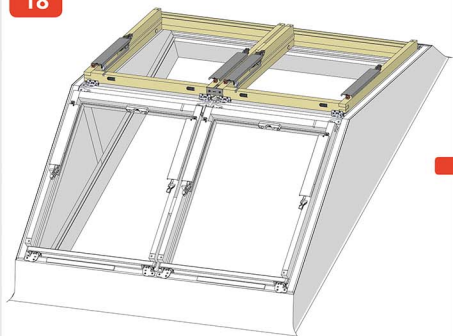

5



17



19

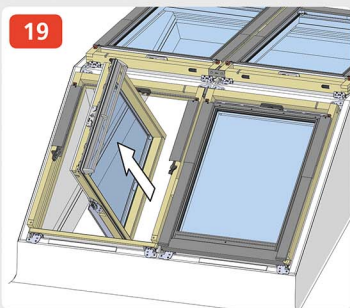

20

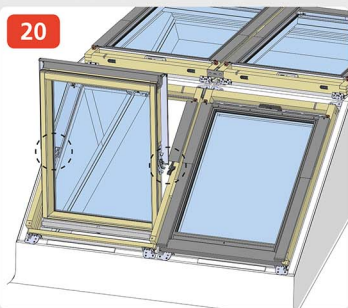

21

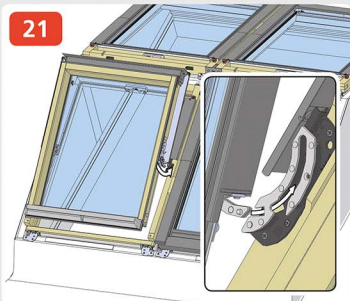

22

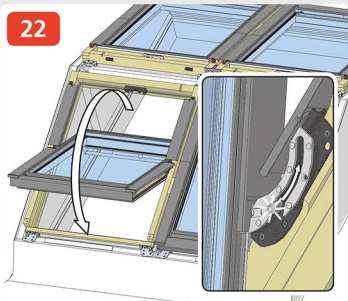

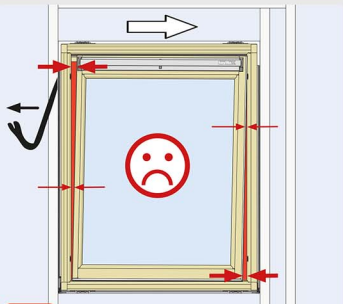

23

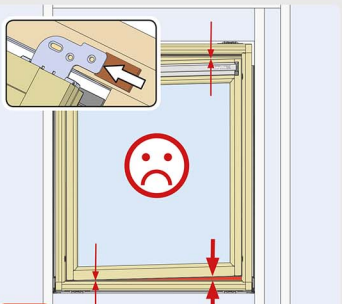

25

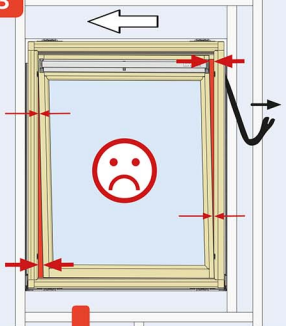

24

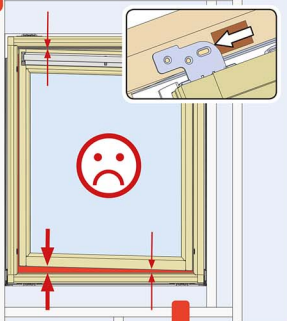

26

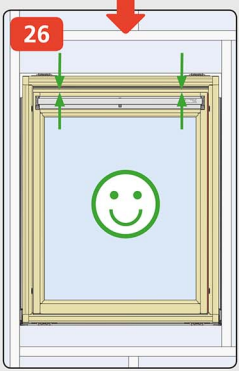
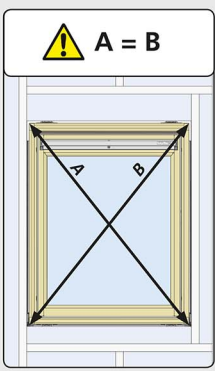
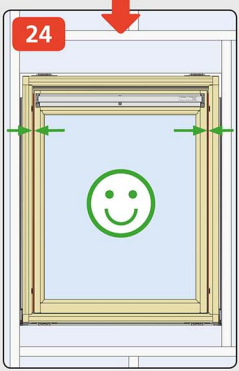

27

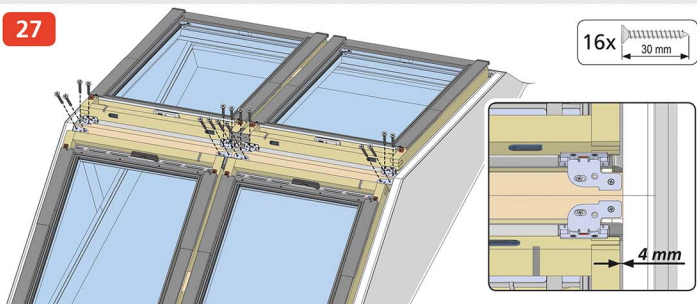

28

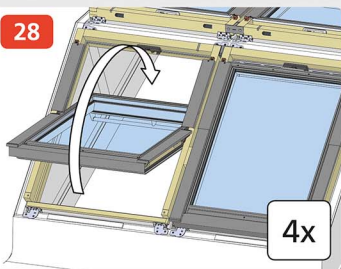

29

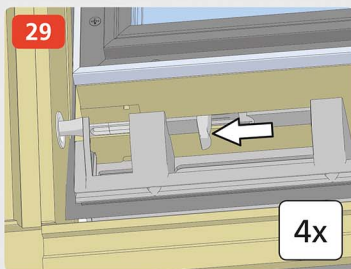

30

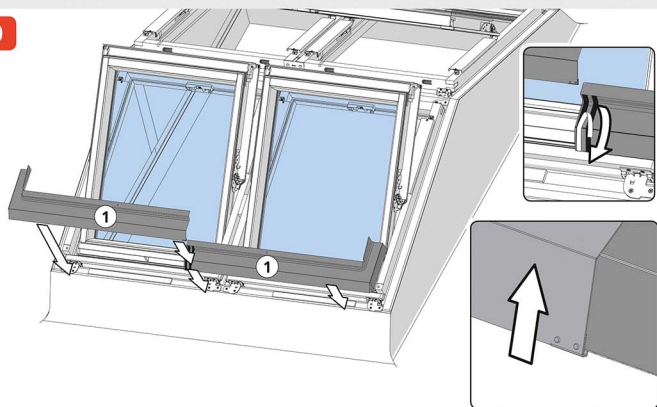

31

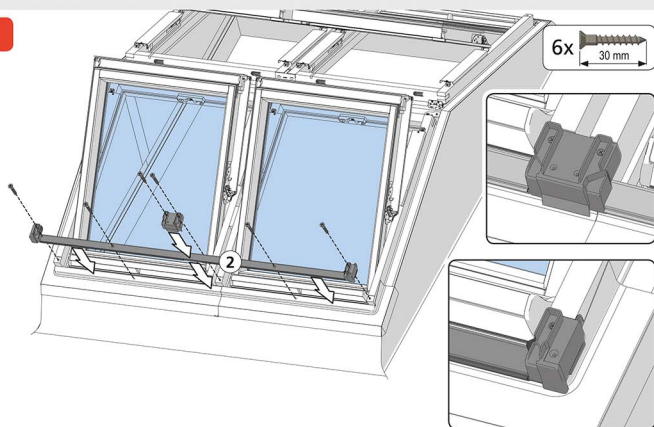

32

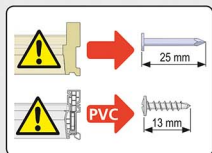
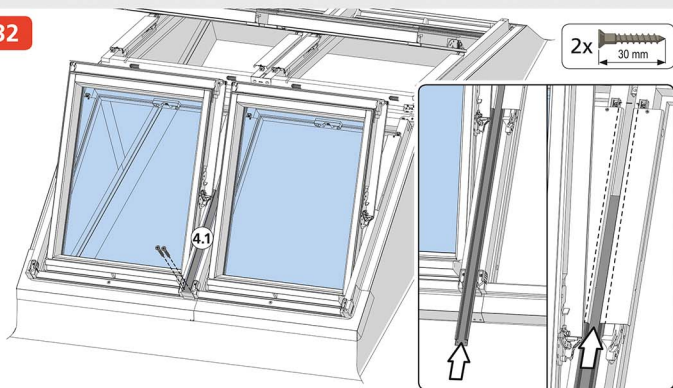

33

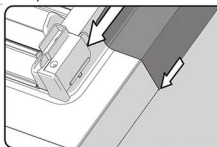
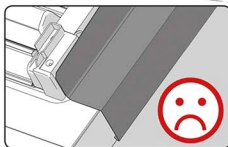
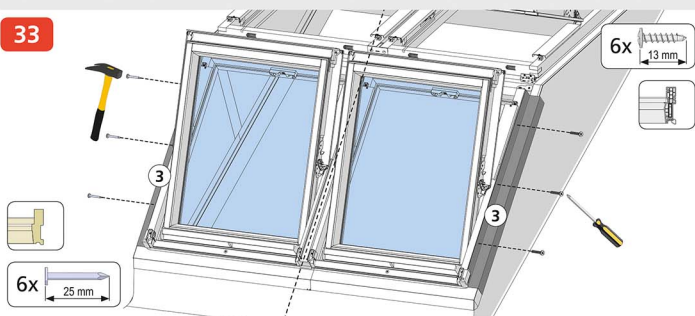

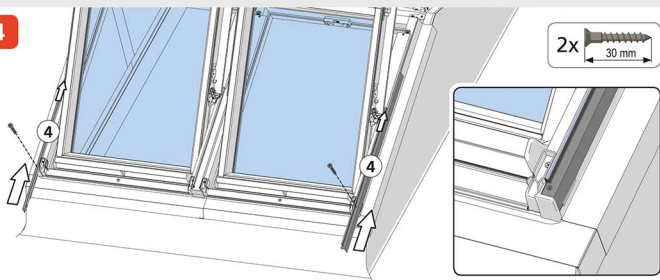

34

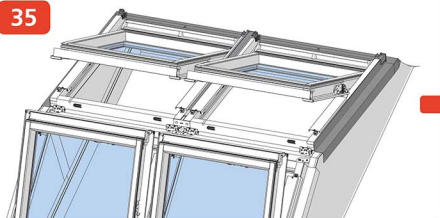

35



- 30  11
- ⋮
- 34  13

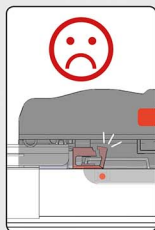
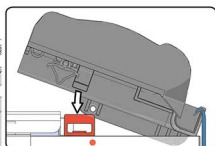
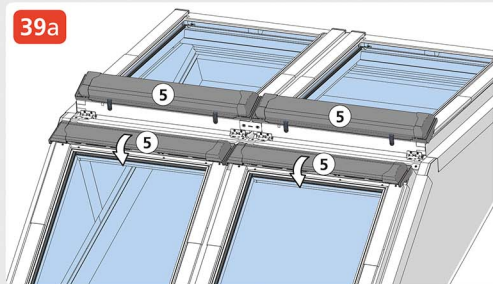
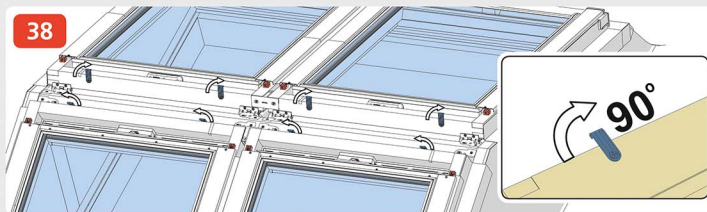
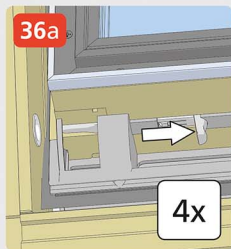

40

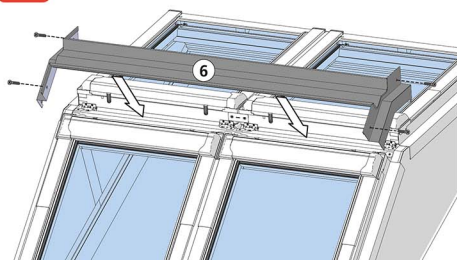

4x 30 mm

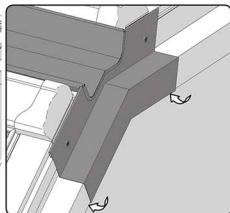

41

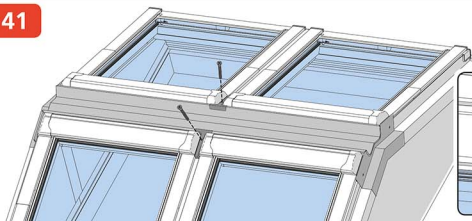

2x 60 mm

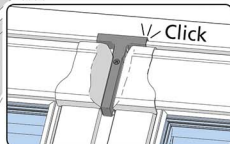

42



4x

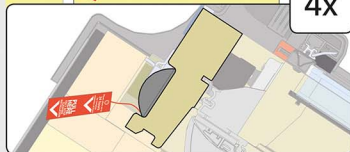

43



4x

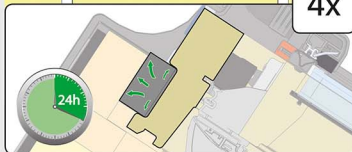

44

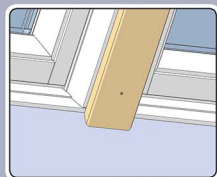
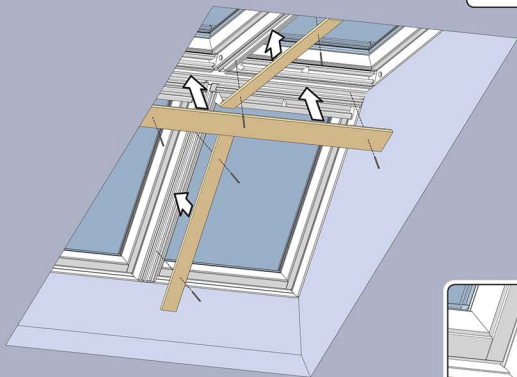

45

