

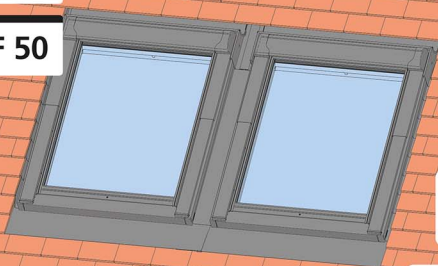

C PTRF 100

C PTRF 50



max 15 mm

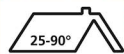

Combi System - Plain Tile Roof Flashing

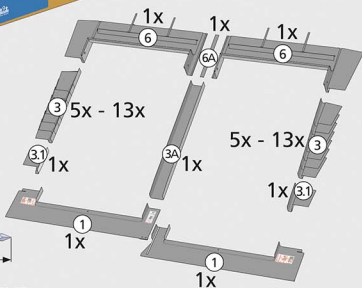
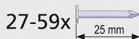
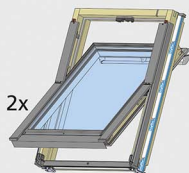
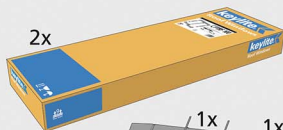

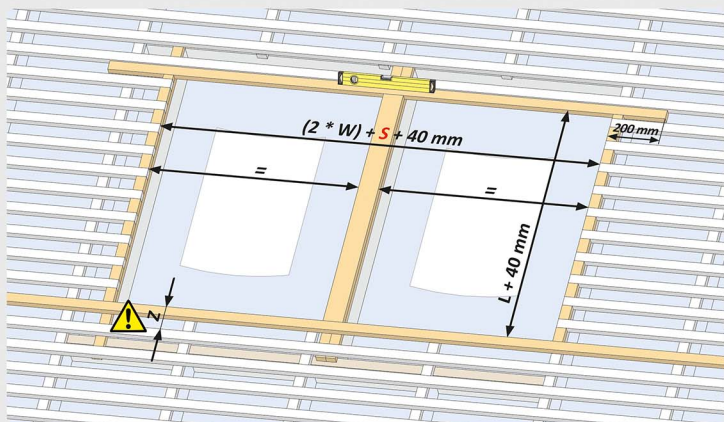
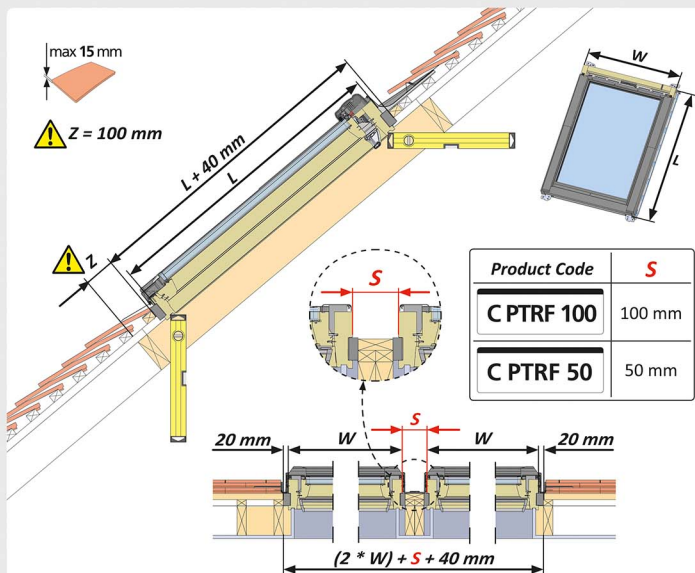

i

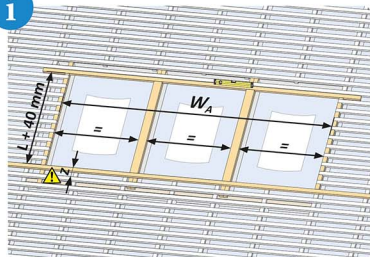

Q_{ty}	W_A
2	$(2 * W) + S + 40 \text{ mm}$
3	$(3 * W) + (2 * S) + 40 \text{ mm}$
X	$(X * W) + ((X - 1) * S) + 40 \text{ mm}$

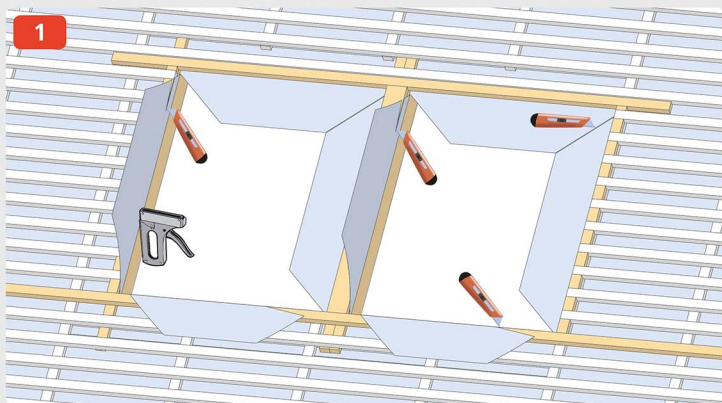
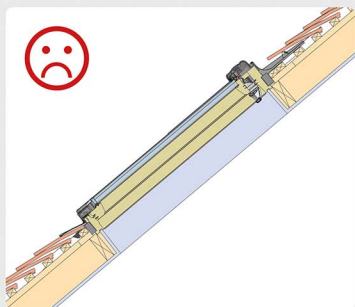
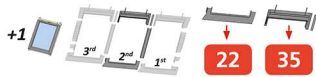

2a

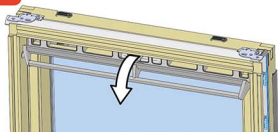

2b

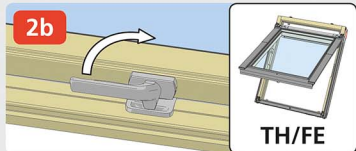

3

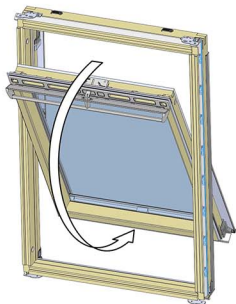

4

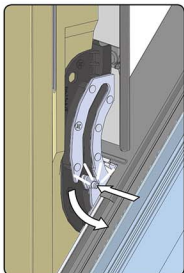

5

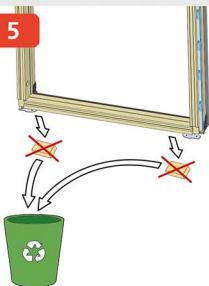

6

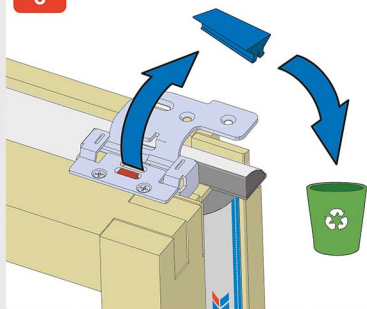

7

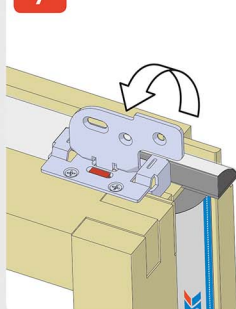

8

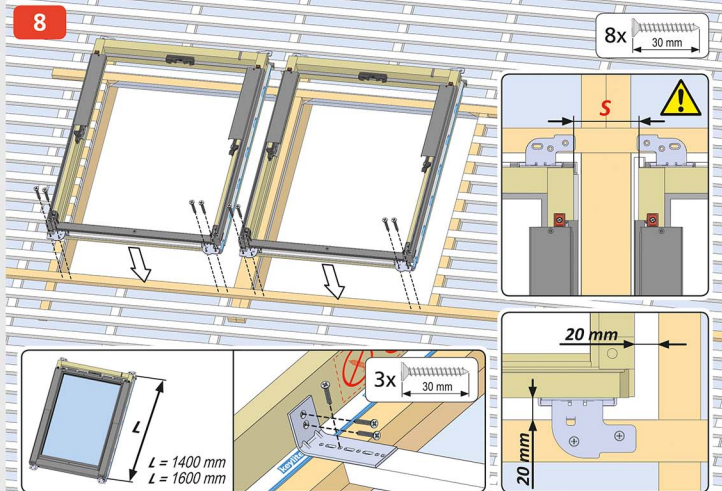

9

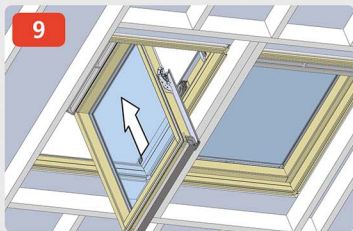

10

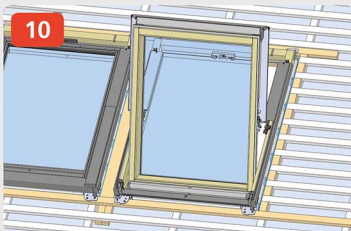

11

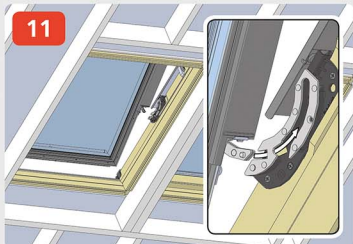

12

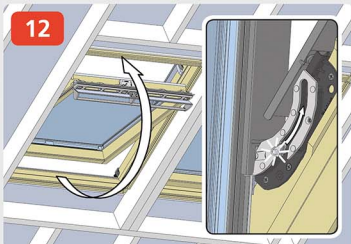

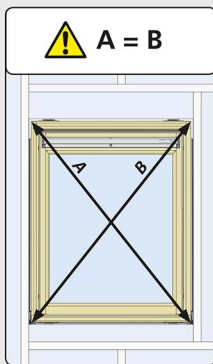
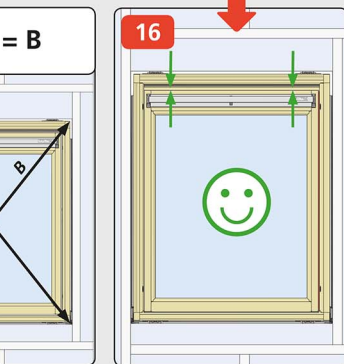
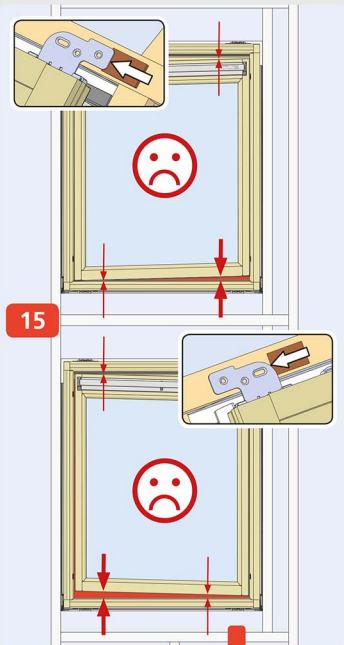
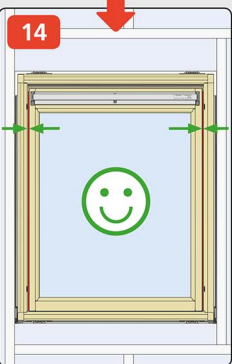
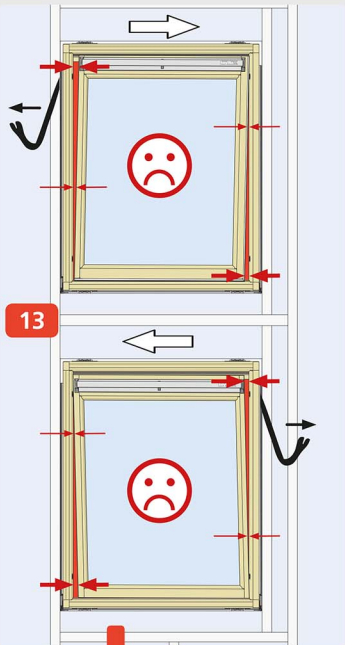

17

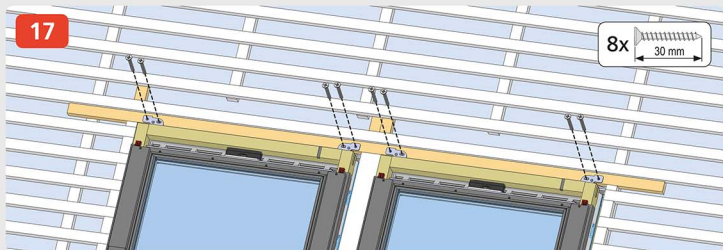
8x  30 mm

2x



18

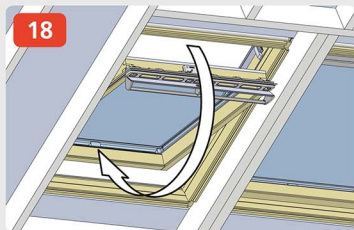

19

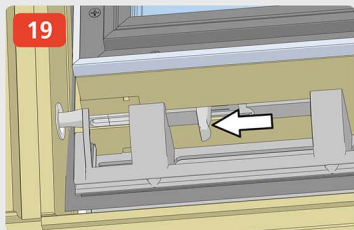

20

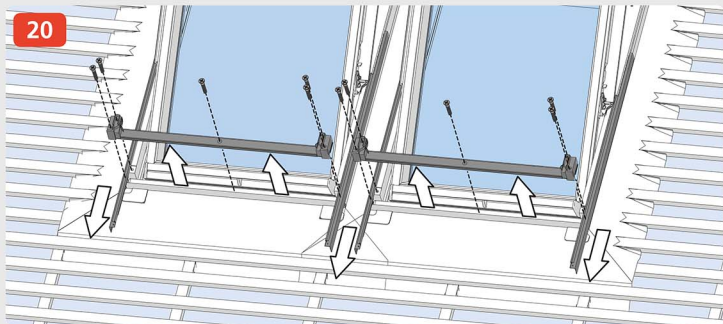

21

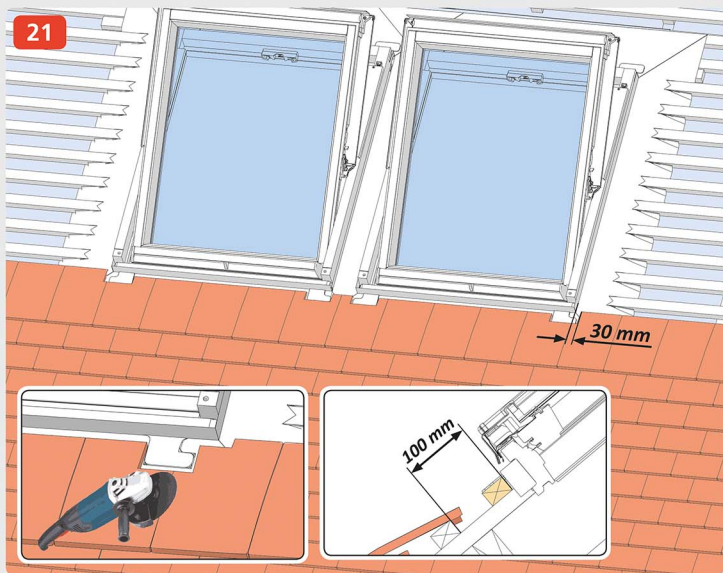

22

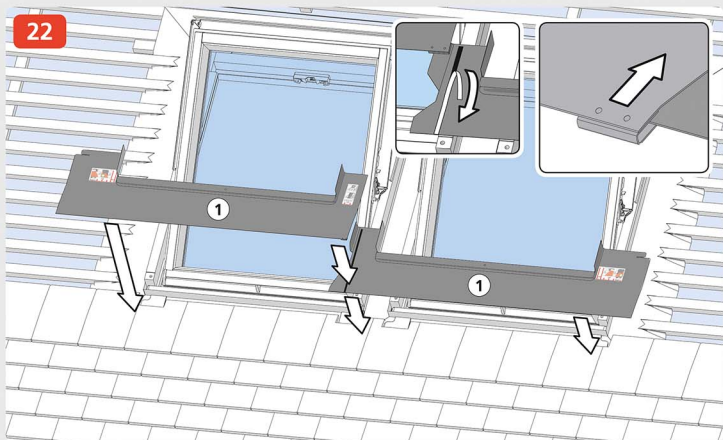

23

6x 30 mm

2

2

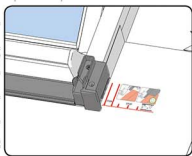

24

3A

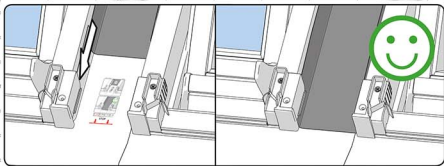

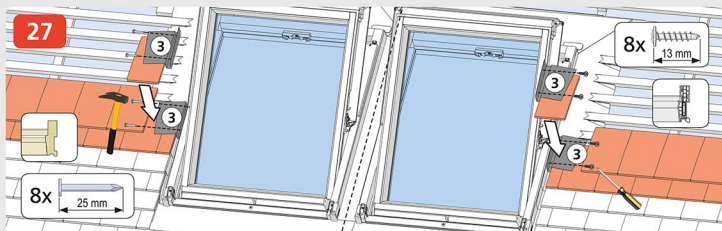
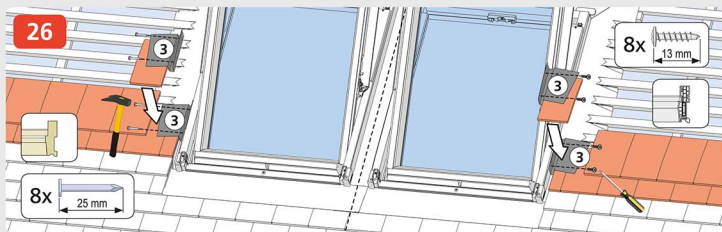
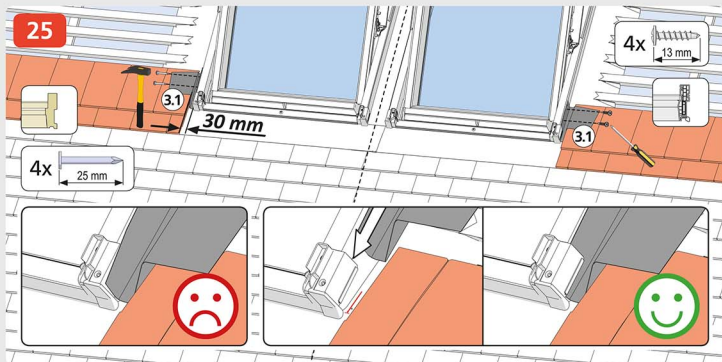
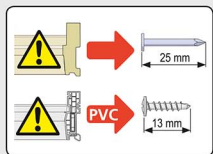

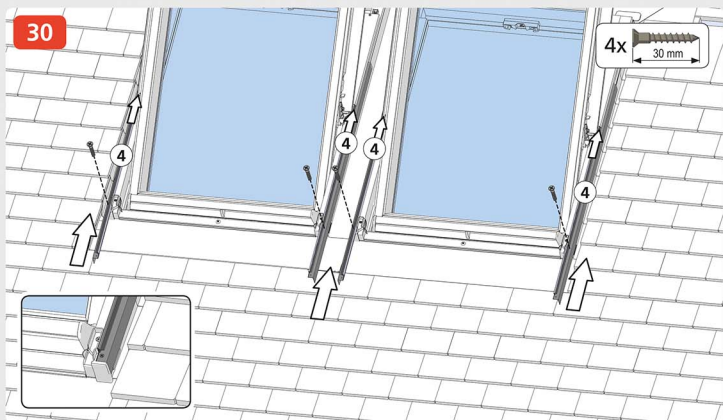
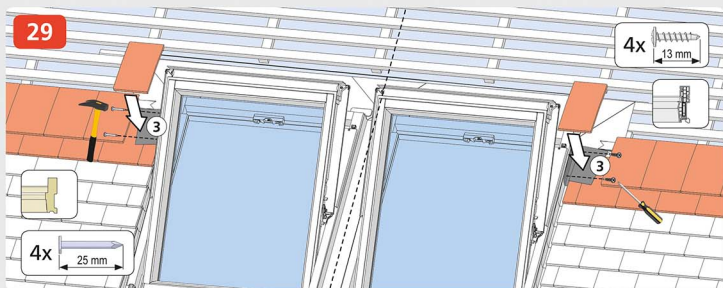
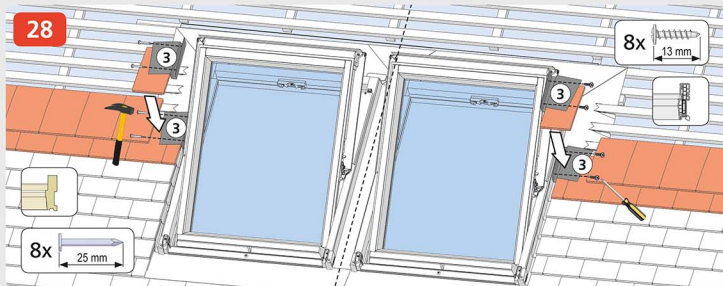

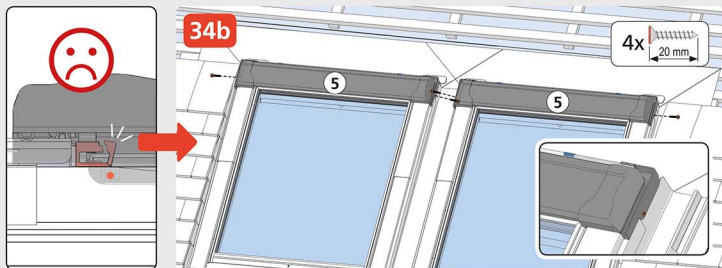
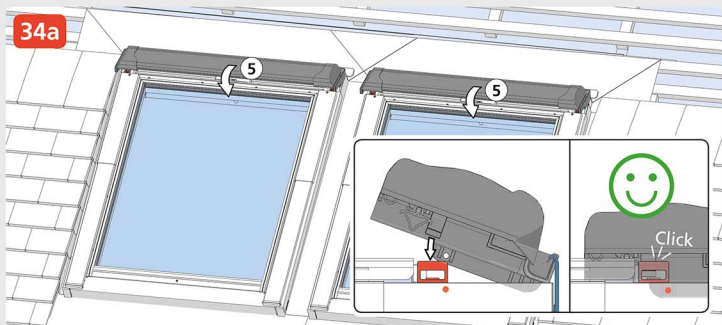
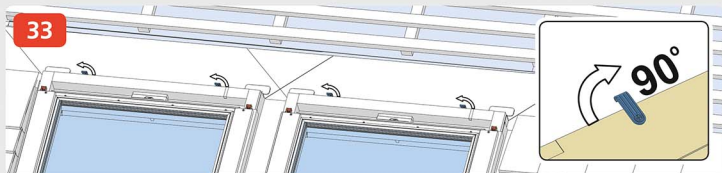
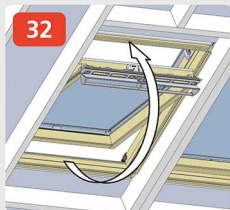
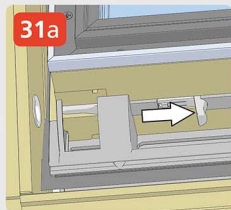



C PTRF 100

S = 100 mm

35a

4x  30 mm

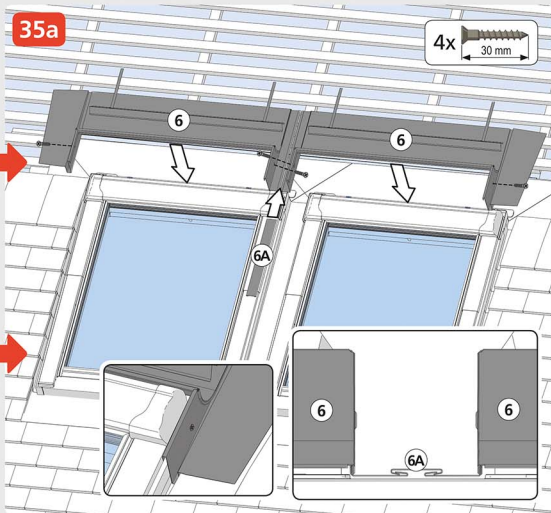

C PTRF 50

S = 50 mm

35b

4x  30 mm

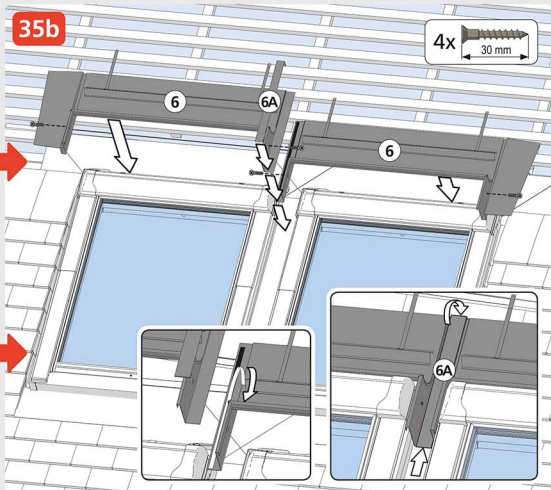

36

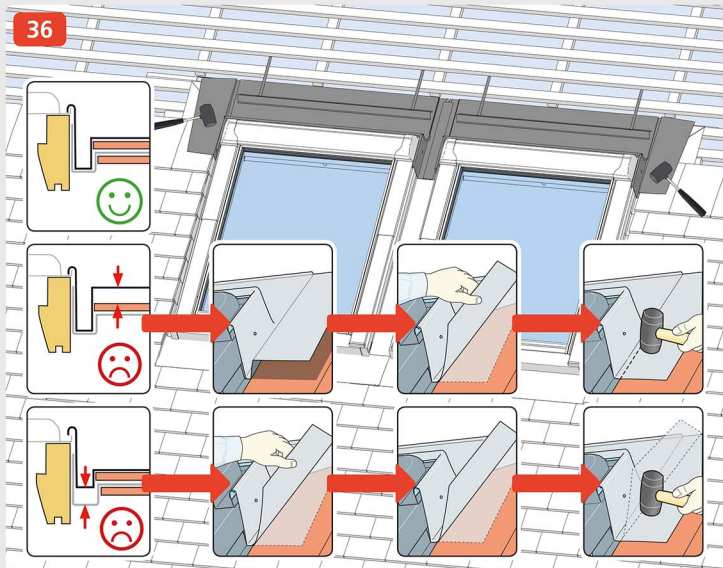

37



