

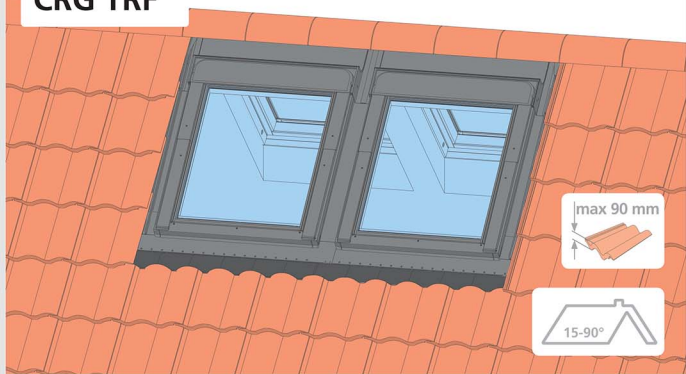

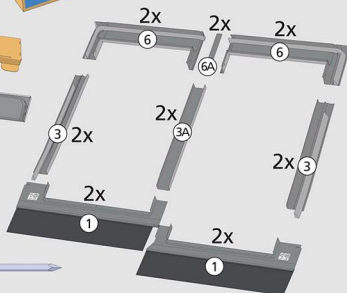

CRG TRF

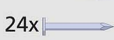
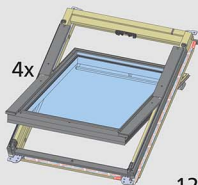

Futuretherm Technology™

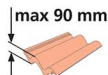



 $Z = 120 - 140 \text{ mm}$

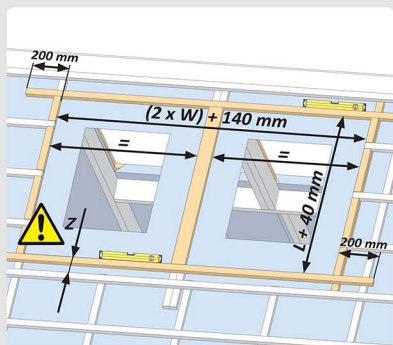
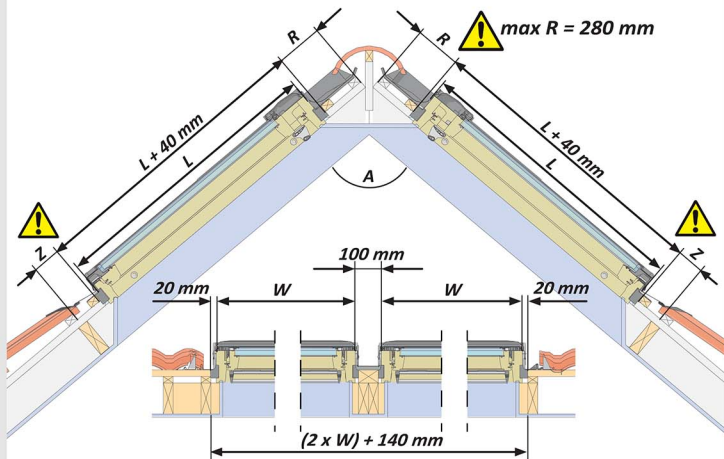
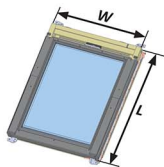

		<i>minimum R</i>				
A	L	780	980	1180	1400	1600
140°	80	80	80	80	80	80
130°	80	80	80	80	80	80
120°	80	80	80	80	80	80
110°	80	80	80	80	80	100
100°	80	80	80	120	140	
90°	80	80	120	180	200	
80°	80	120	180	260		
70°	100	180	260			
60°	140	260				

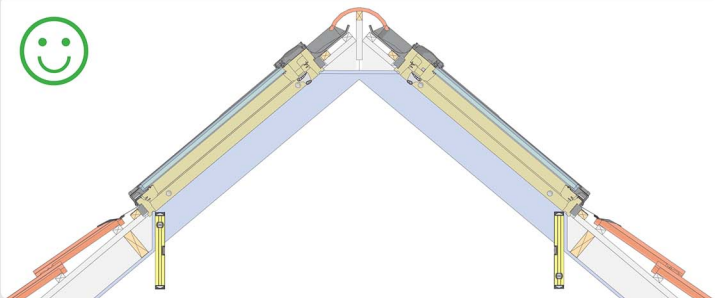
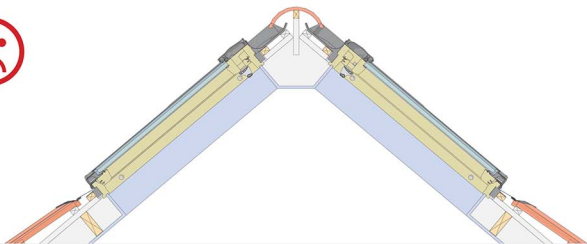

1

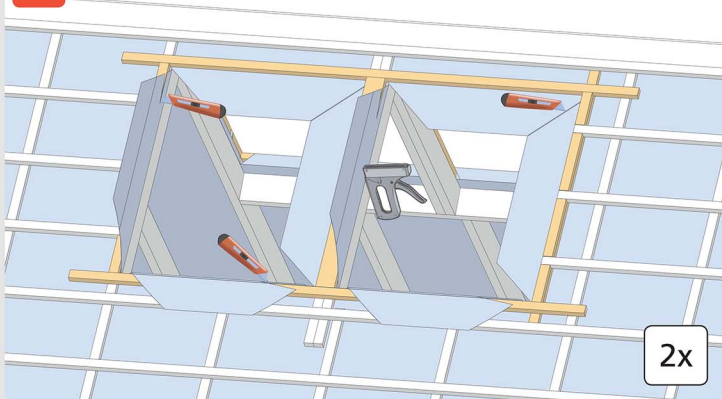

2x

2a

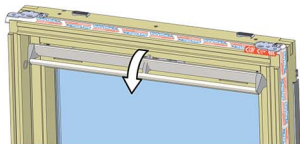

3

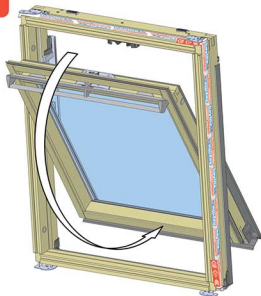

2b

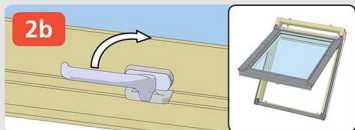

4

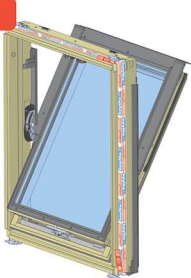

5

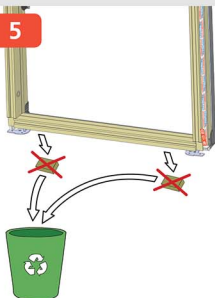

6

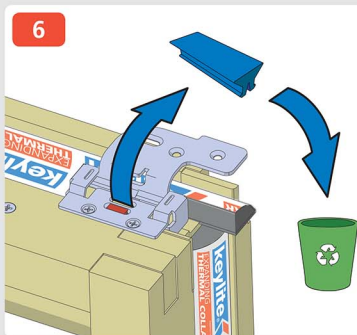

7

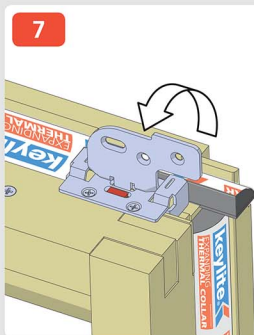

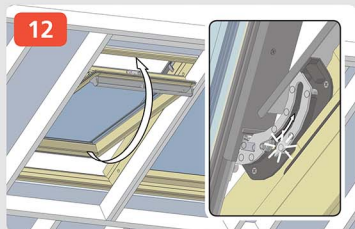
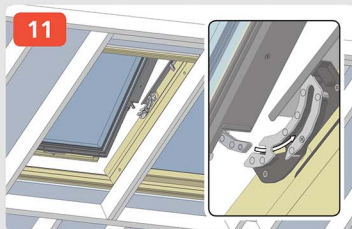
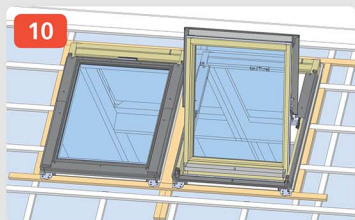
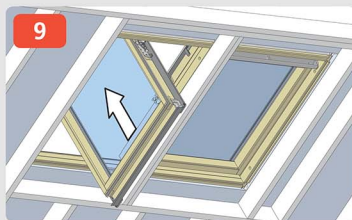
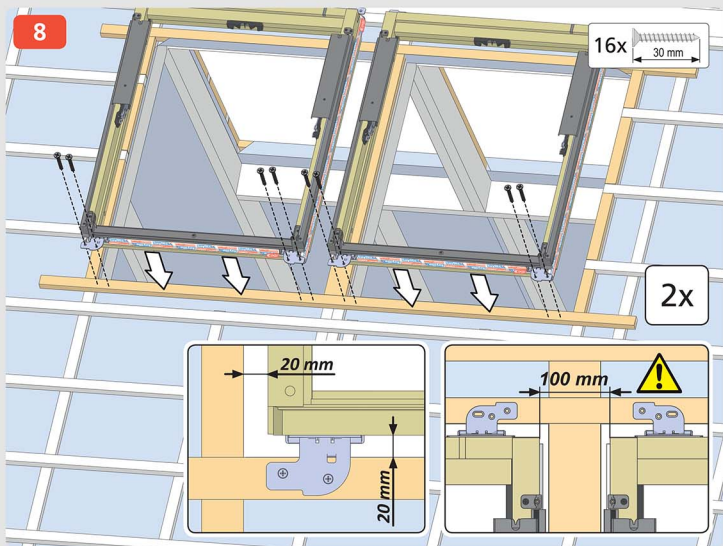

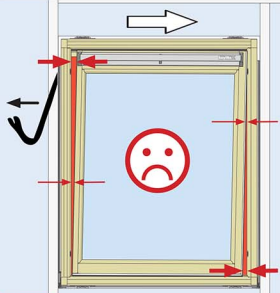

13

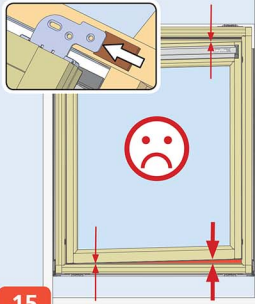

15

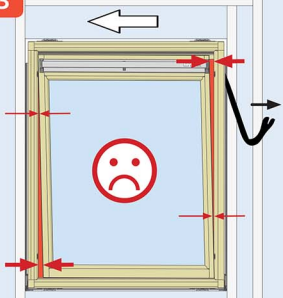

14

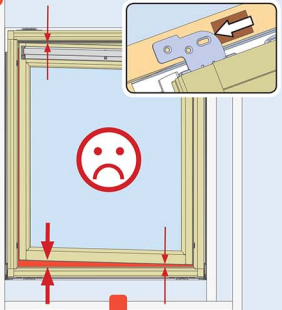

16

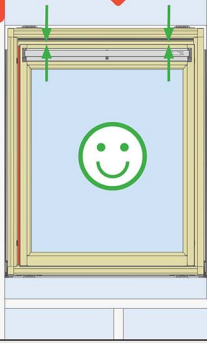
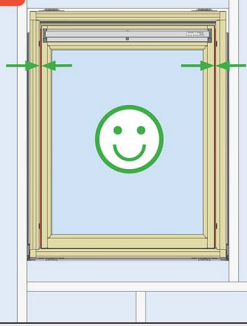

17

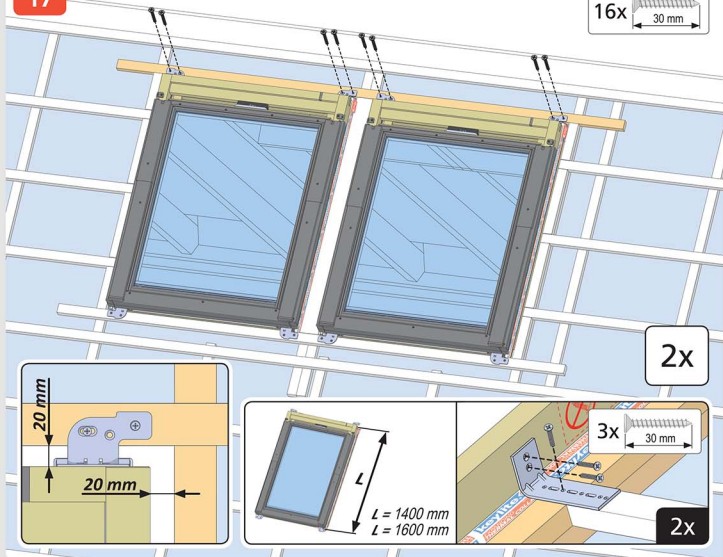
16x  30 mm

2x

3x  30 mm

2x

4x 

18

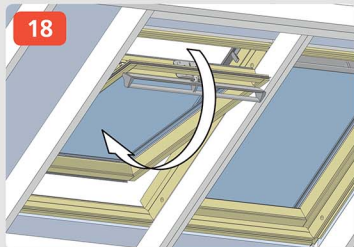

19

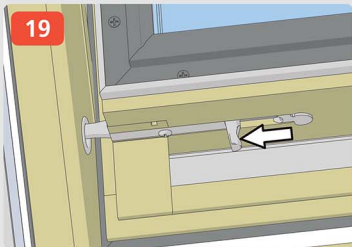

20

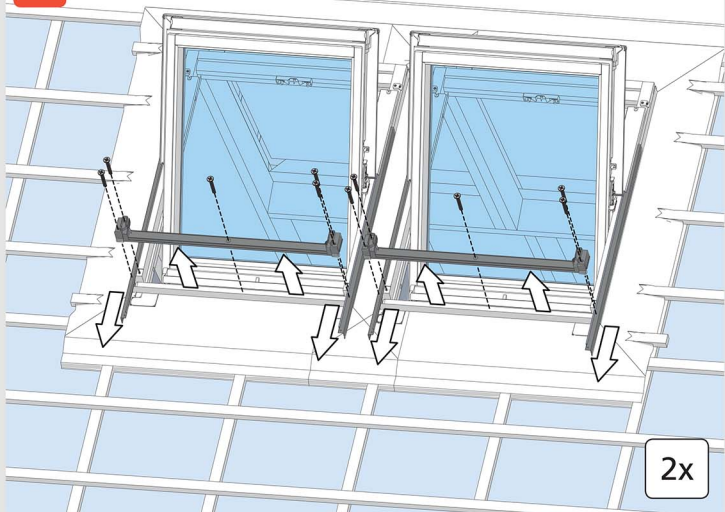

2x

21



2x

22



23

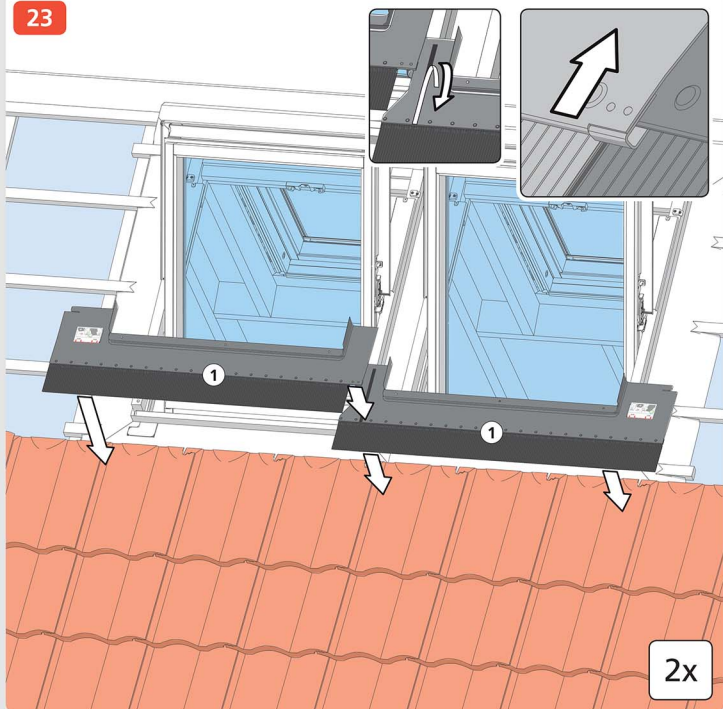

2x

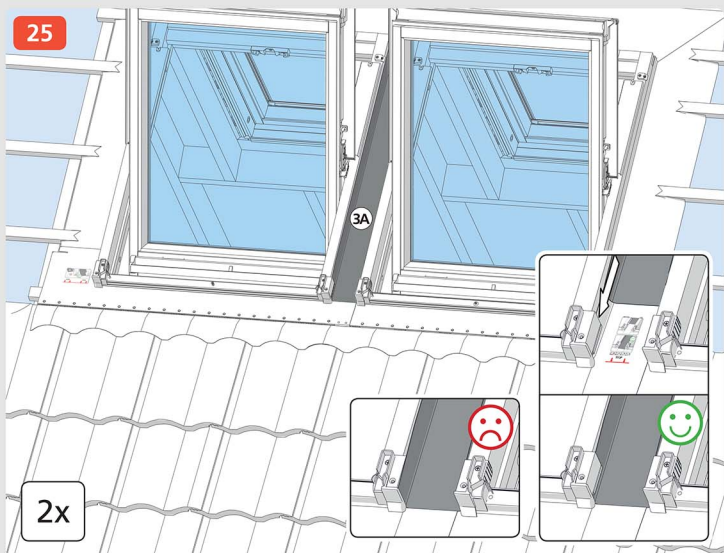
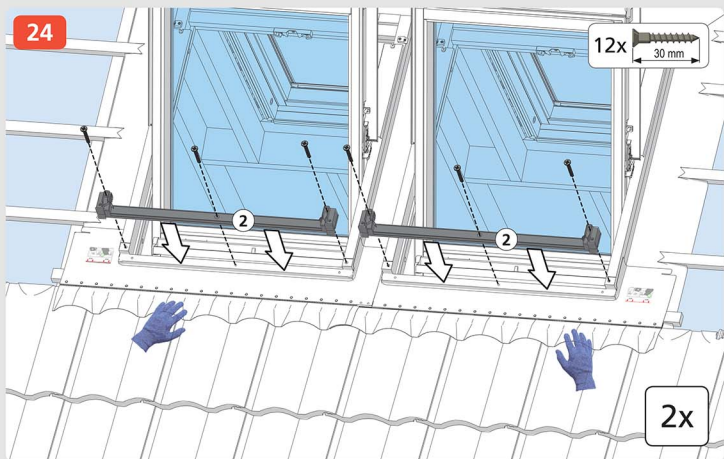

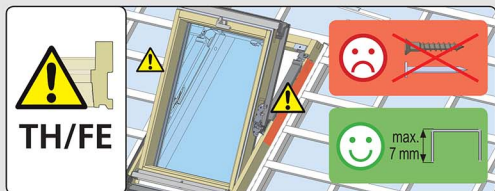
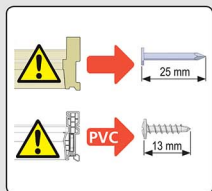

26

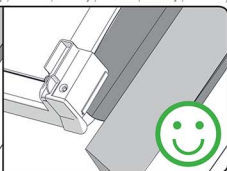
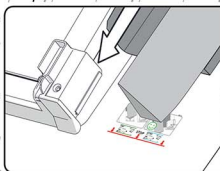
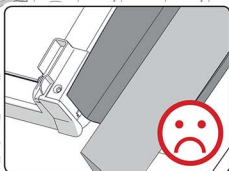
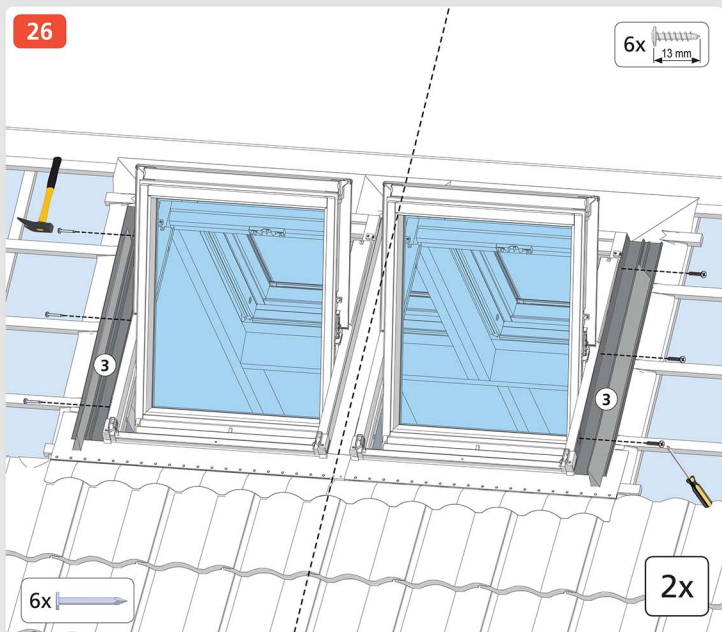

27

8x 30 mm

12x

12x

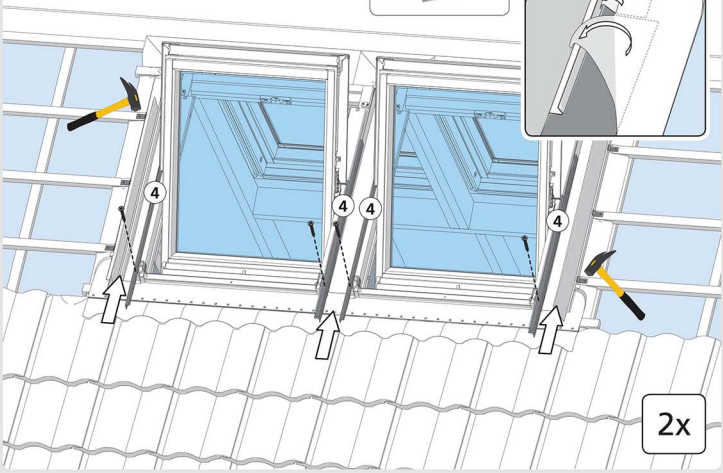

28a

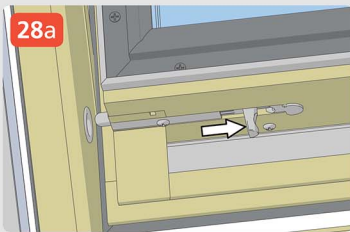

28b

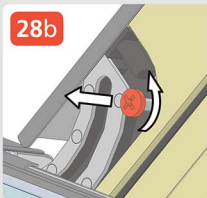

29

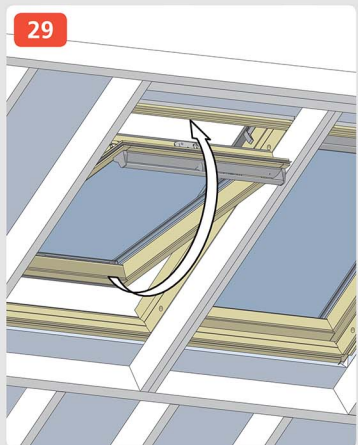

30



2x

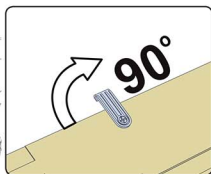

31

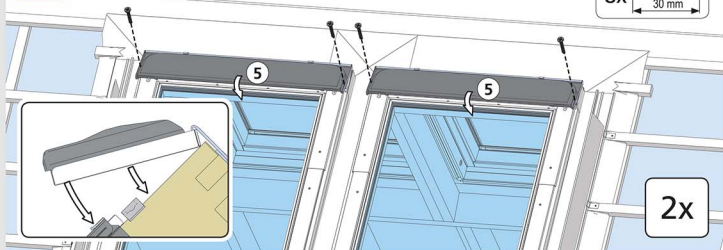
8x
30 mm

2x

32

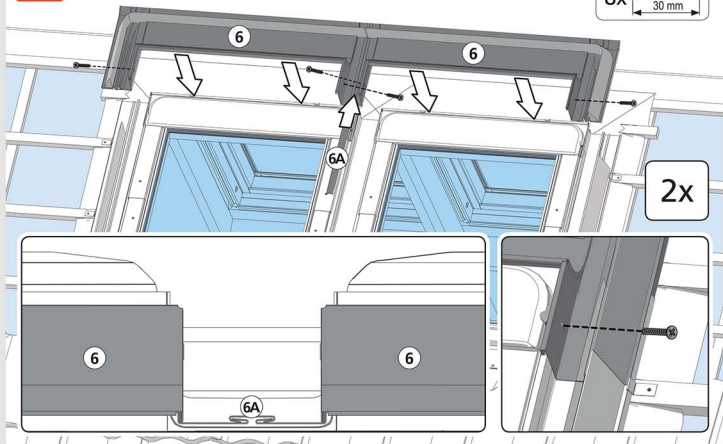
8x
30 mm

2x

33

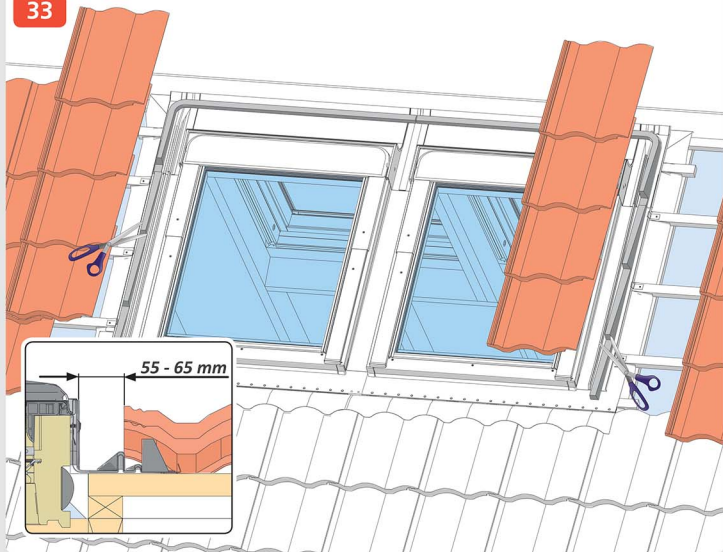

34

