

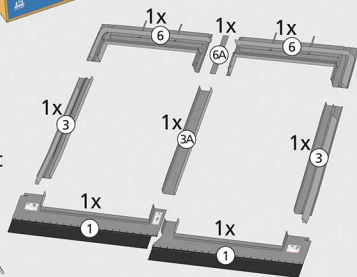

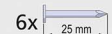

C TRF 100

C TRF 50

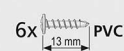
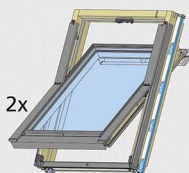
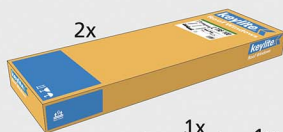
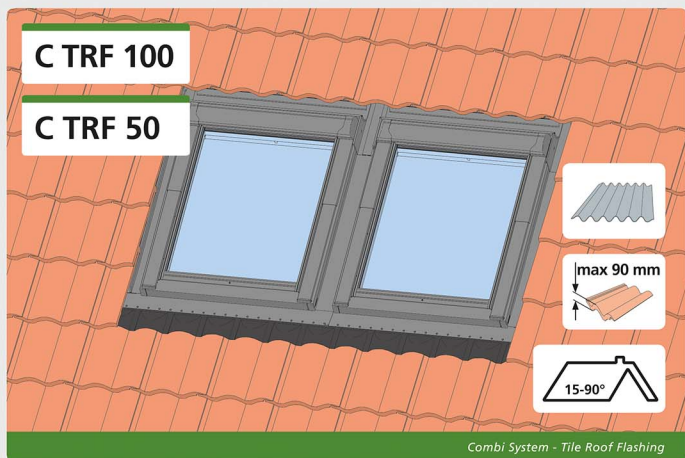

 $Z = 120 \text{ mm} - 140 \text{ mm}$

max 90 mm

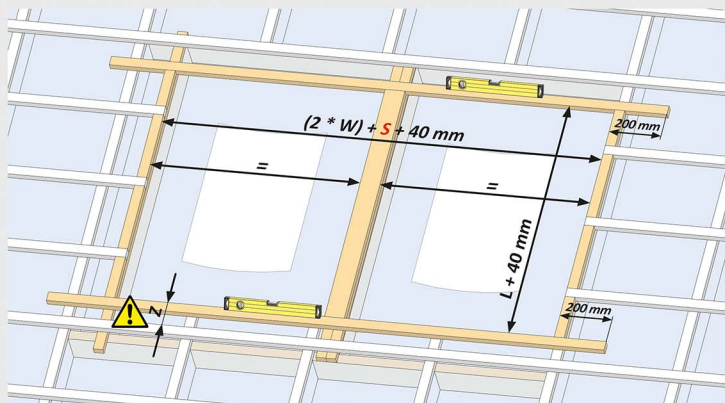
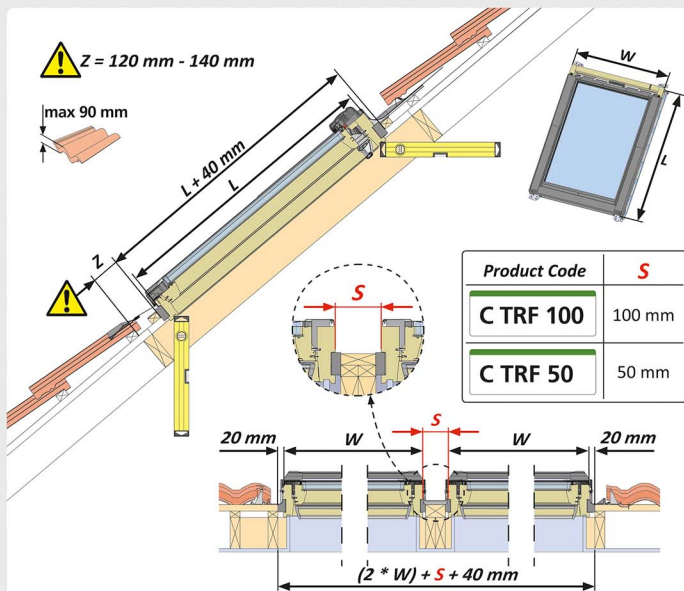

i

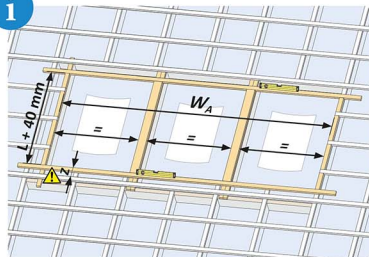

Q_{ty}	W_A
2	$(2 * W) + S + 40 \text{ mm}$
3	$(3 * W) + (2 * S) + 40 \text{ mm}$
X	$(X * W) + ((X - 1) * S) + 40 \text{ mm}$

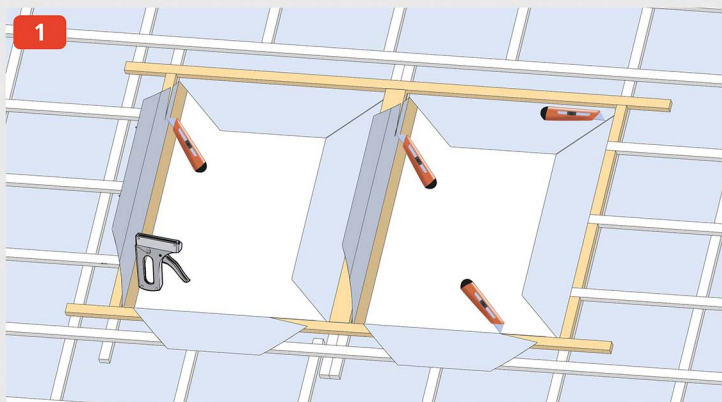
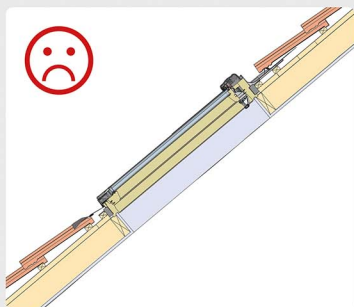

2a

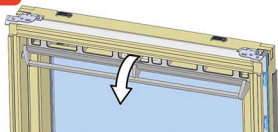

2b

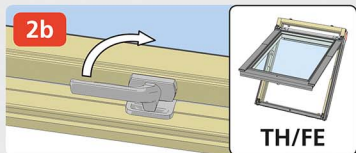

3

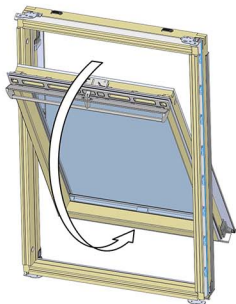

4

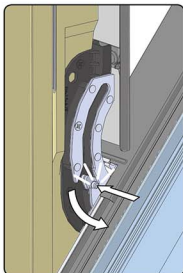

5

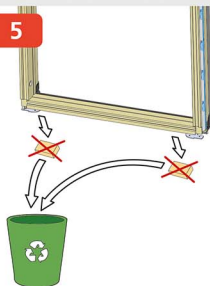

6

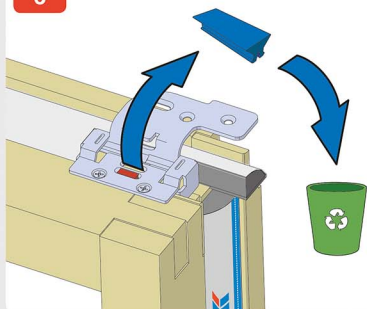

7

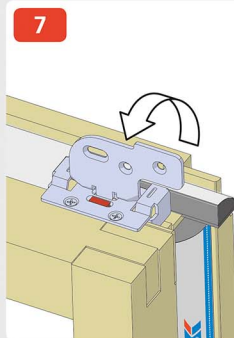

8

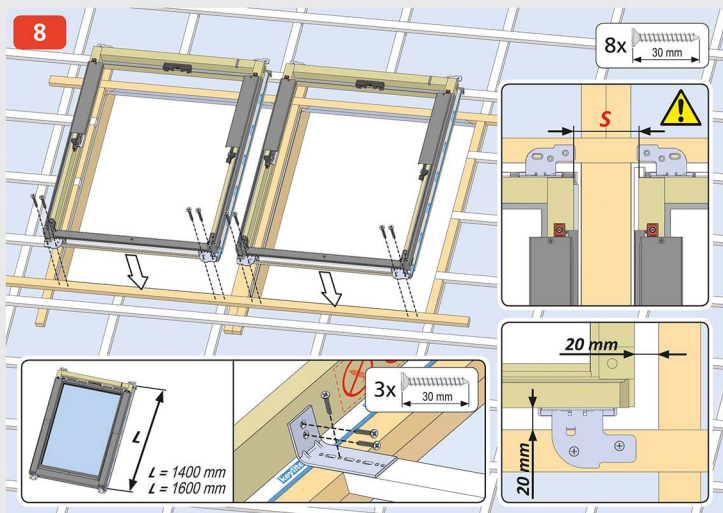

9

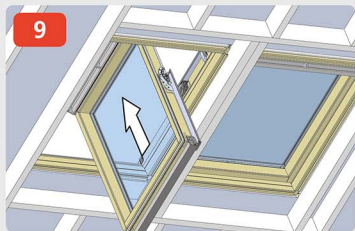

10

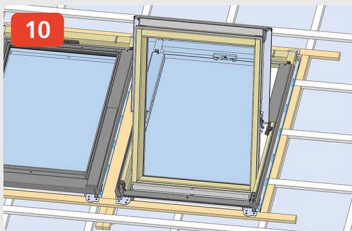

11

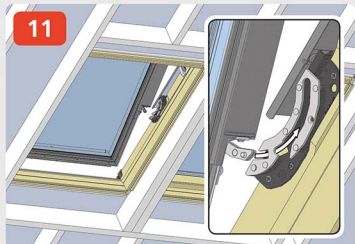

12

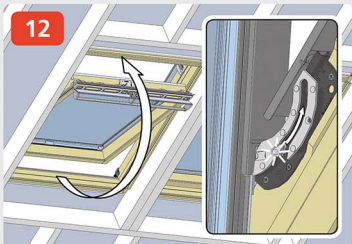

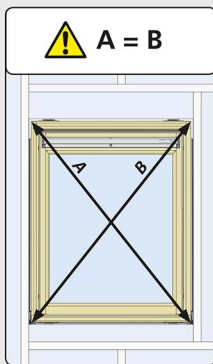
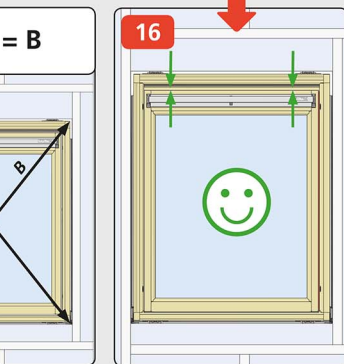
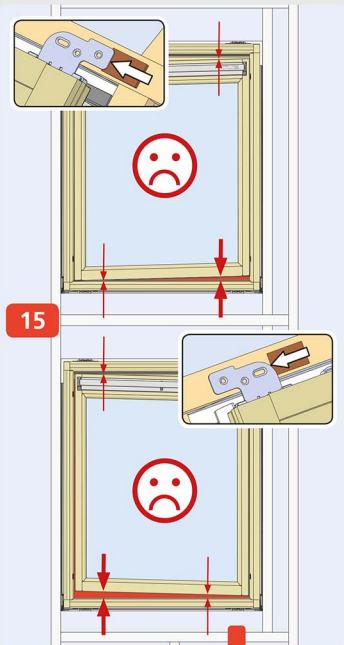
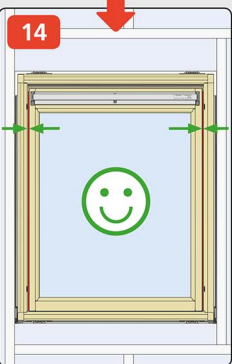
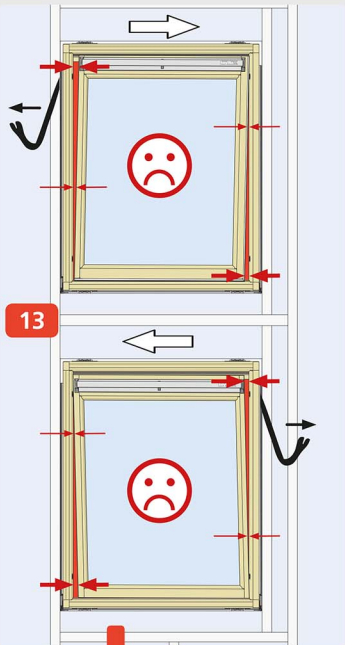

17

8x

30 mm

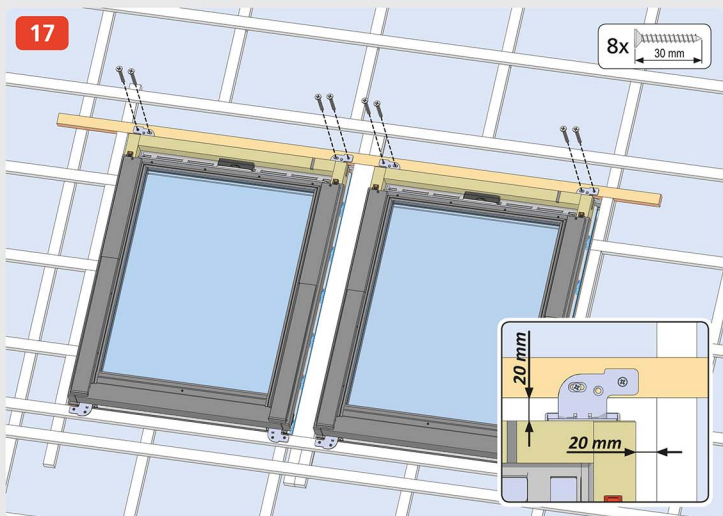

2x



18

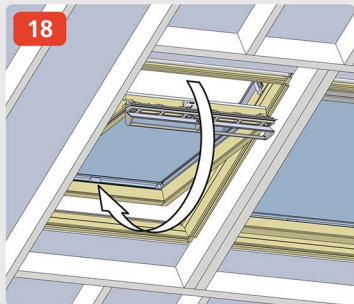

19

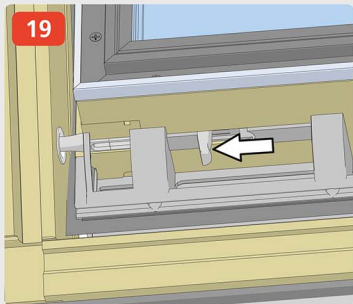

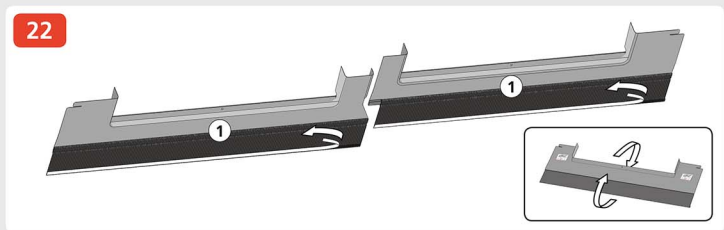
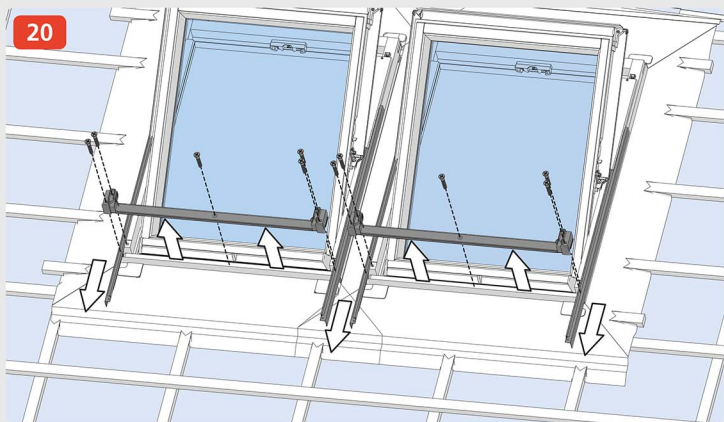

23

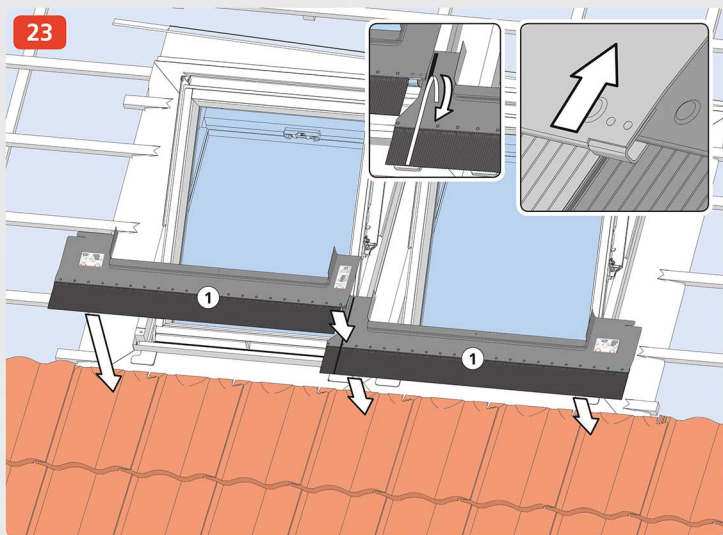

24

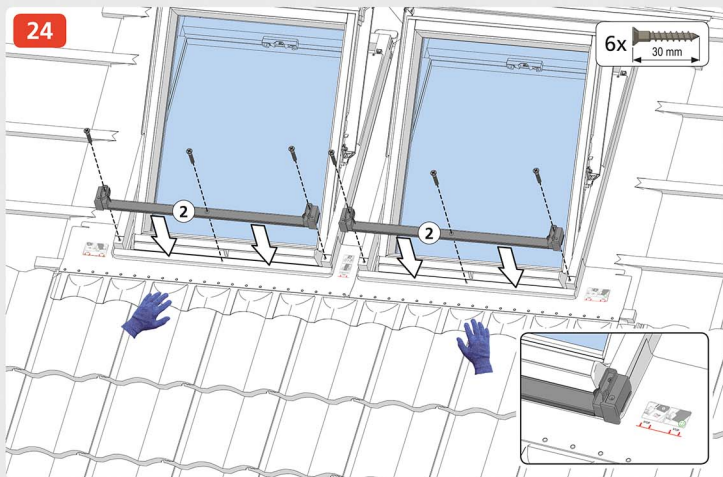

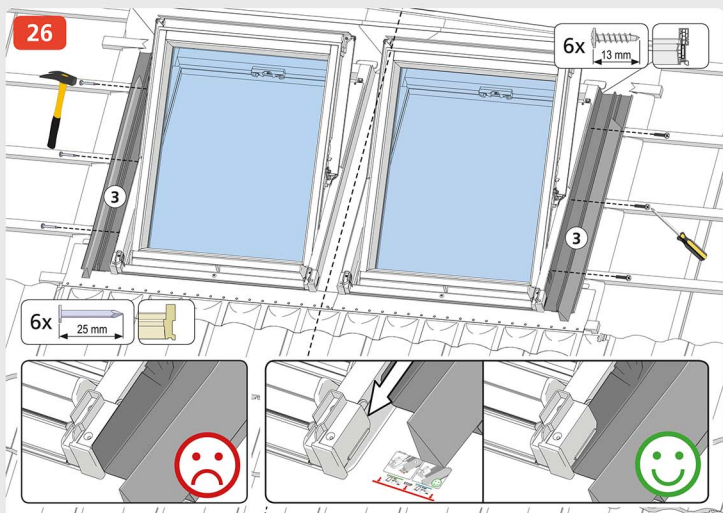
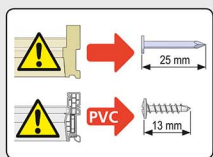
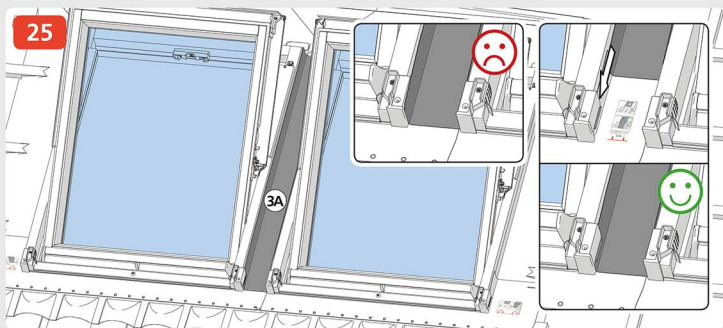

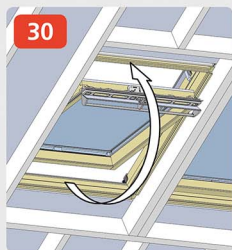
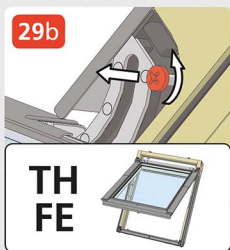
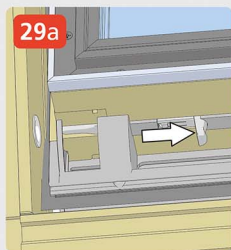
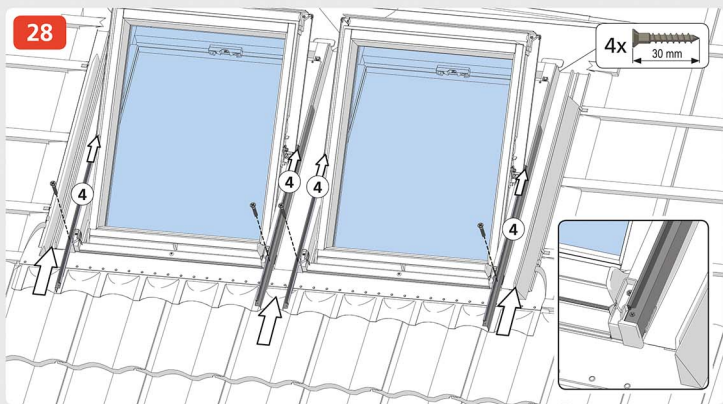
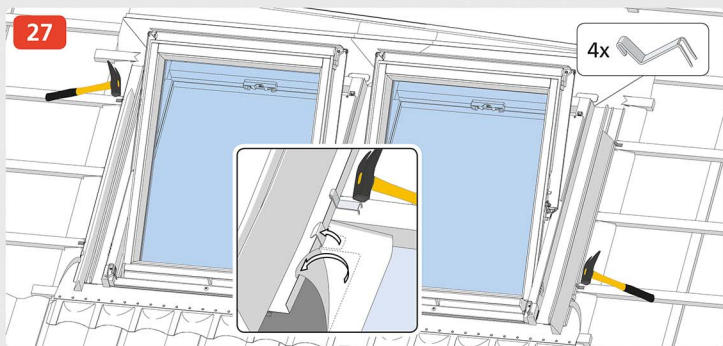

31

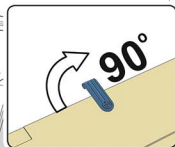
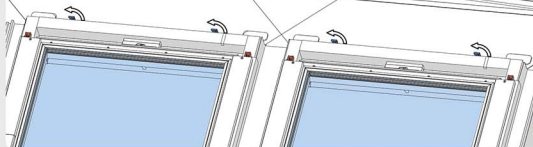

32a

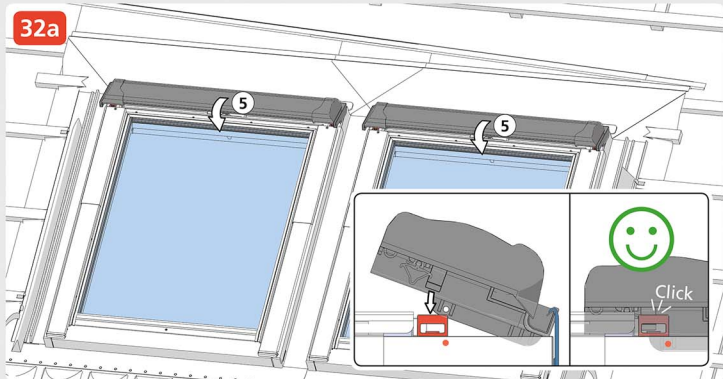

32b

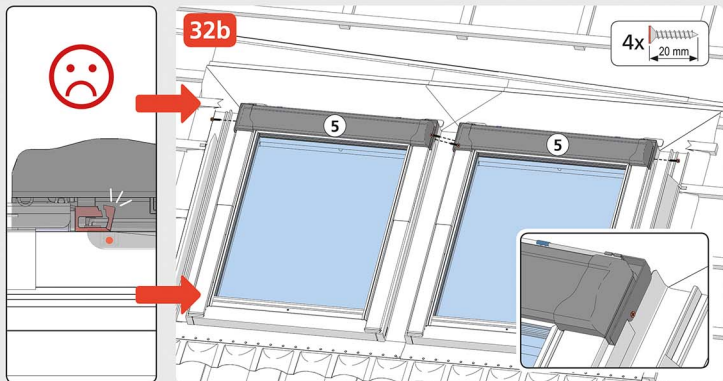



C TRF 100

S = 100 mm

33a

4x  30 mm

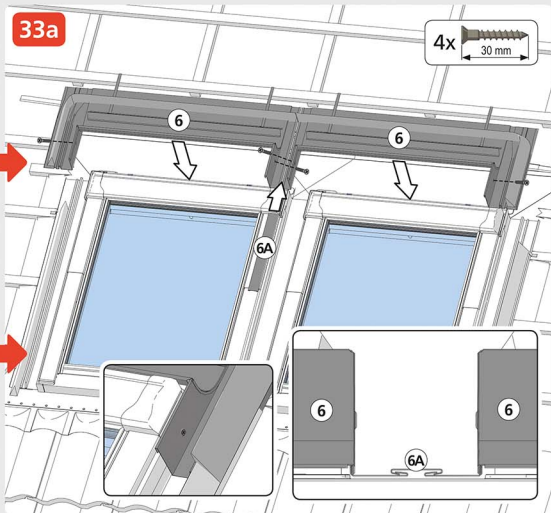

C TRF 50

S = 50 mm

33b

4x  30 mm

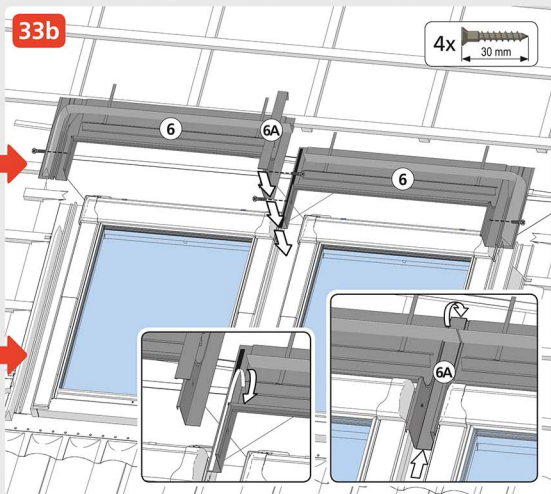

34



35

