

7a

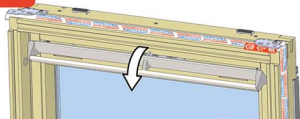

7b

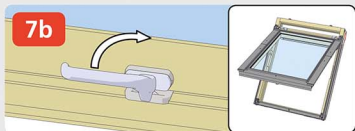

8

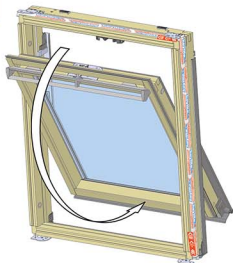

9

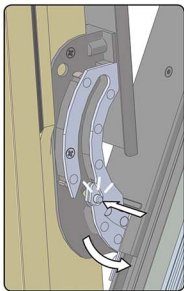
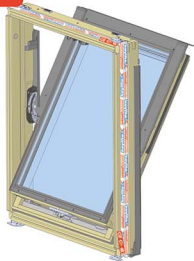

10

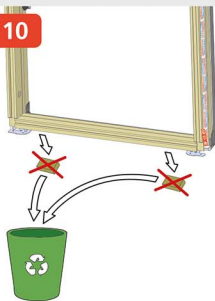

11

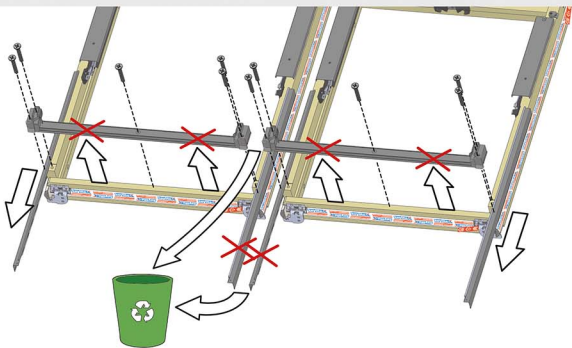

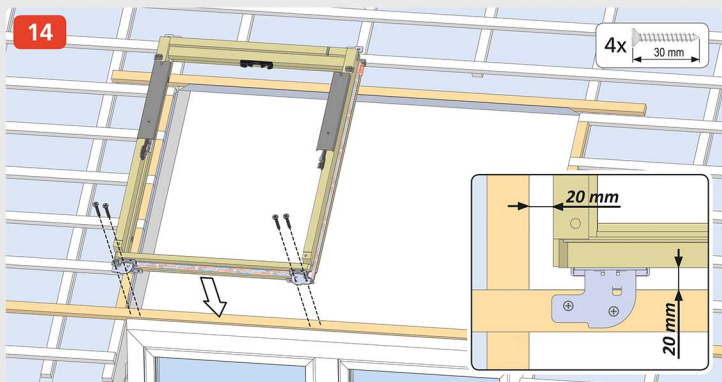
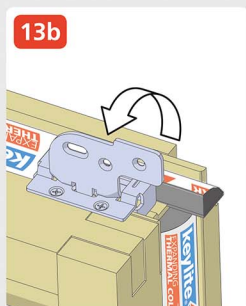
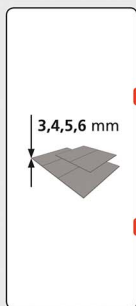
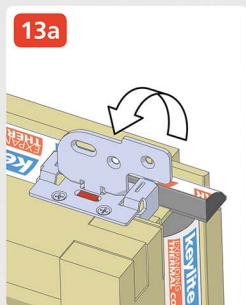
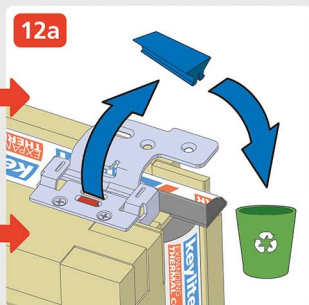

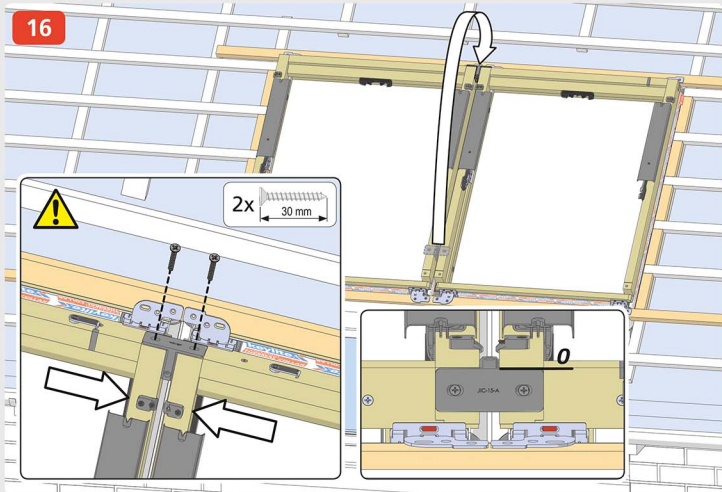
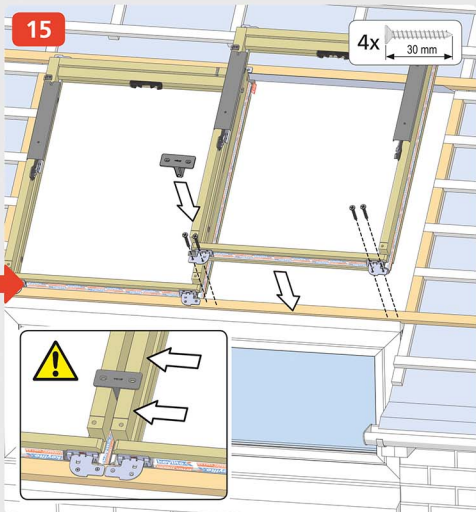
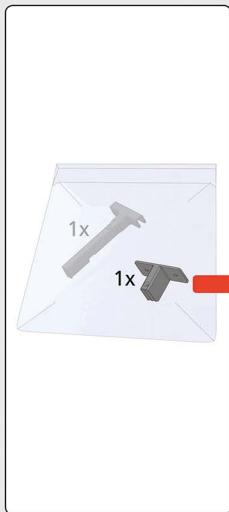

17

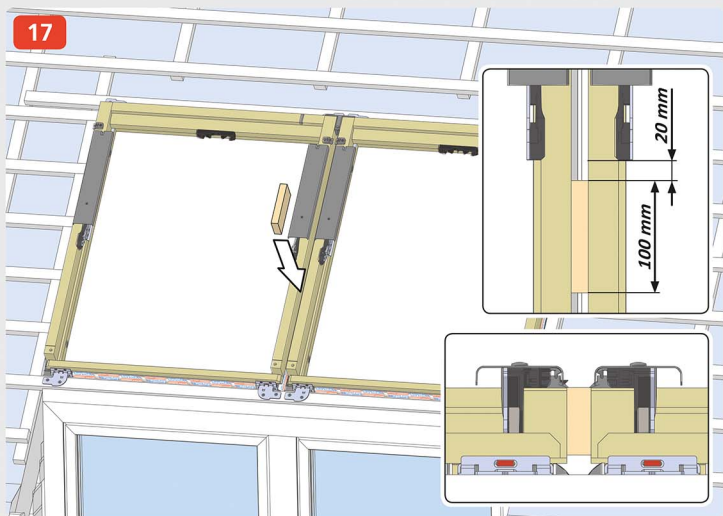

18

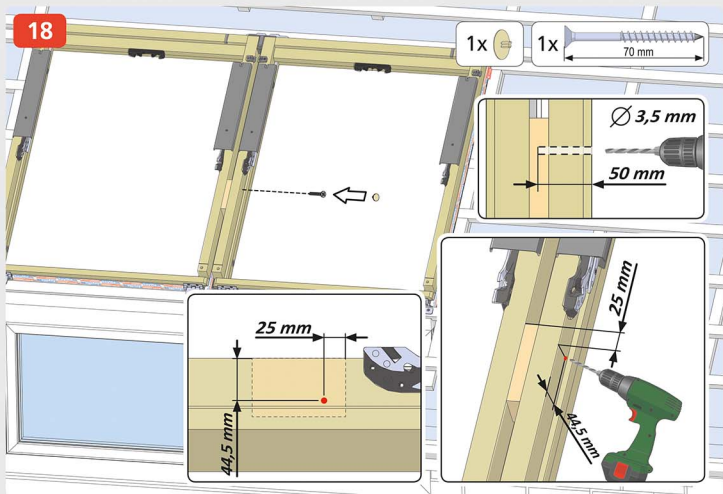



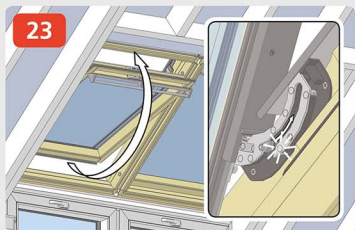
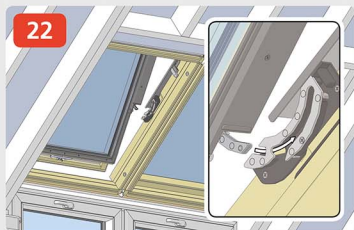
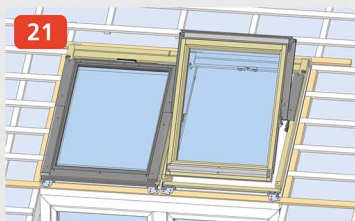
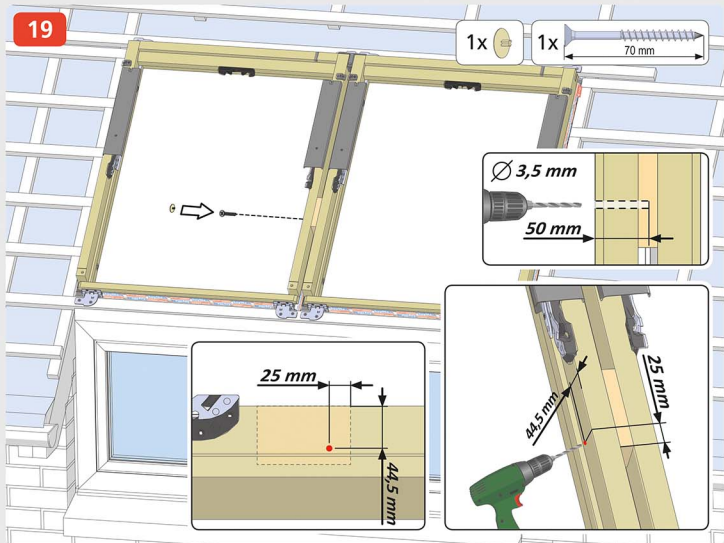

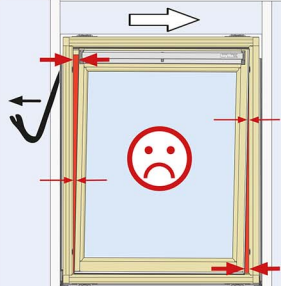

24

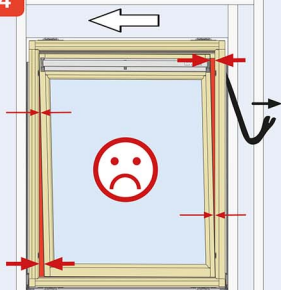

25

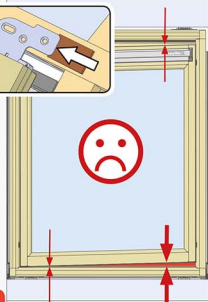
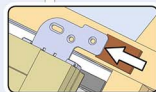
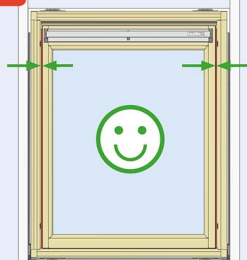

26

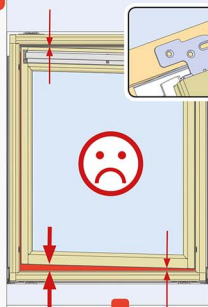
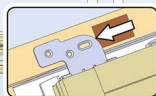

27



28

8x 30 mm

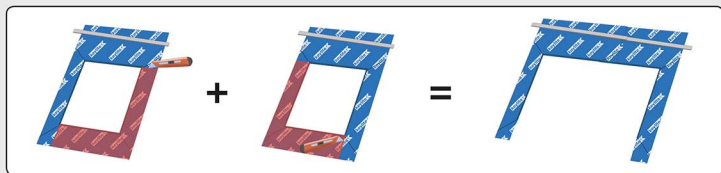
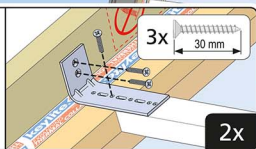
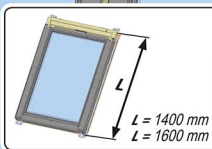
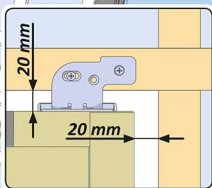

29

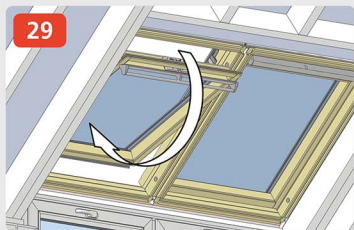

30

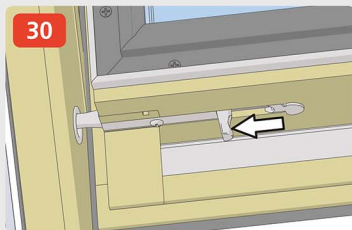

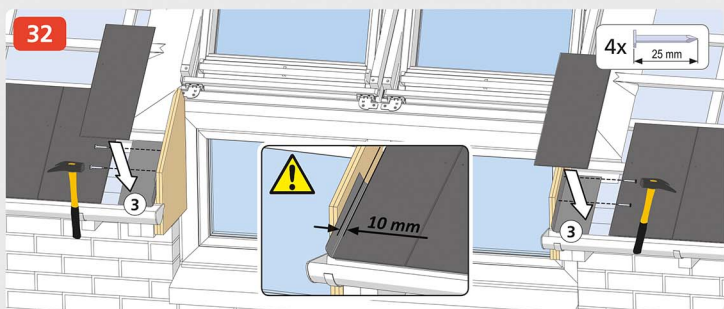
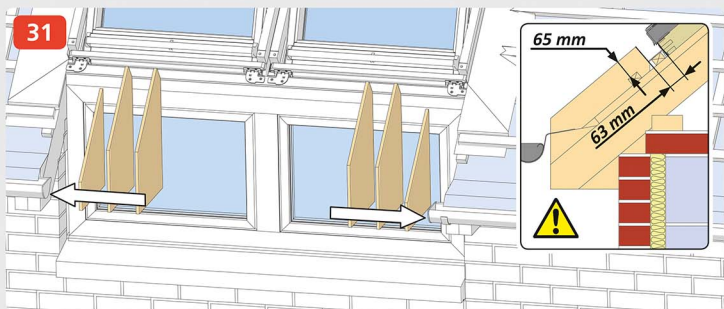

34

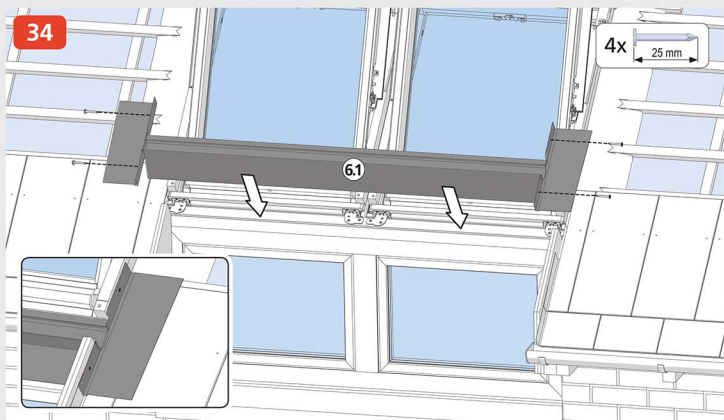

35

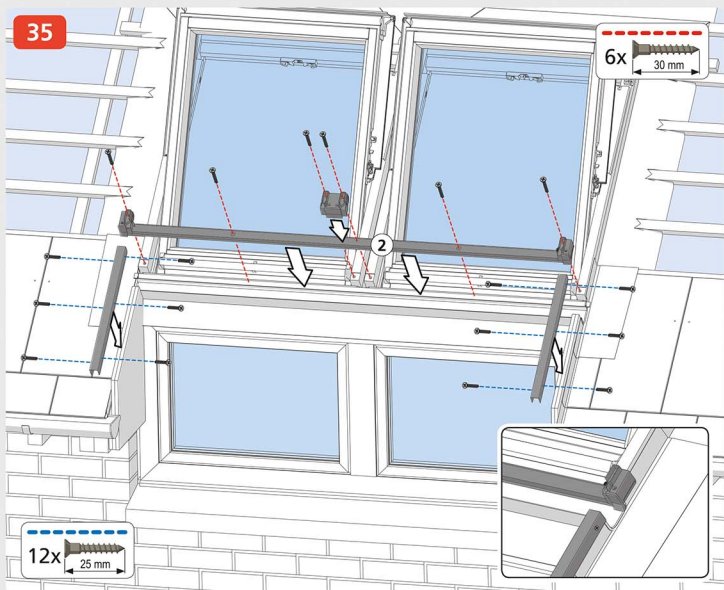

36

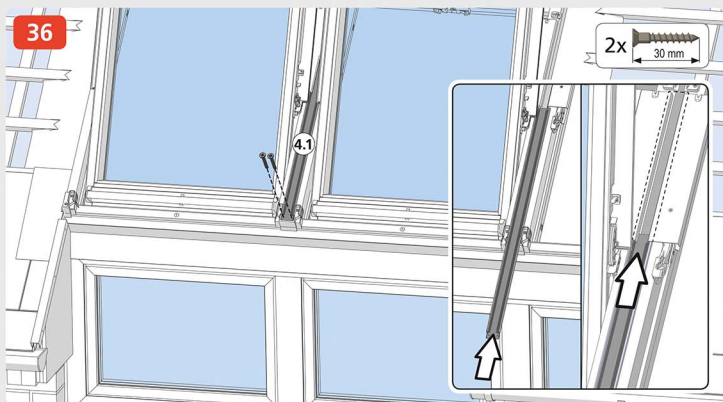

37

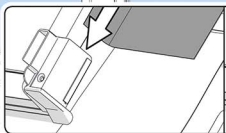
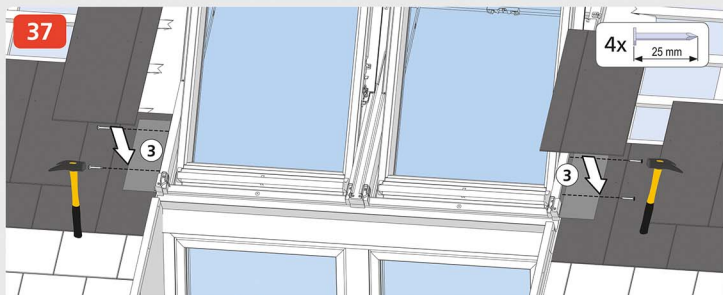

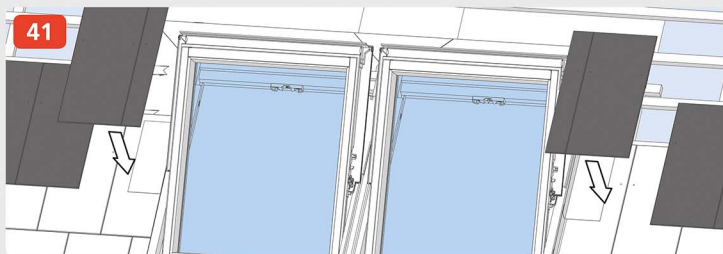
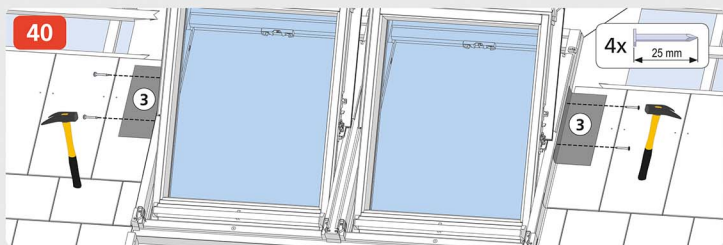
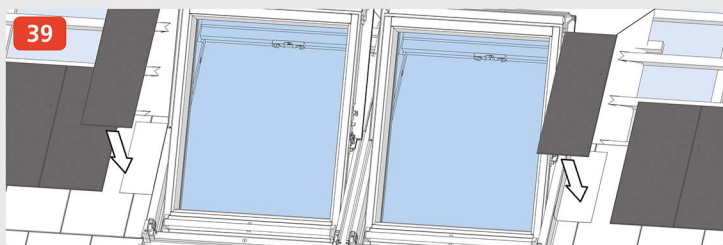
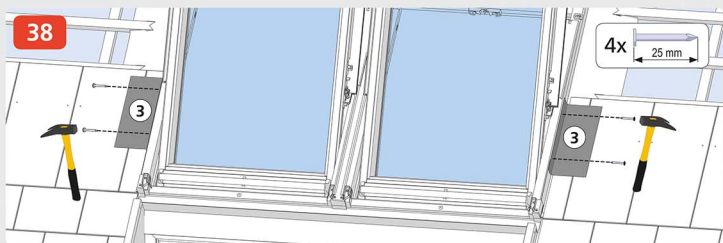

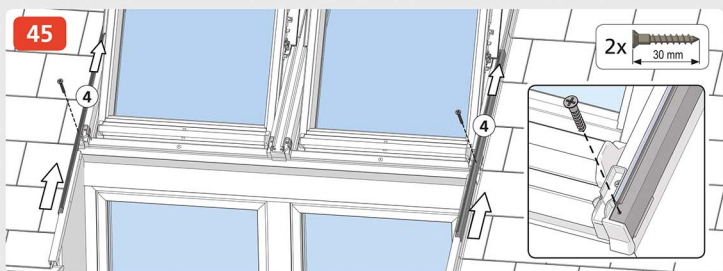
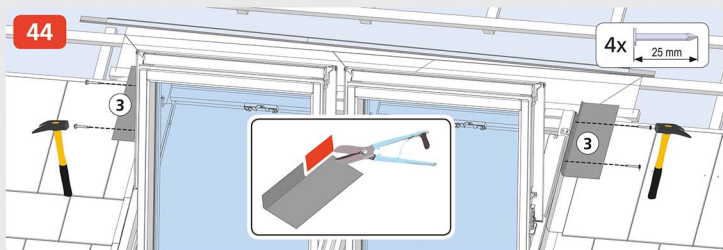
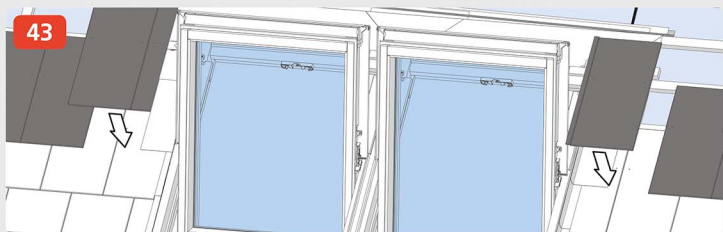
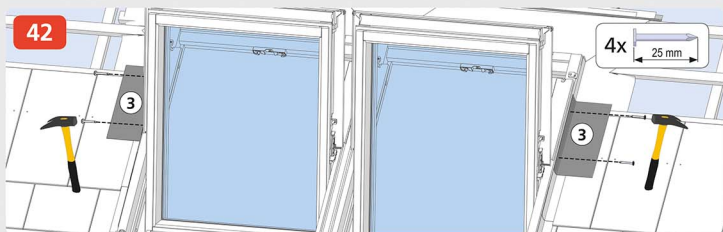



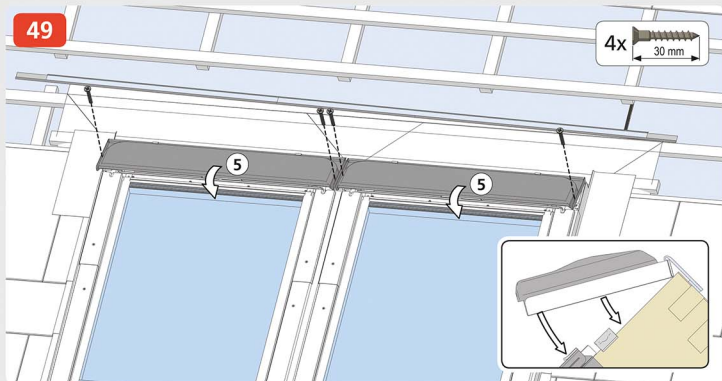
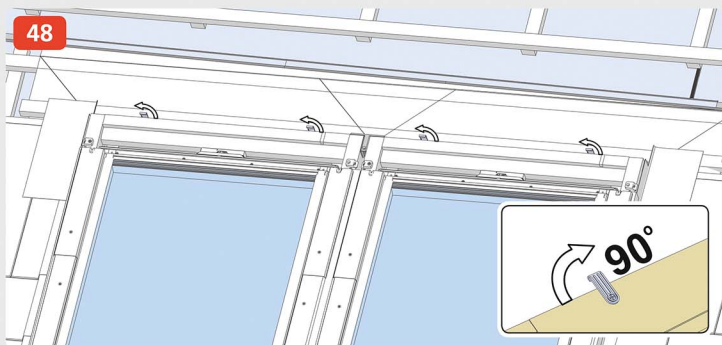
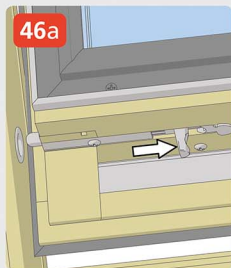

50

2x 30 mm

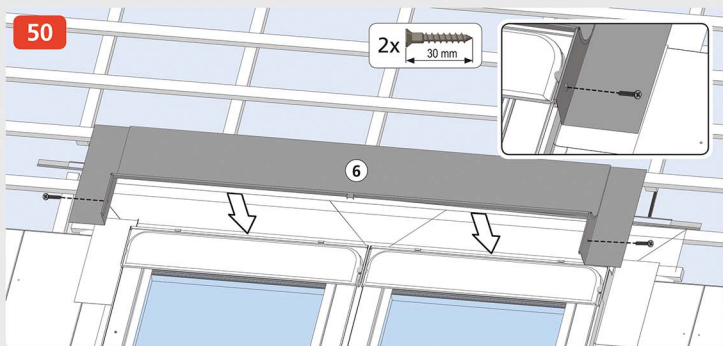

51

1x 60 mm

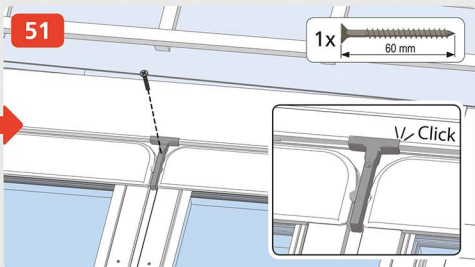
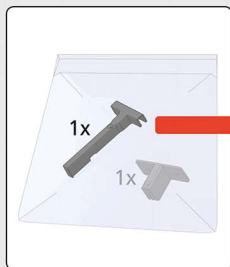

52

