

	X	Y
DRX4 04	1550 mm	2095 mm
DRX4 05	1550 mm	2470 mm
DRX4 07B	1870 mm	2095 mm
DRX4 07C	1870 mm	2470 mm
DRX4 08B	2270 mm	2095 mm
DRX4 08	2270 mm	2470 mm
DRX6 04	2350 mm	2095 mm
DRX6 05	2350 mm	2470 mm

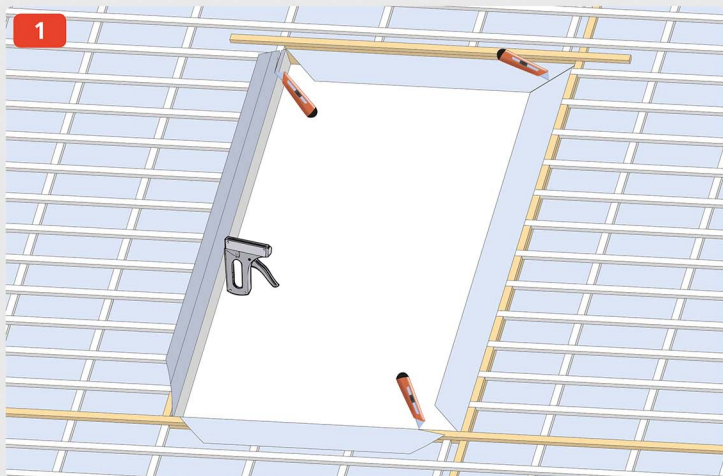
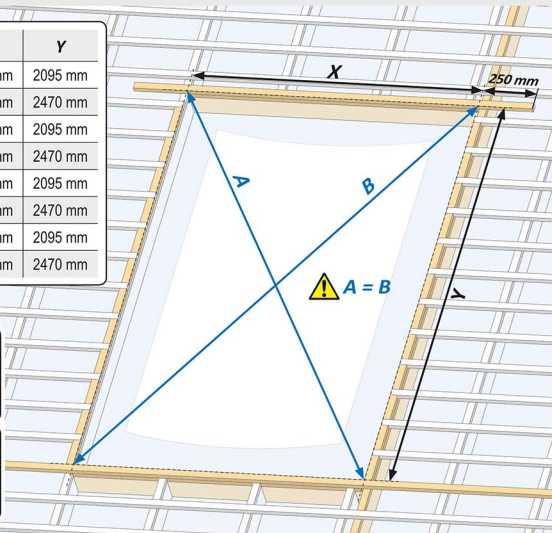
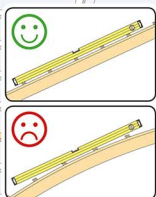

2

4x

90 mm

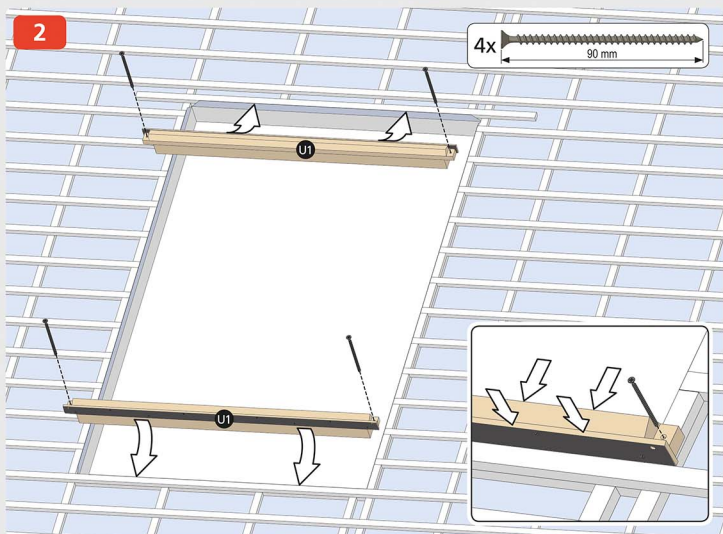

3

12x

70 mm

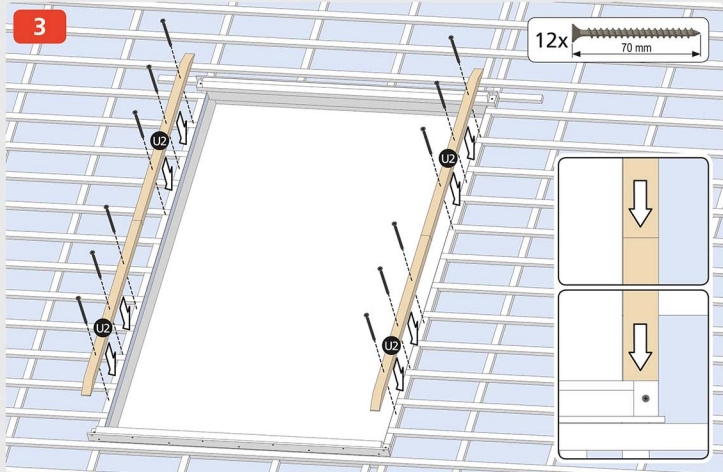

4

4

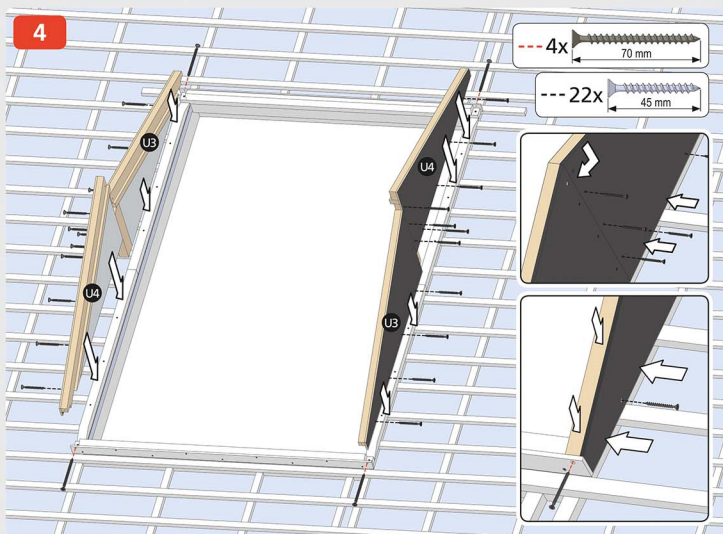

5

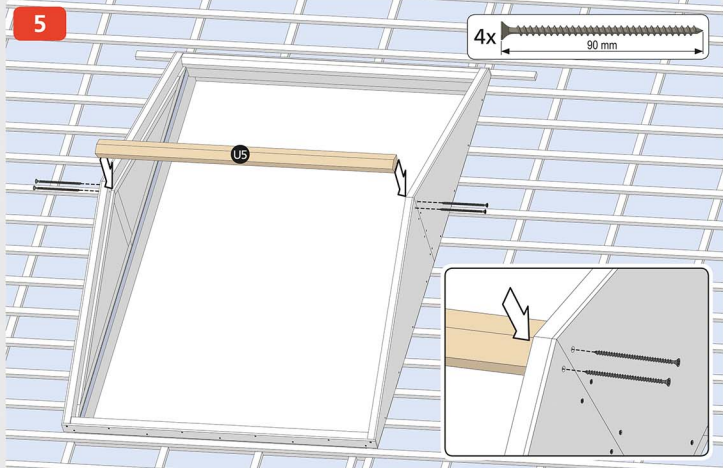

6

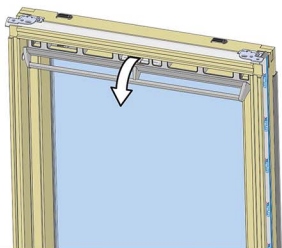

7

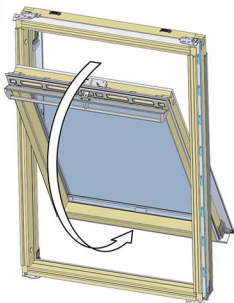

8

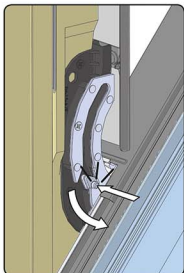

9

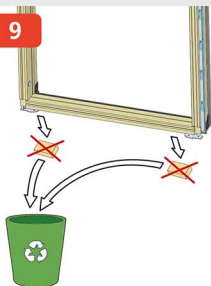

10

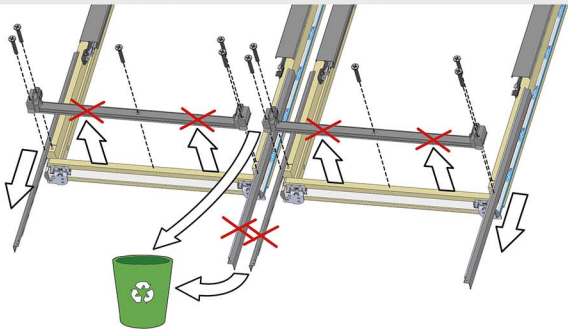

11

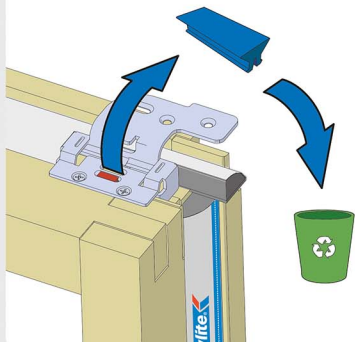

12

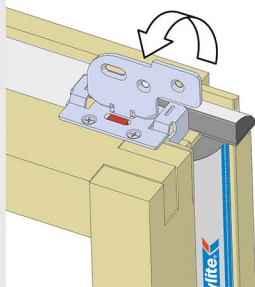

13

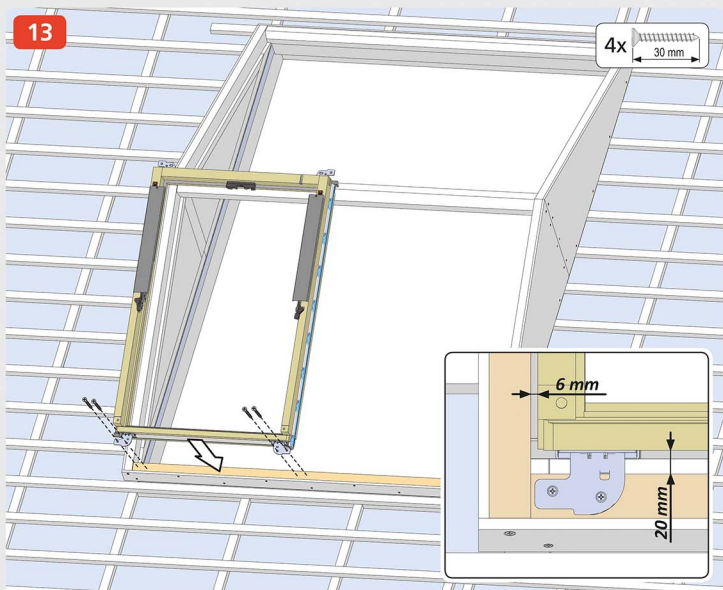



14

4x 30 mm

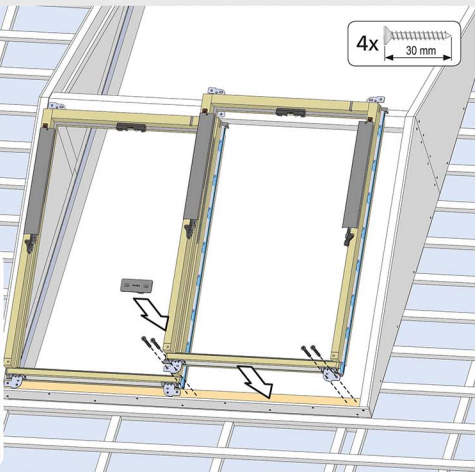
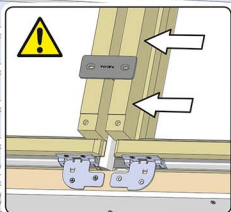

15

2x 30 mm

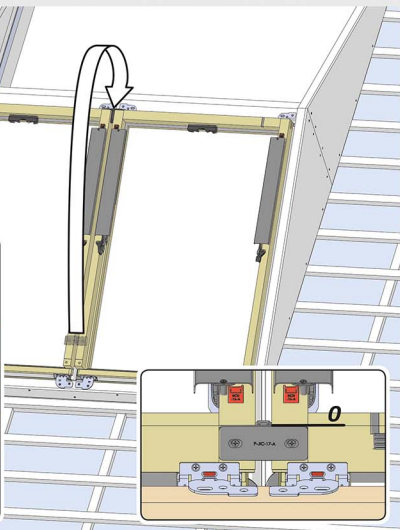
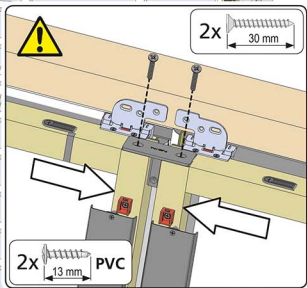



16

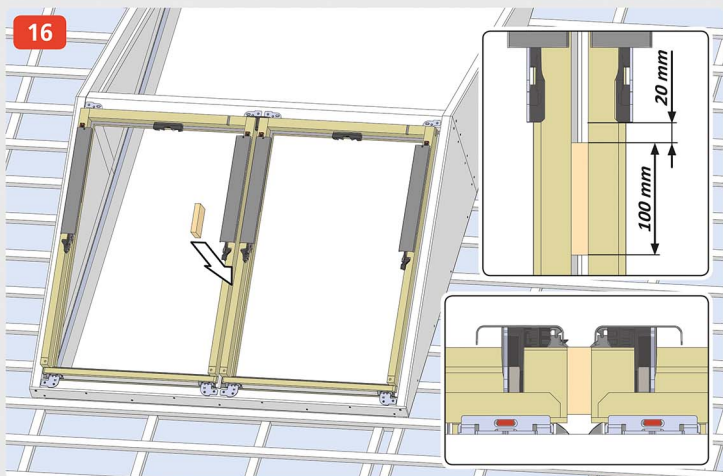

17

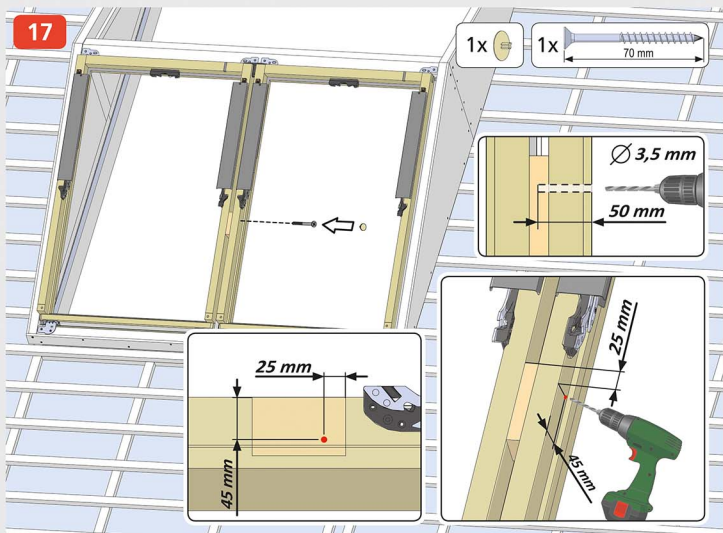

18

1x



1x



Ø 3,5 mm



50 mm

25 mm

45 mm

25 mm

45 mm

19

6

18

6

10

20

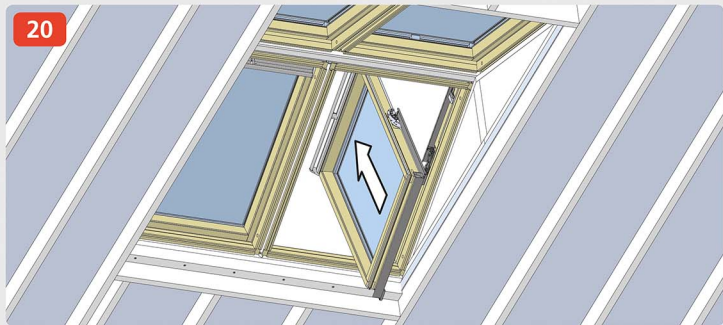

21

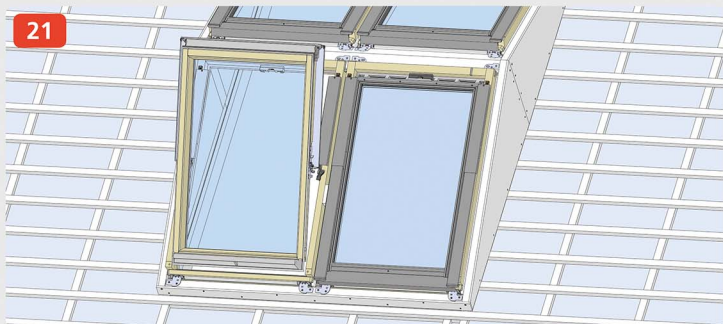

22

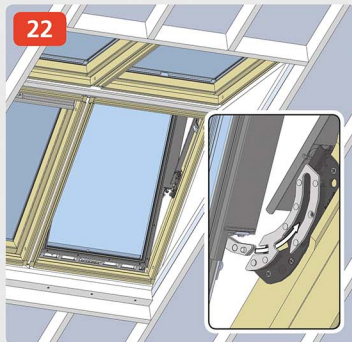

23

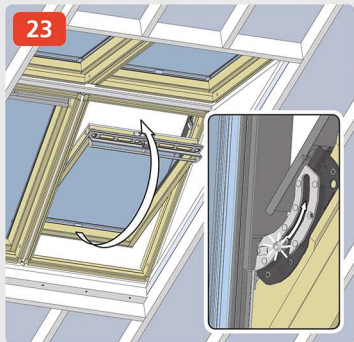

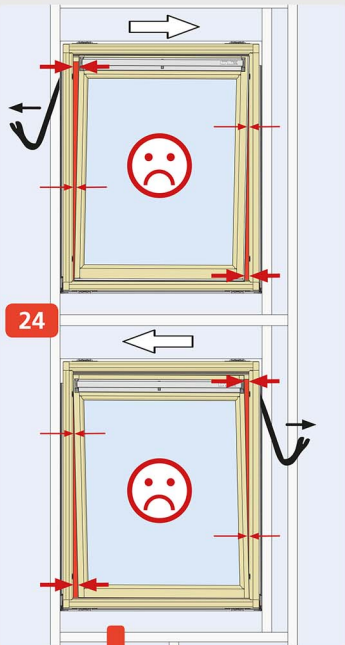

24

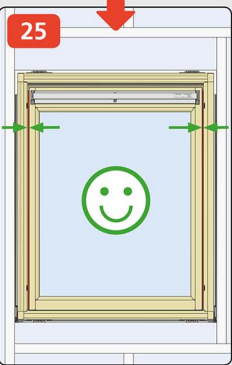

25

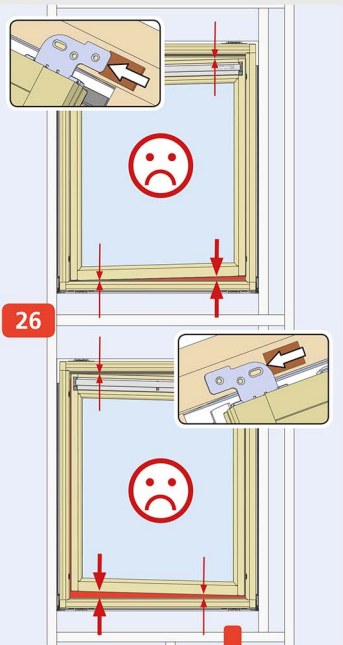

26

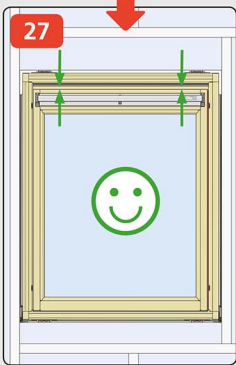
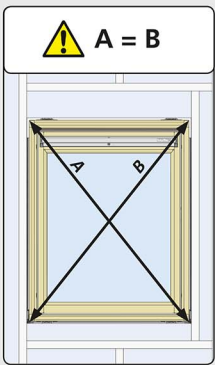

27

28

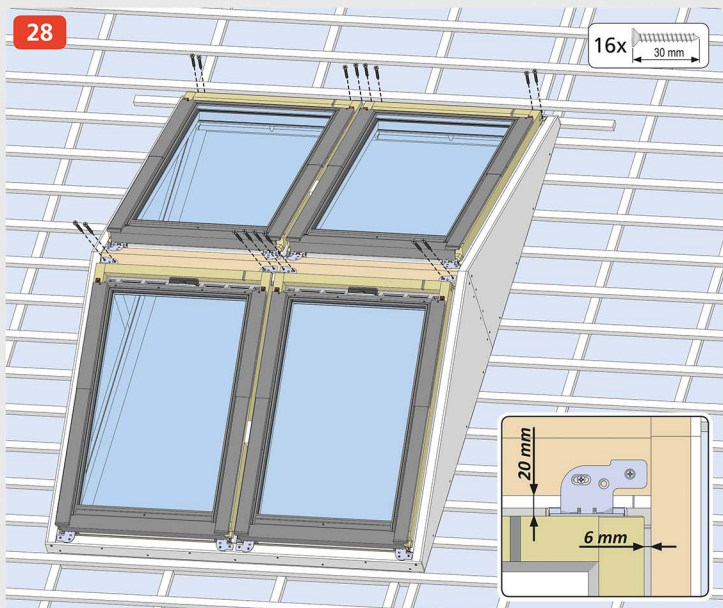
16x  30 mm

29

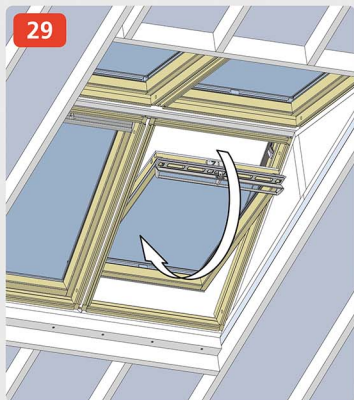

30

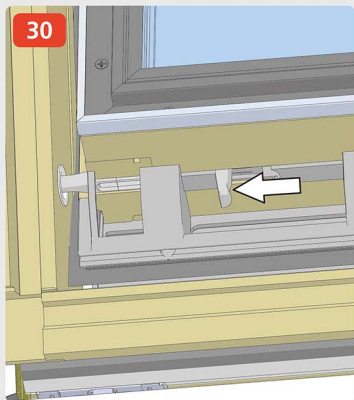



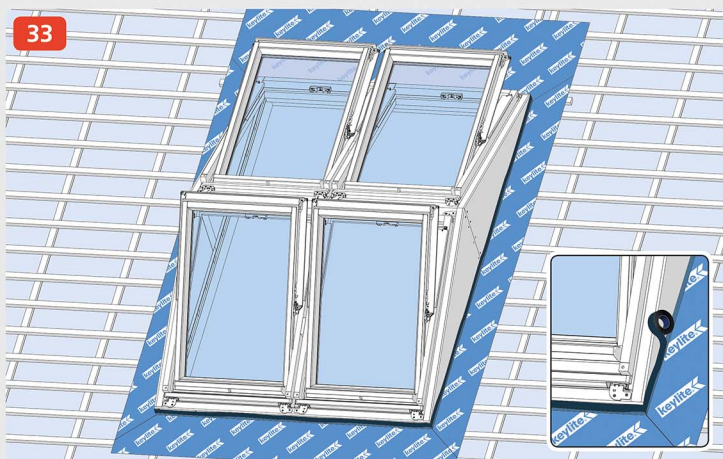
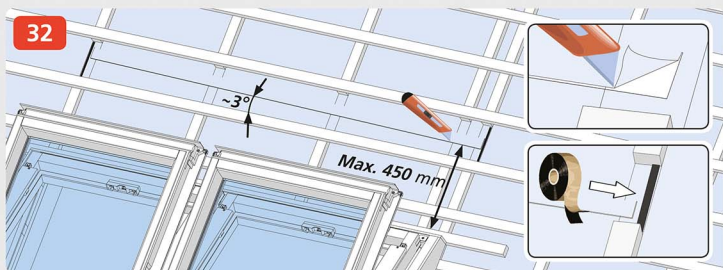
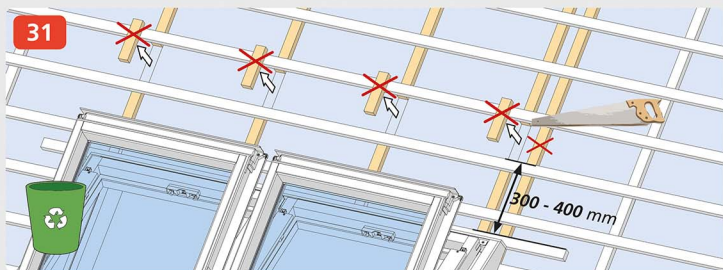



34

4x 

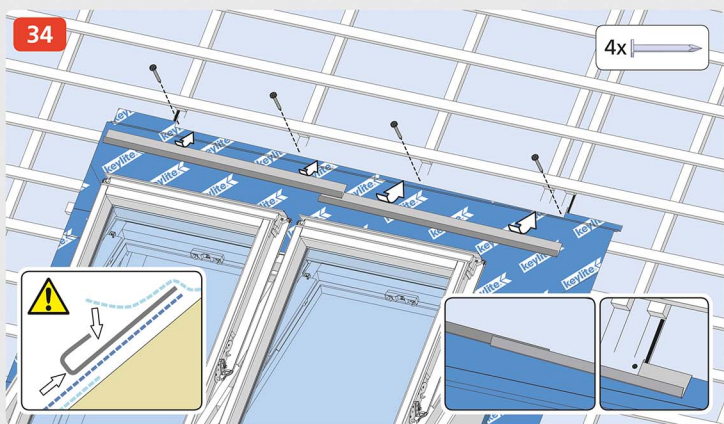

35

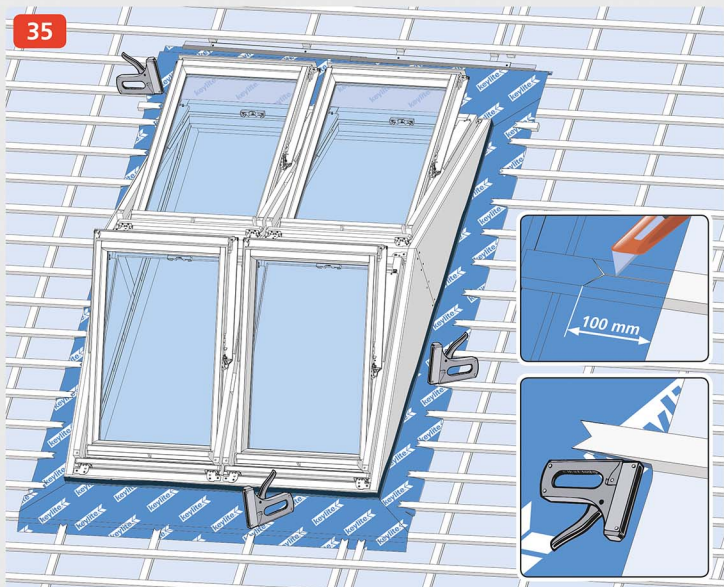

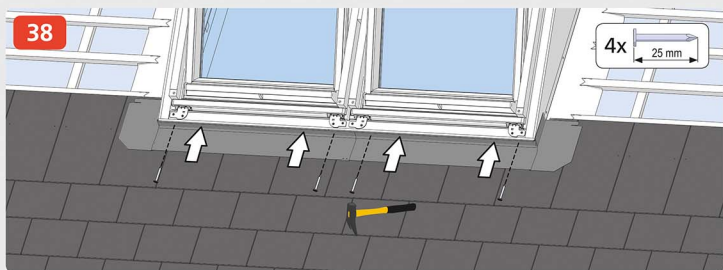
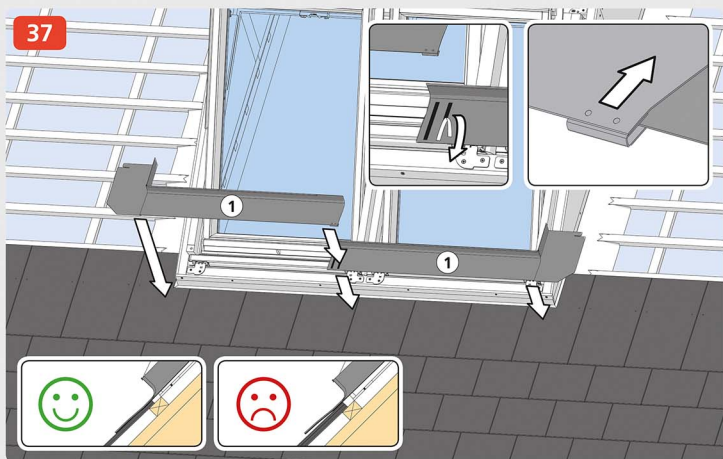
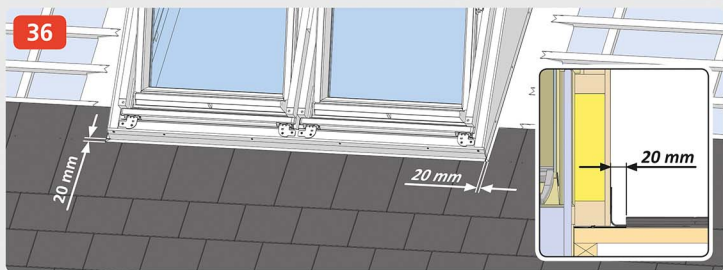

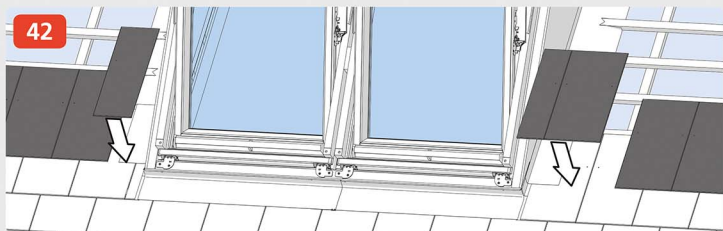
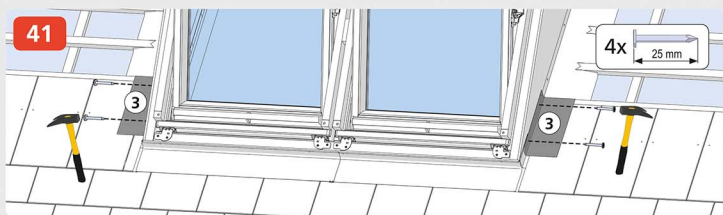
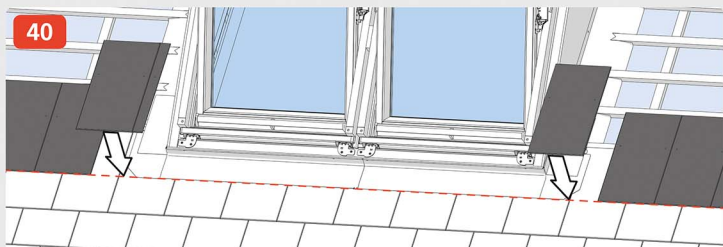

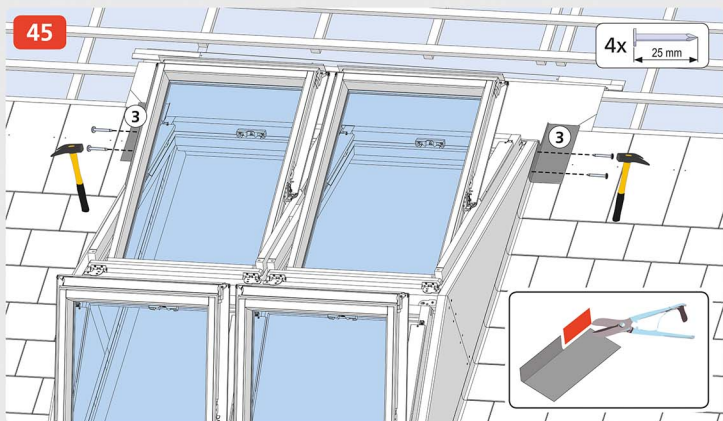
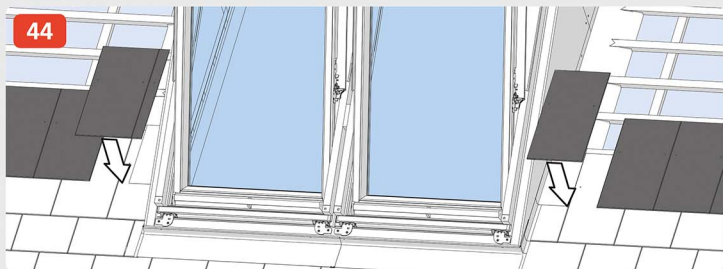
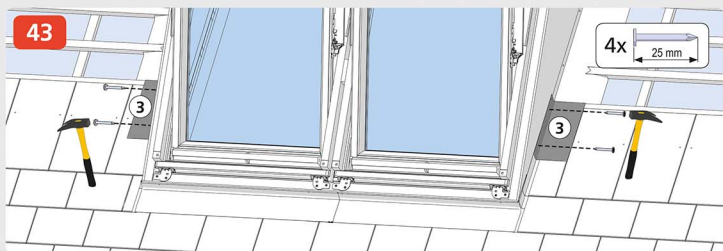

46

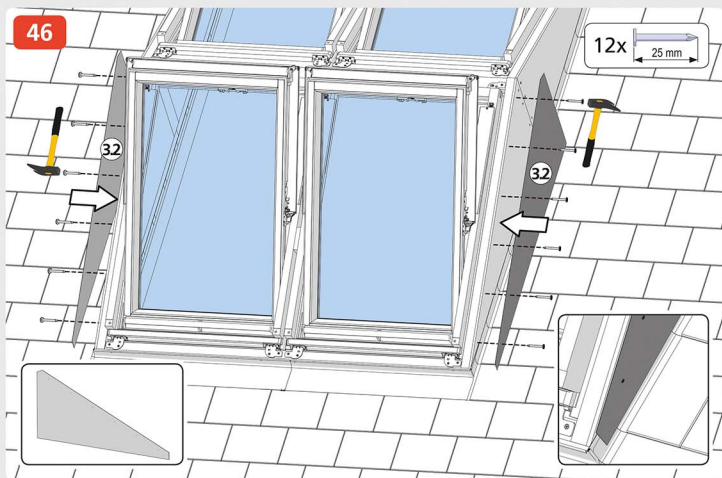

47

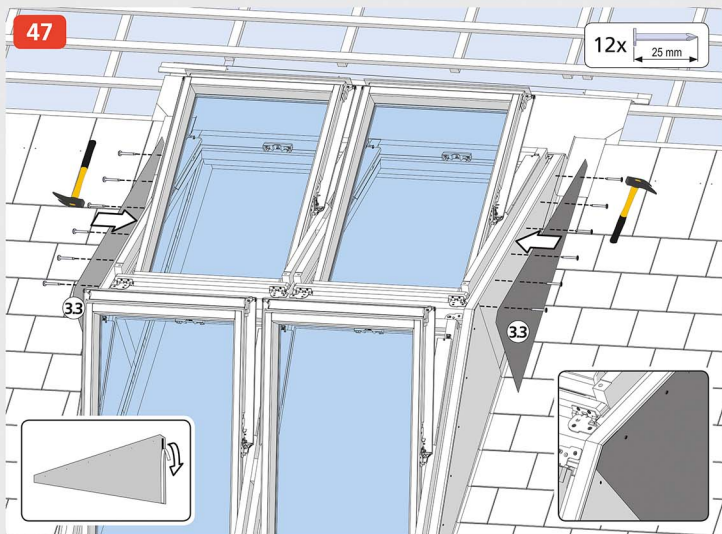

48

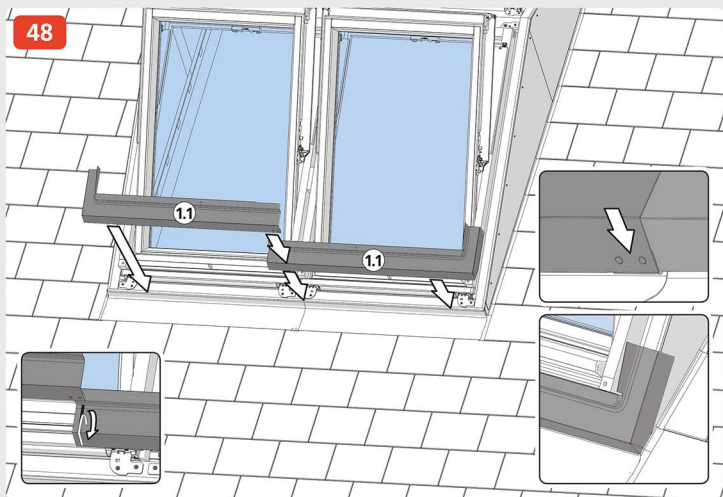

49

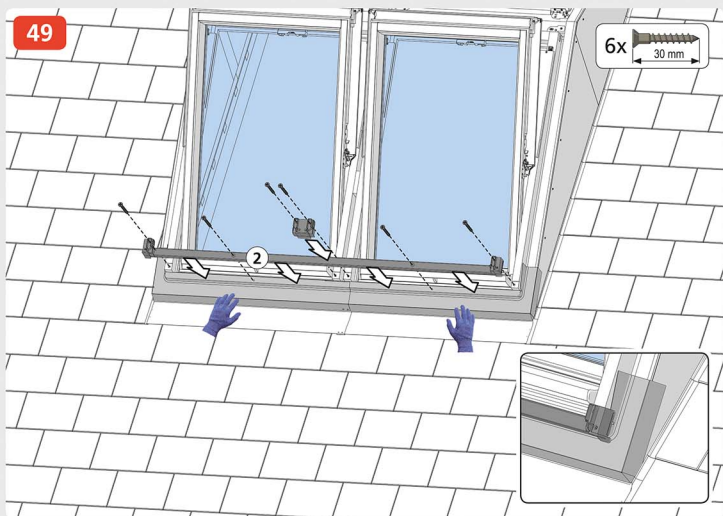



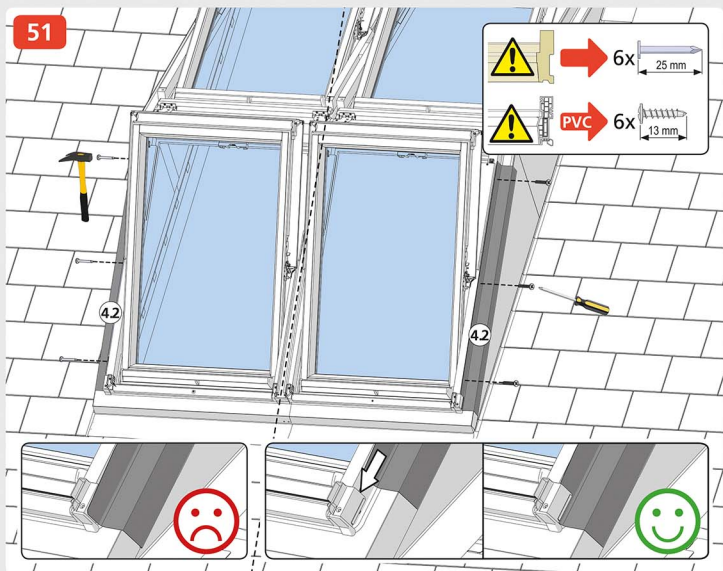
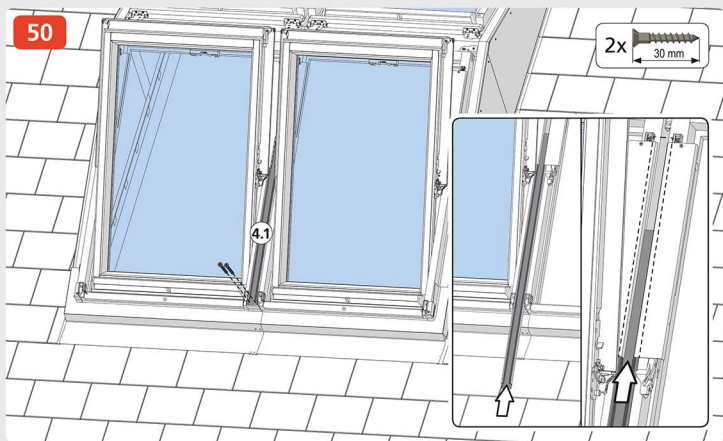

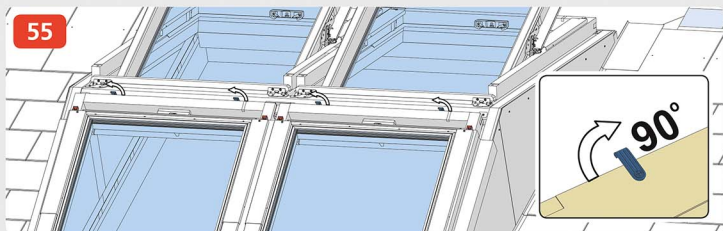
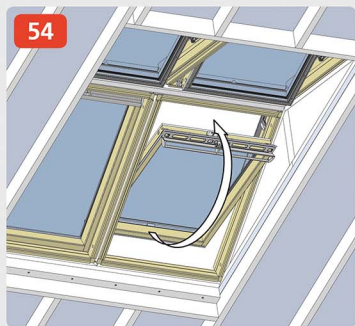
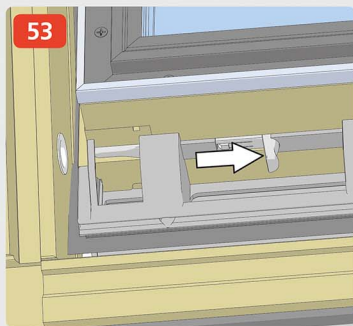

56a

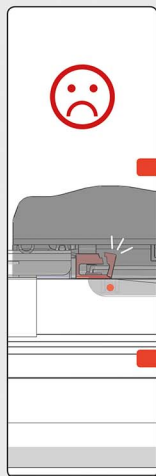
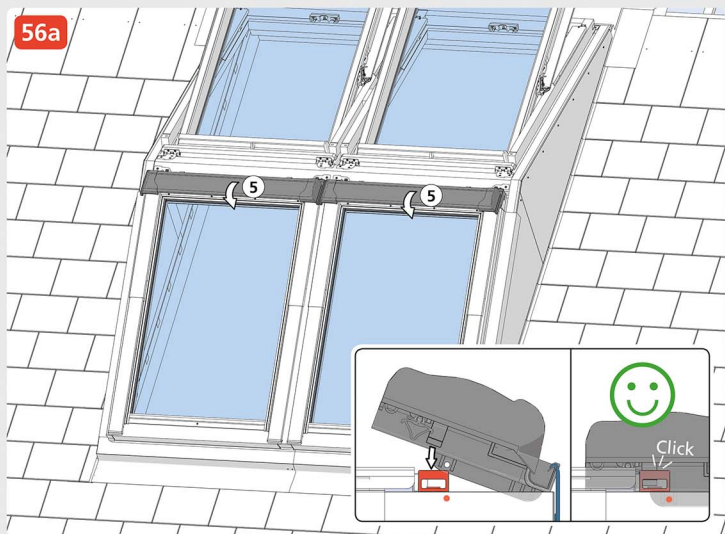

56b

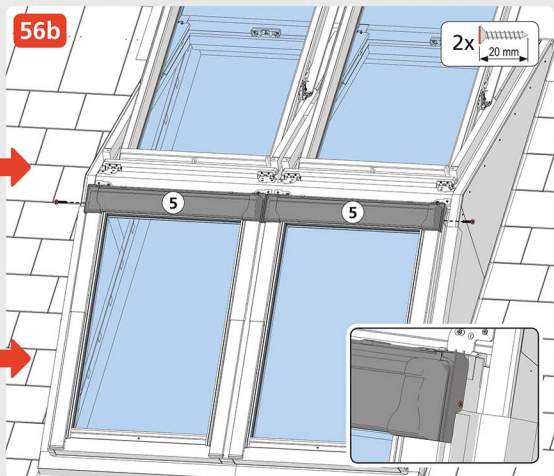

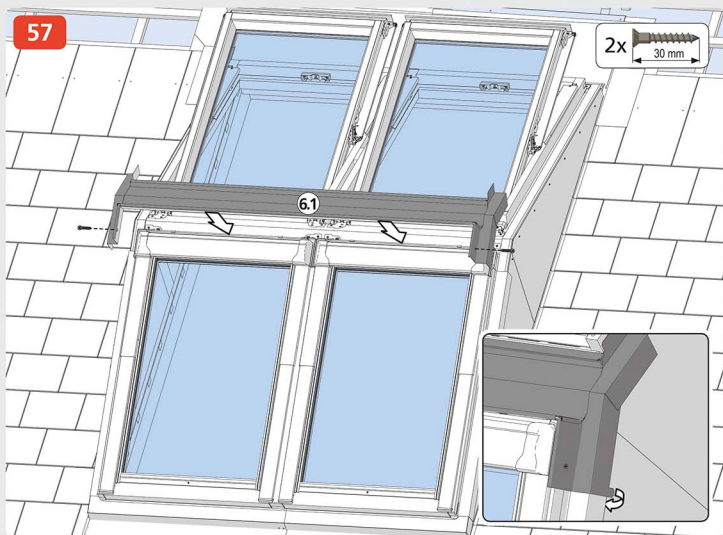

**49** ..... **56**

**20**

**23**

59

2x  30 mm

6

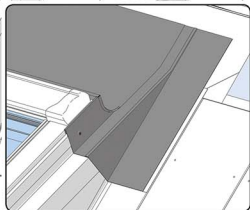

60

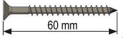
2x  60 mm

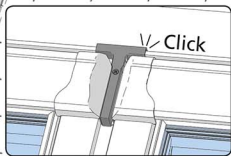

61

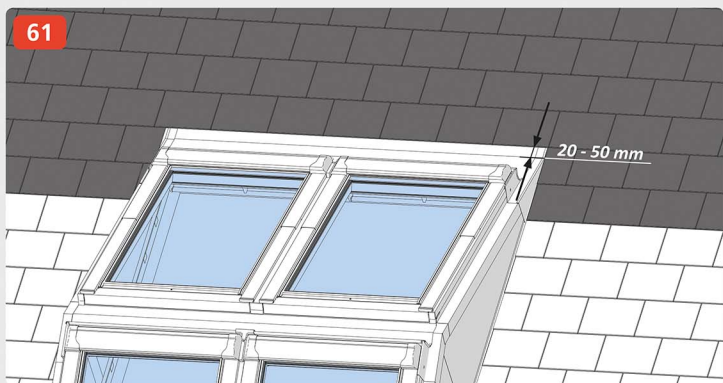

62

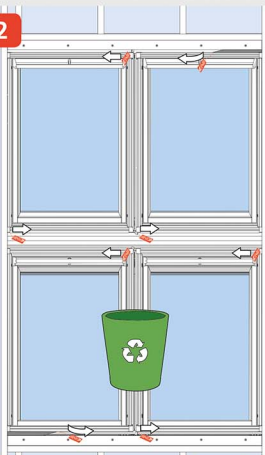

63

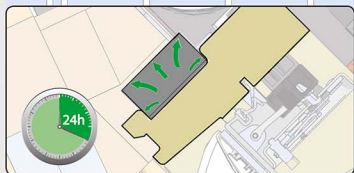
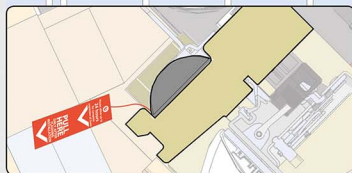
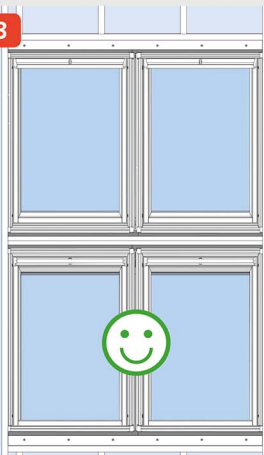



64

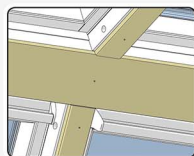
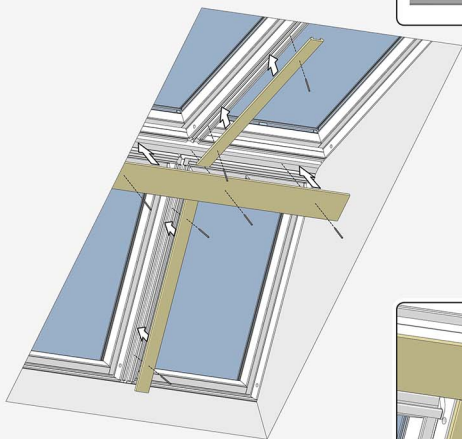

65

