

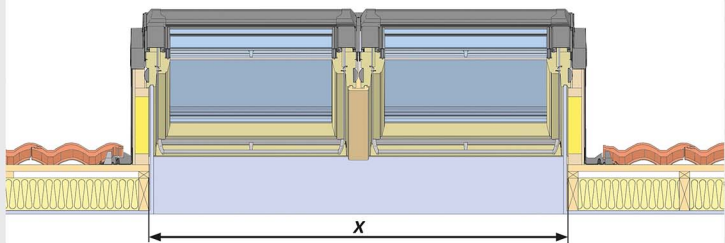

$Z = 120 - 140 \text{ mm}$

max 90 mm

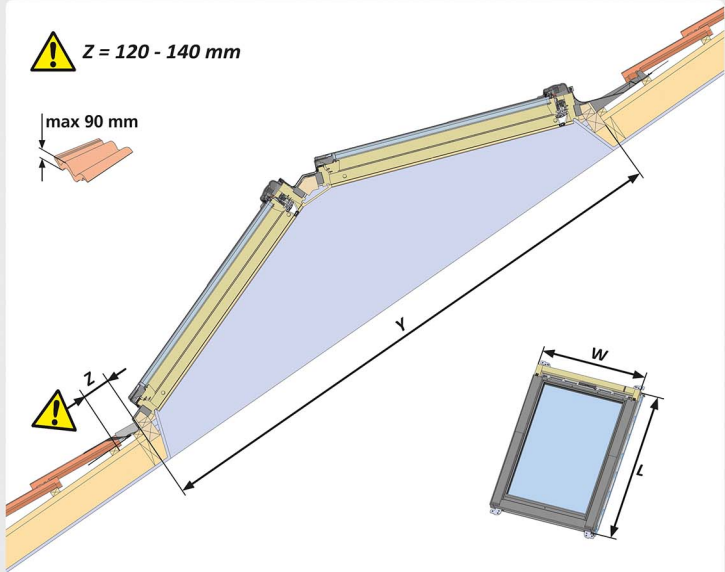

	X	Y
DRX4 04	1550 mm	2095 mm
DRX4 05	1550 mm	2470 mm
DRX4 07B	1870 mm	2095 mm
DRX4 07C	1870 mm	2470 mm
DRX4 08B	2270 mm	2095 mm
DRX4 08	2270 mm	2470 mm
DRX6 04	2350 mm	2095 mm
DRX6 05	2350 mm	2470 mm

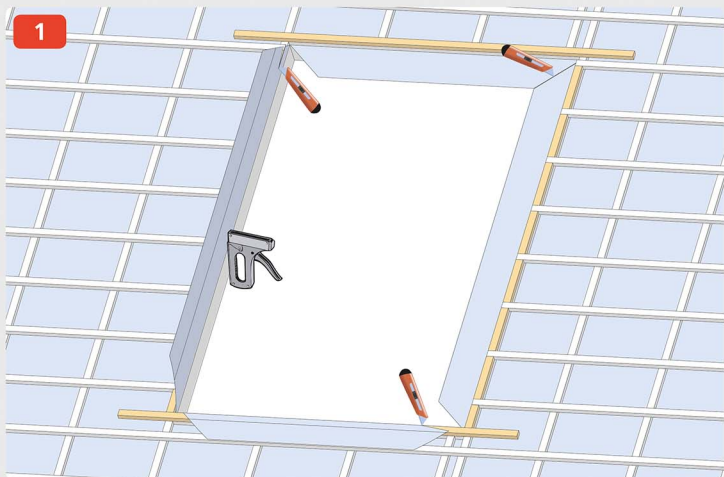
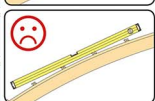
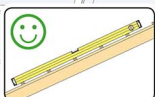
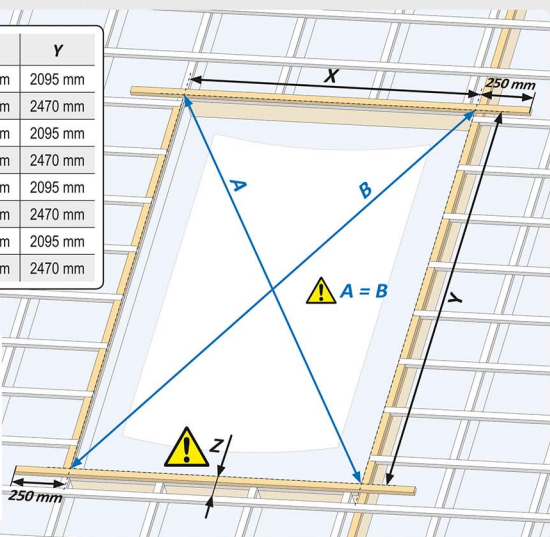

2

4x

90 mm

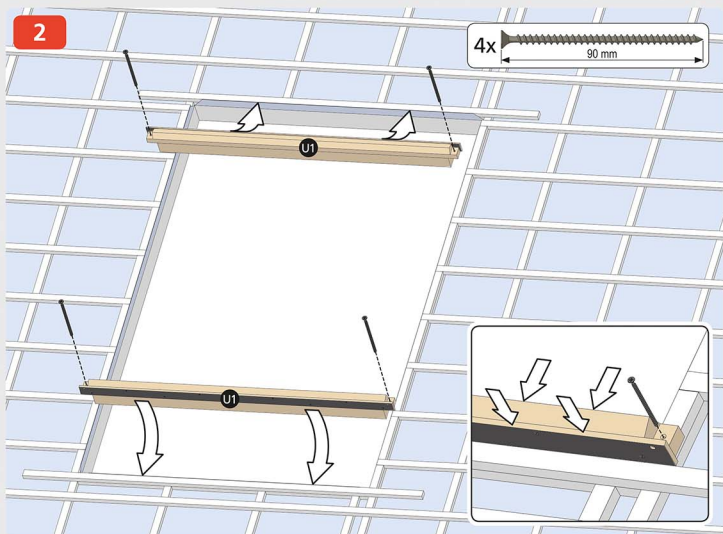

3

12x

70 mm

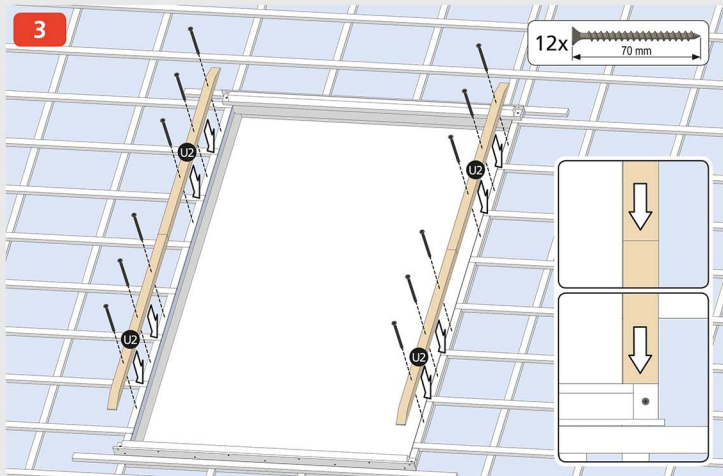

4

4

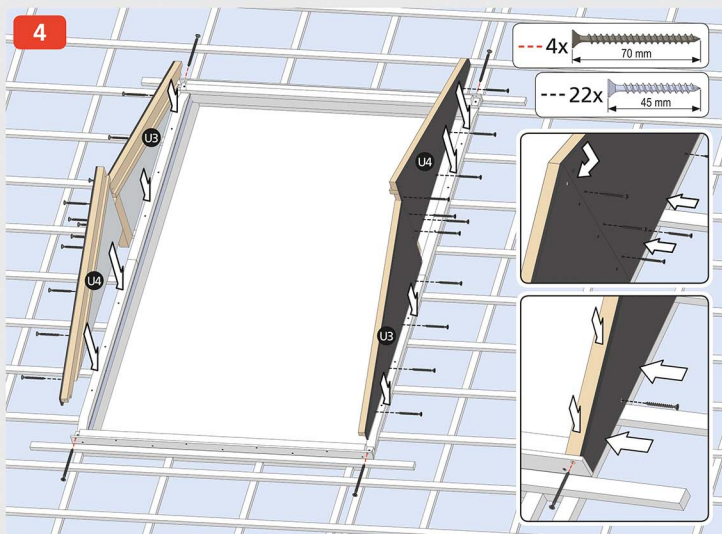

5

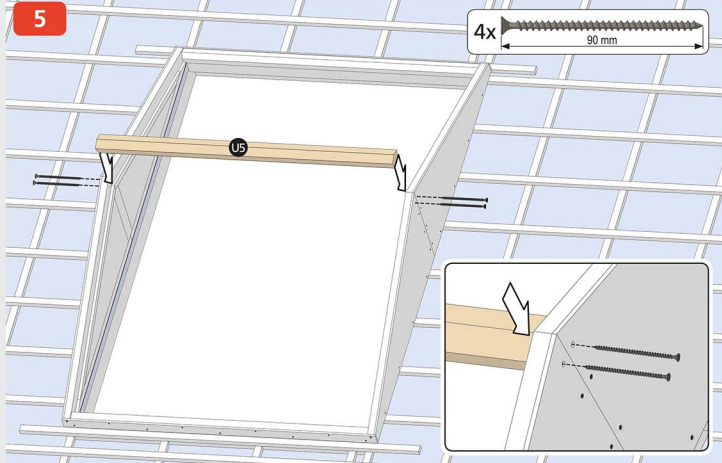

6

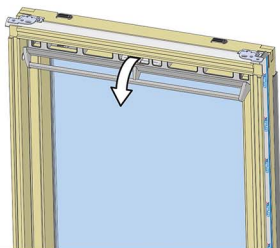

7

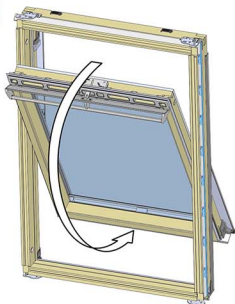

8

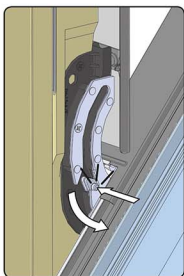

9

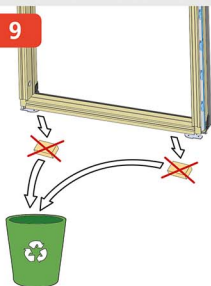

10

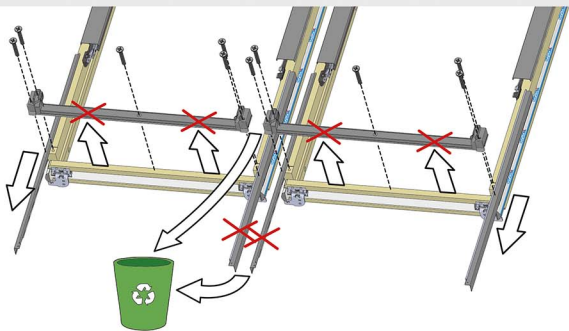

11

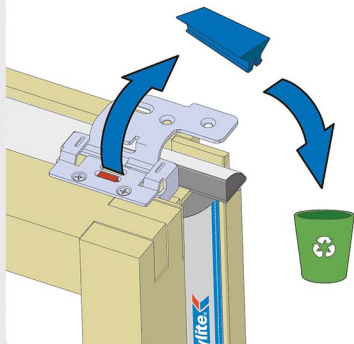

12

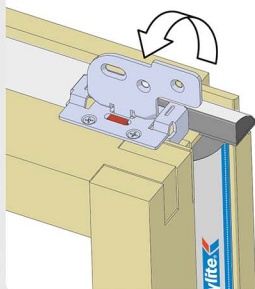

13

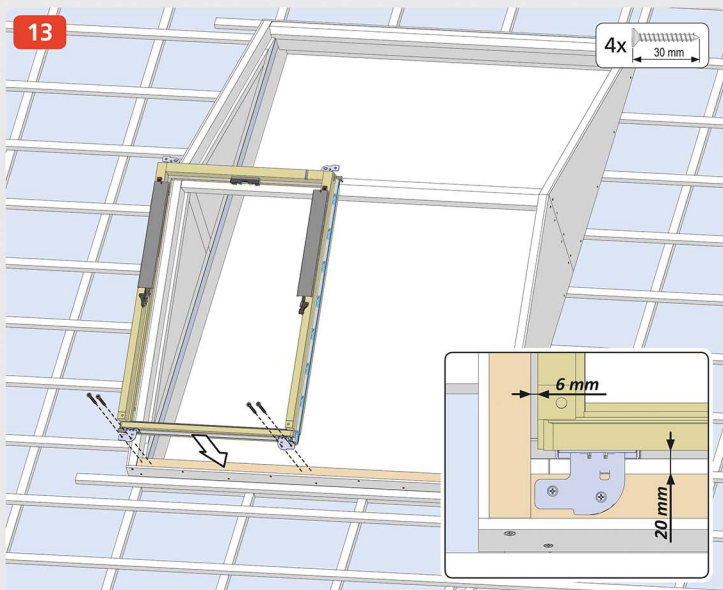

14

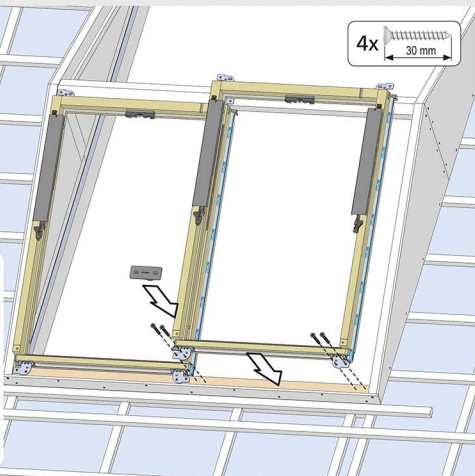
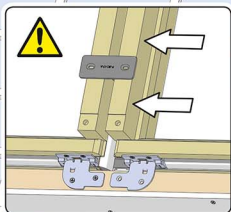
4x  30 mm

15

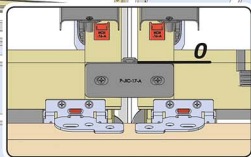
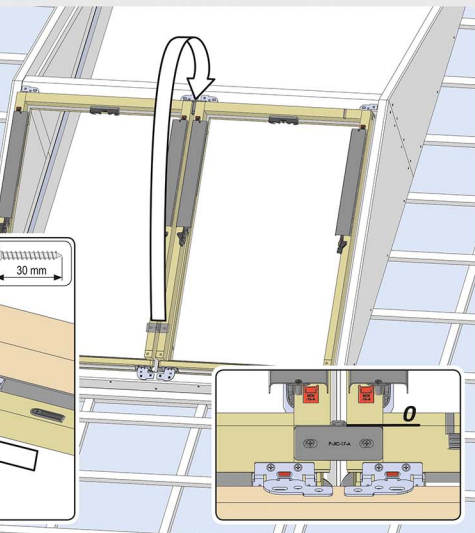
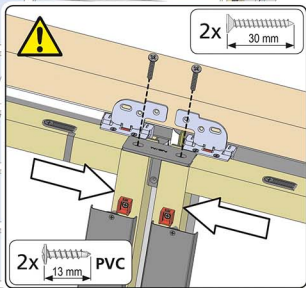
2x  30 mm

16

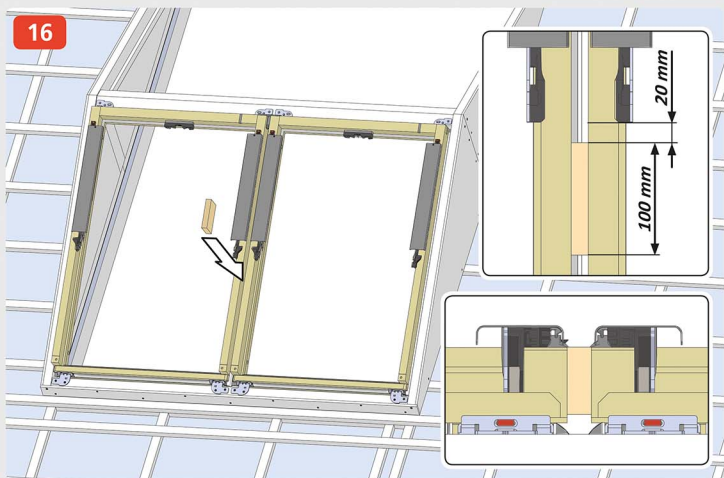

17

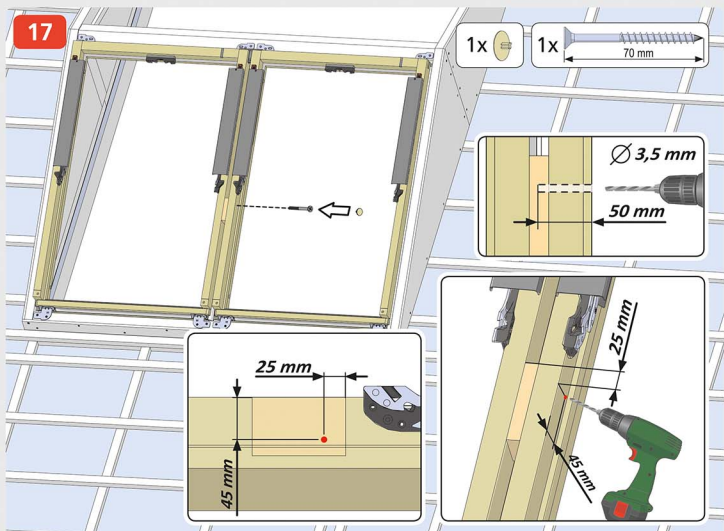

18

1x



1x



70 mm

 $\varnothing 3,5 \text{ mm}$

50 mm

25 mm

45 mm

25 mm

45 mm

19

6

18

6

10

20

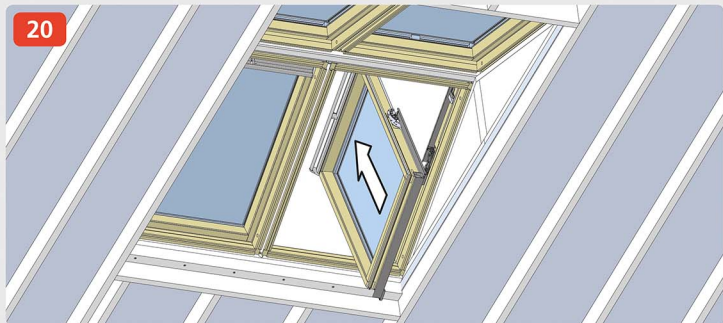

21

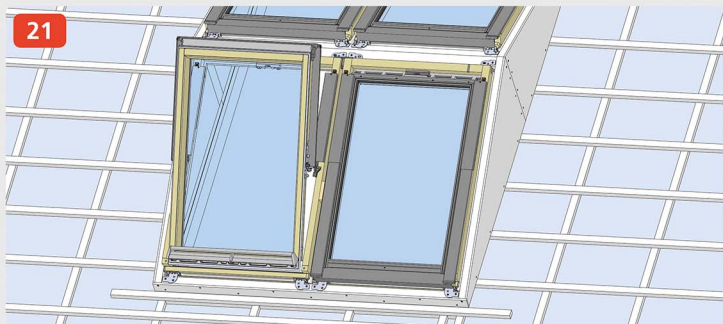

22

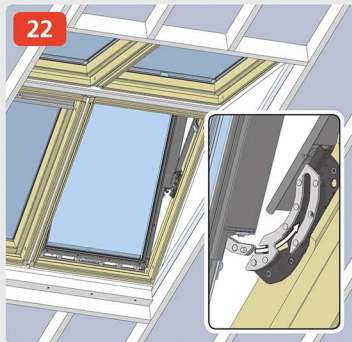

23

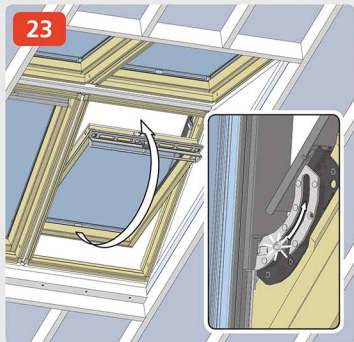

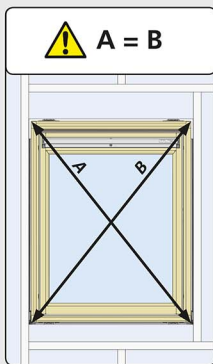
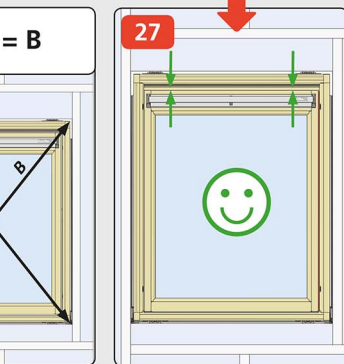
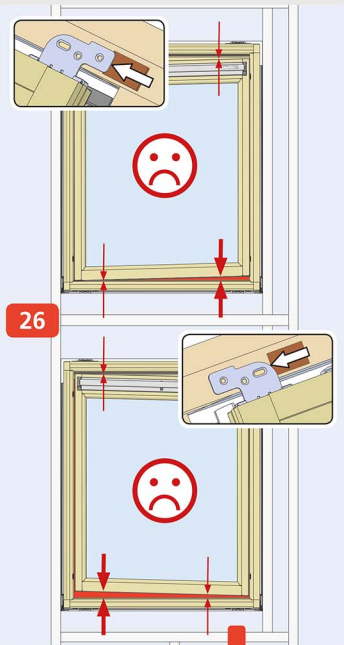
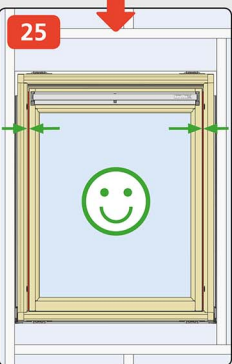
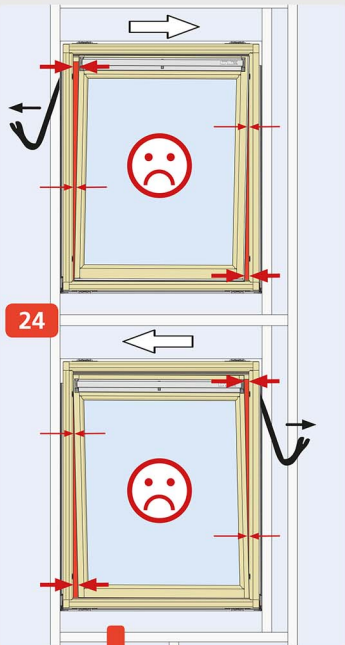

28

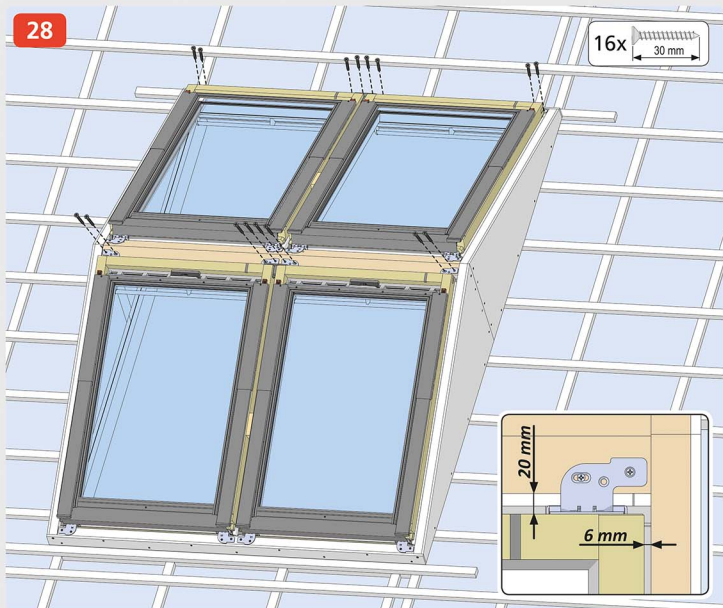
16x
30 mm

29

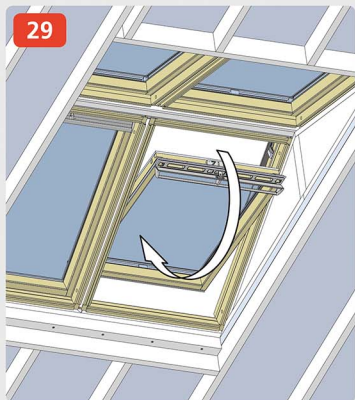

30

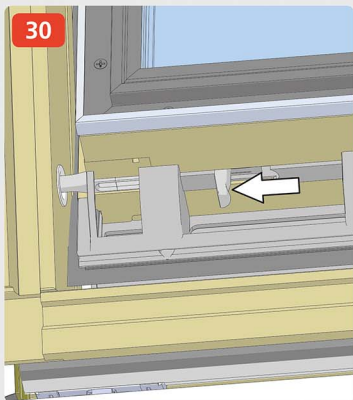

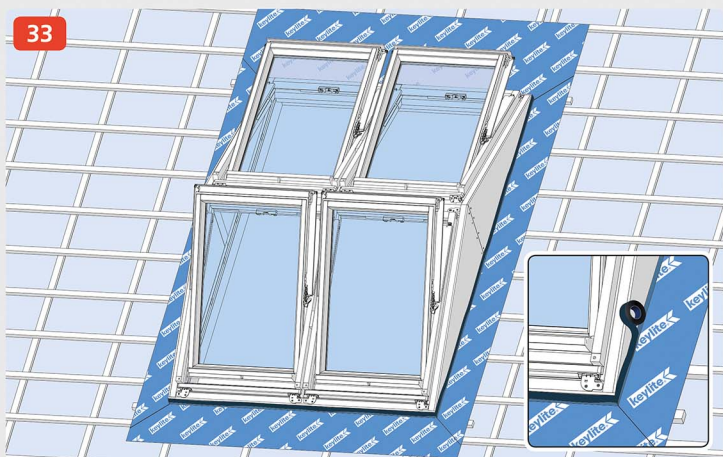
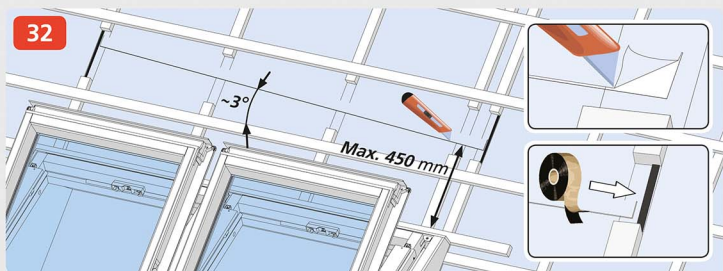
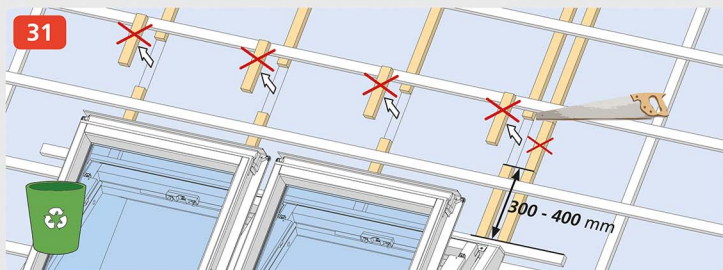

34

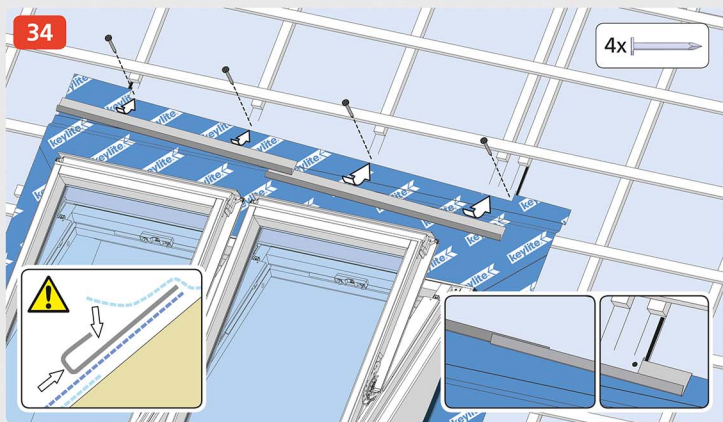
4x 

35

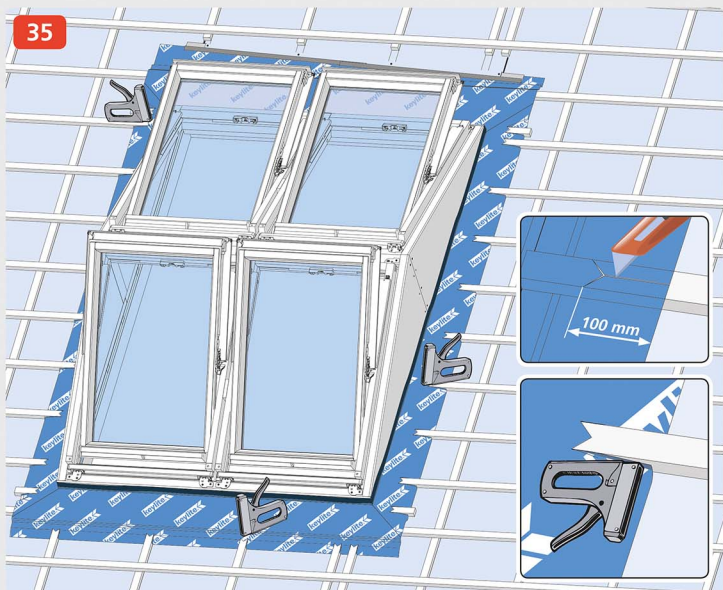

36

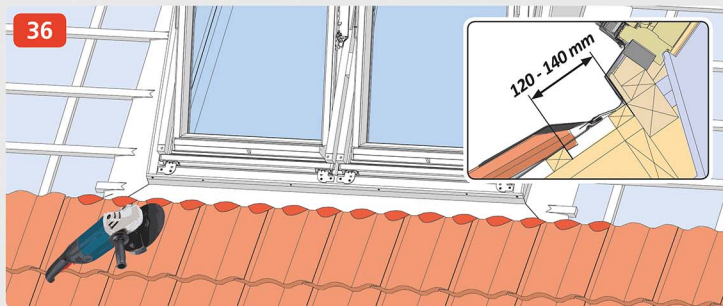

37

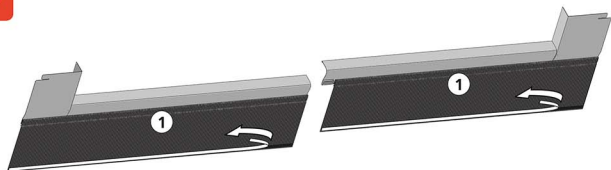

38

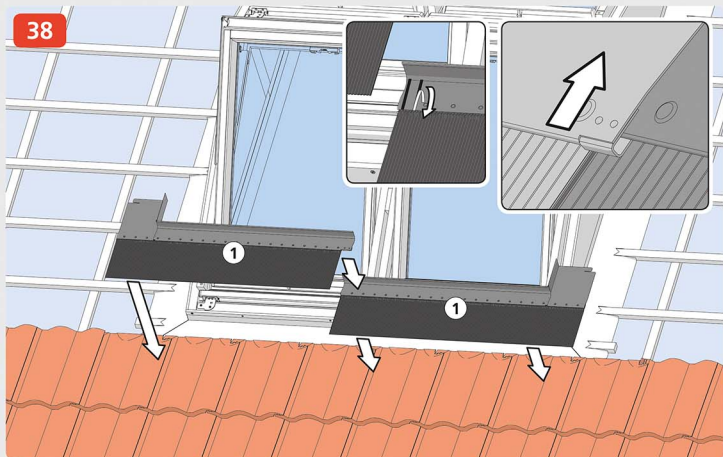

39

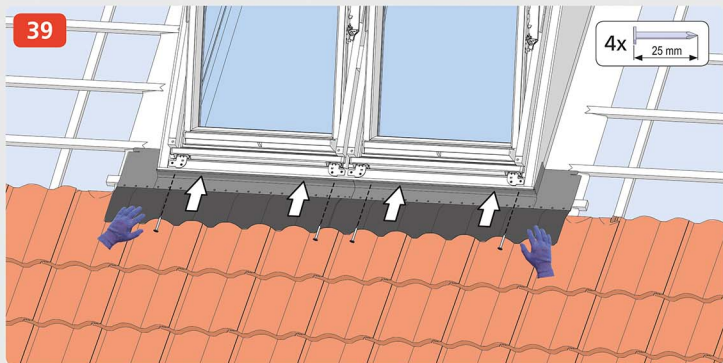
4x  25 mm

40

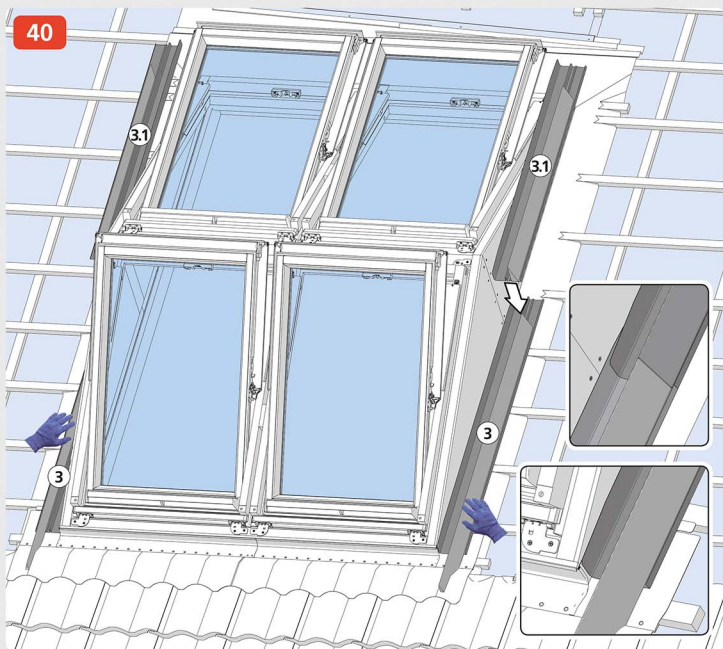

41

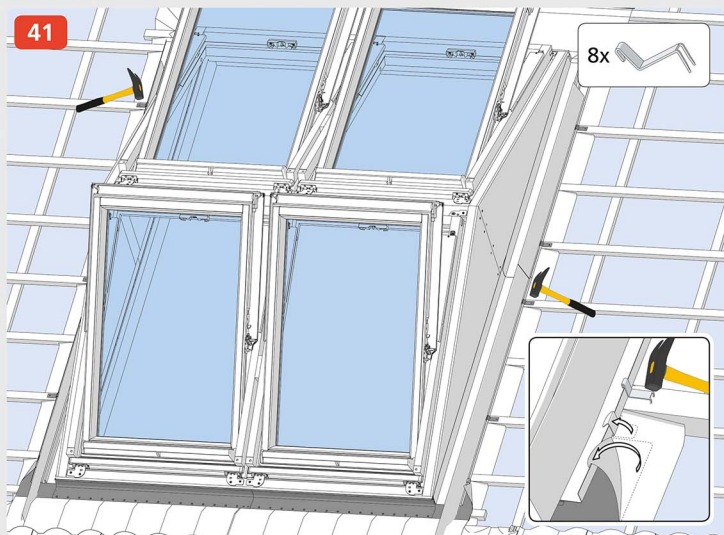

42

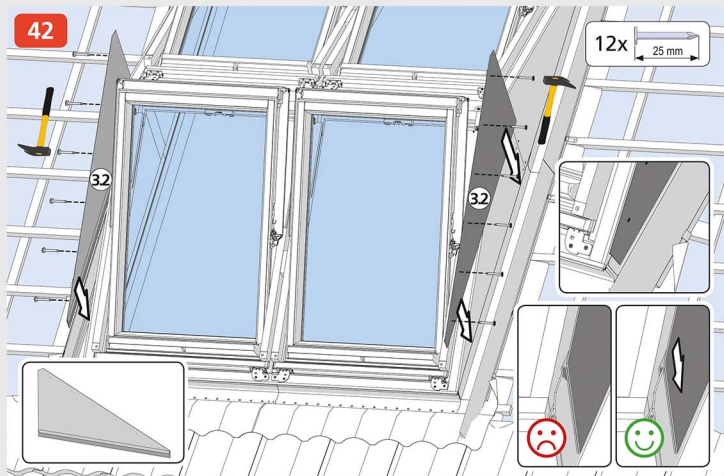

43

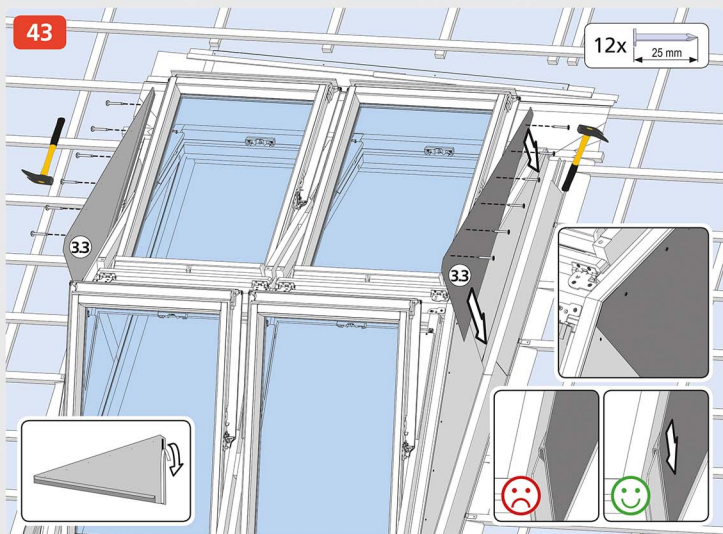
12x  25 mm

44

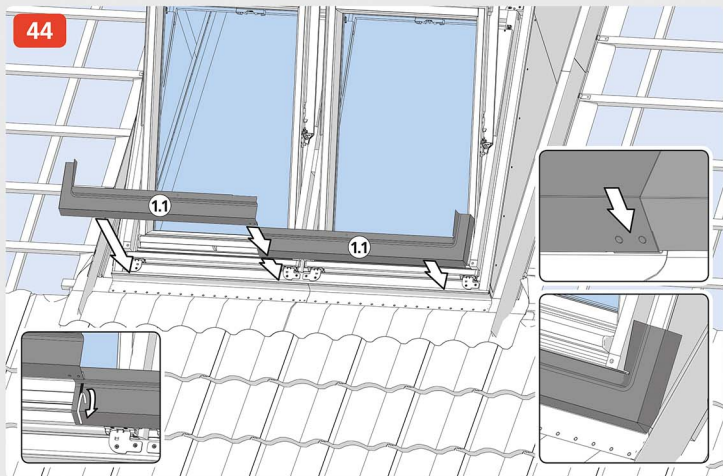

45

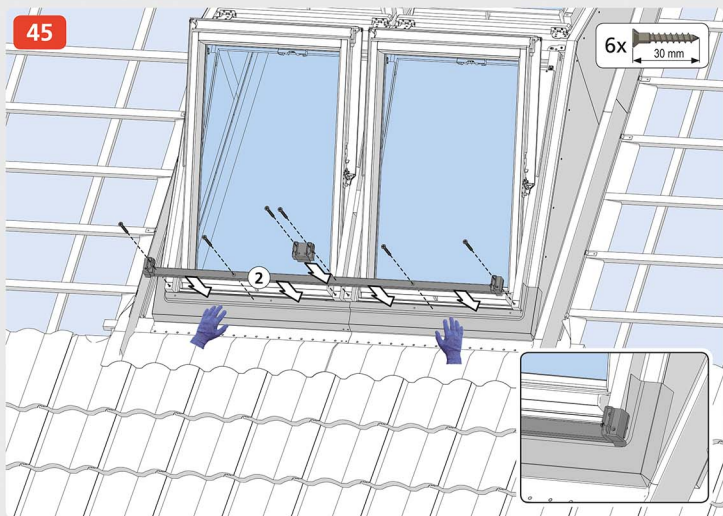

46

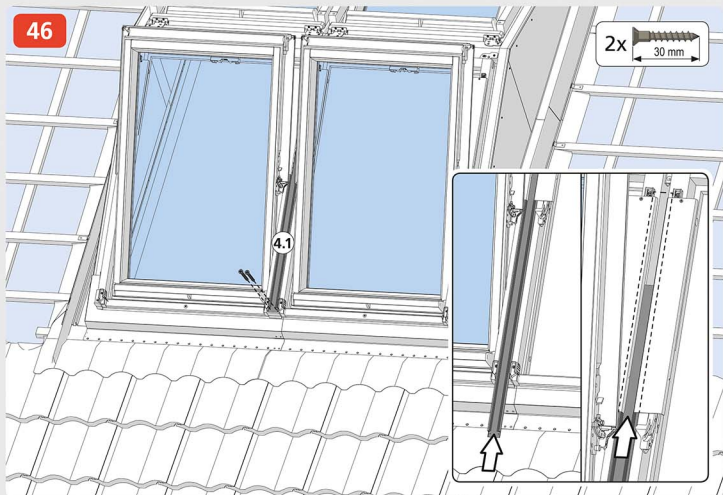

47

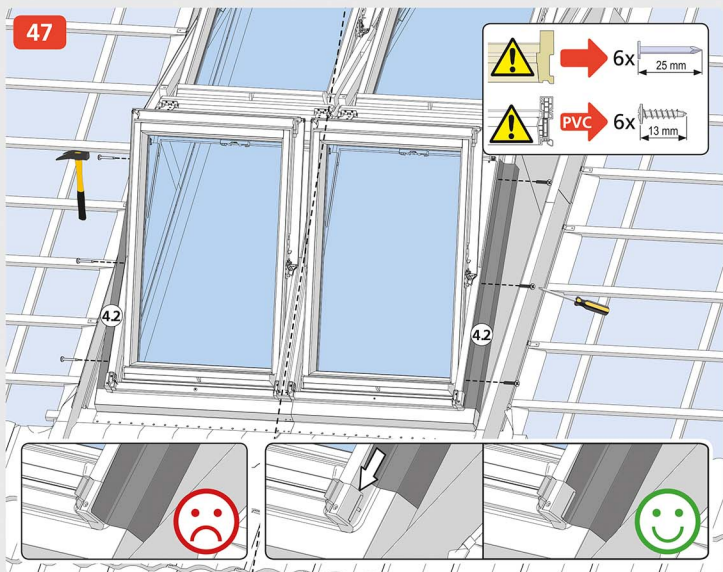

48

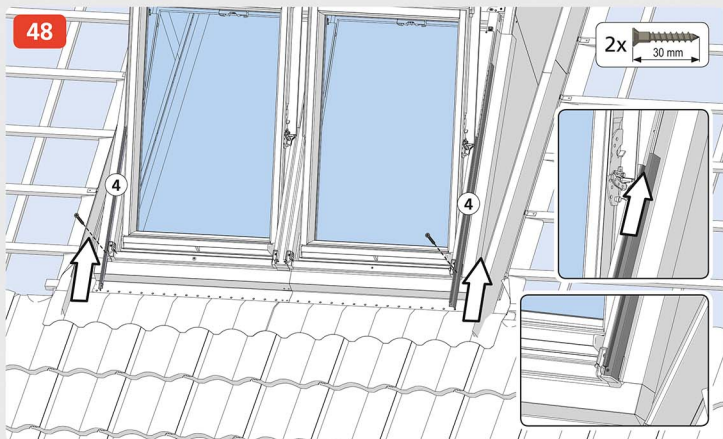

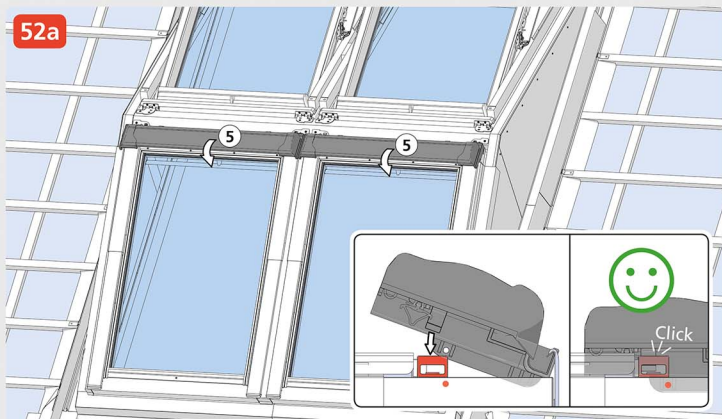
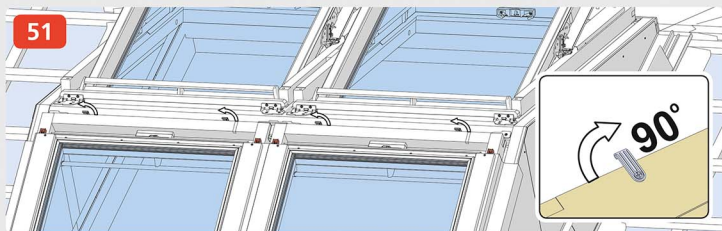
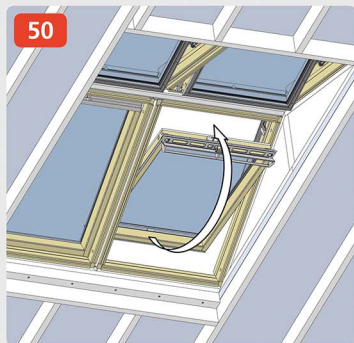
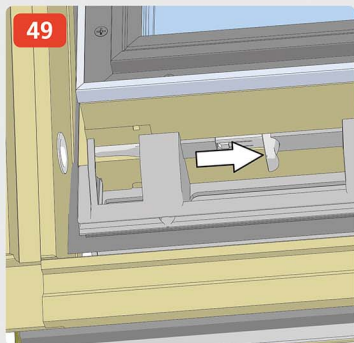

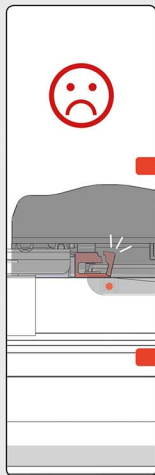

52b

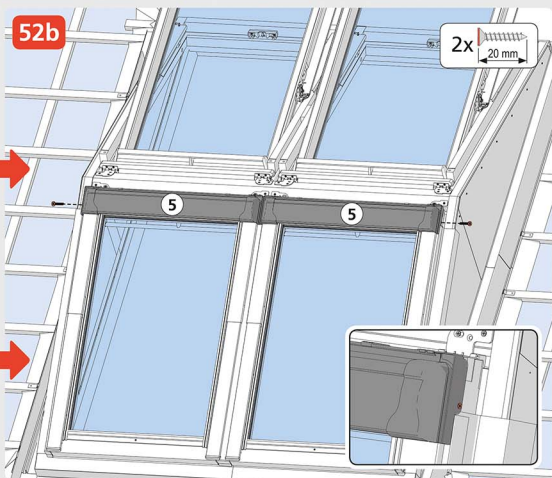

53

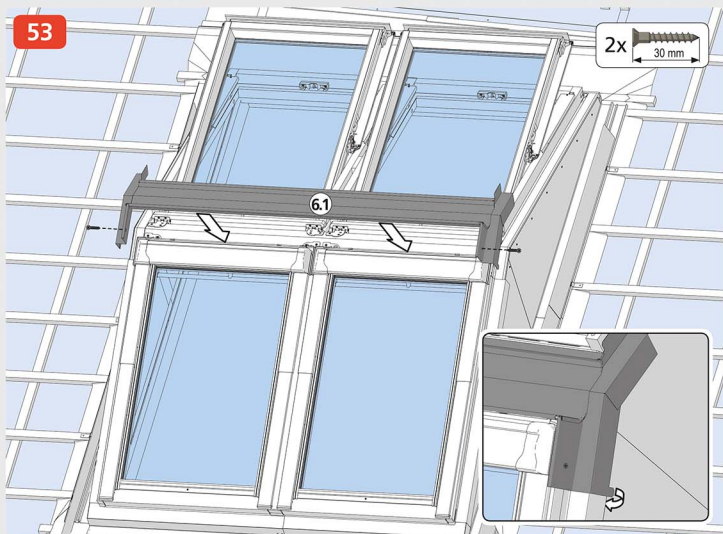

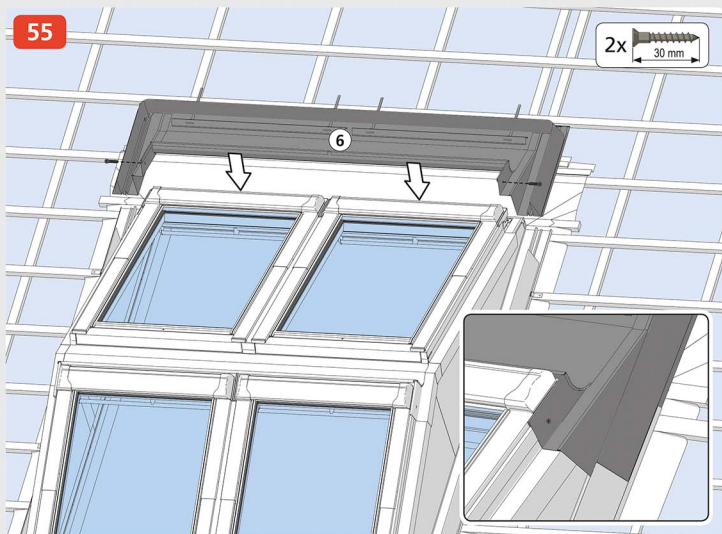
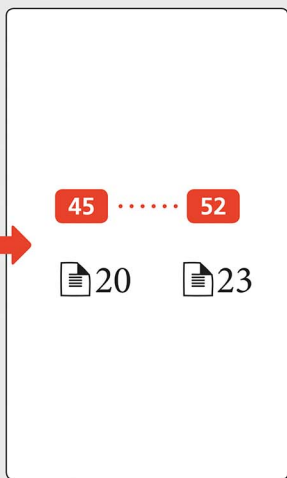
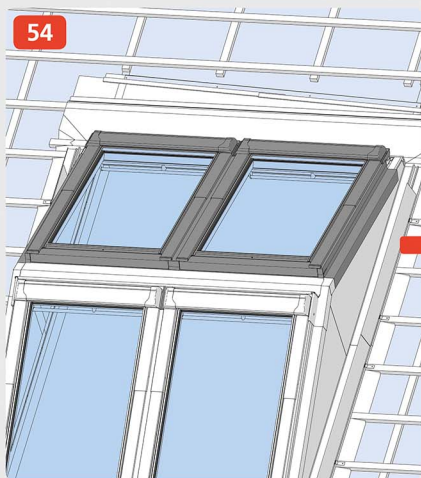

56

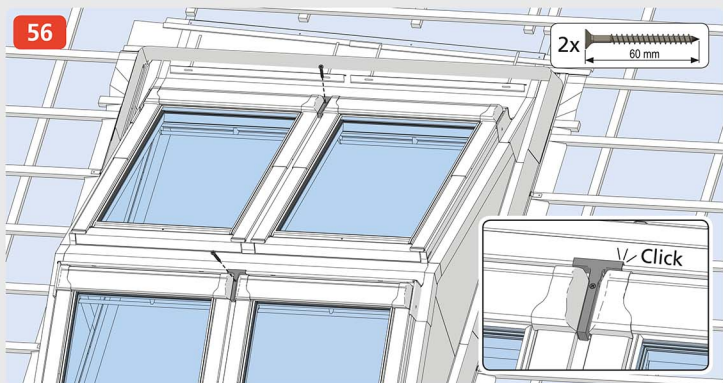

57

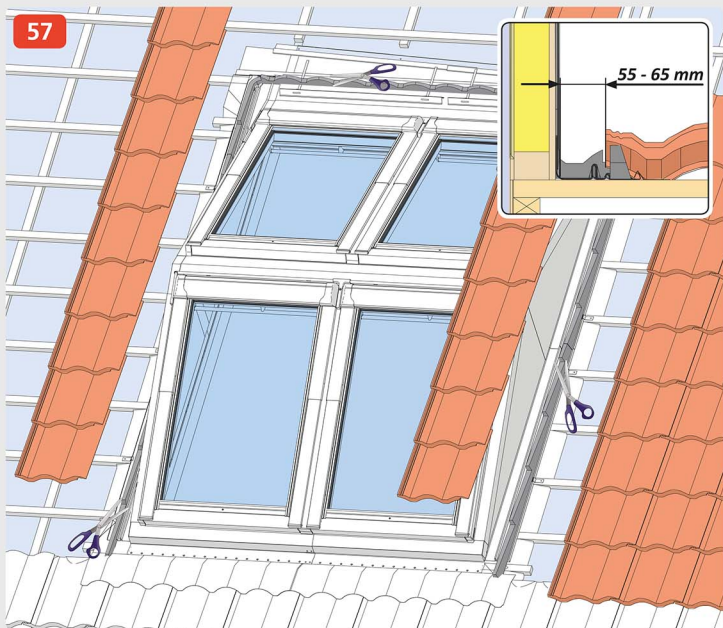

58

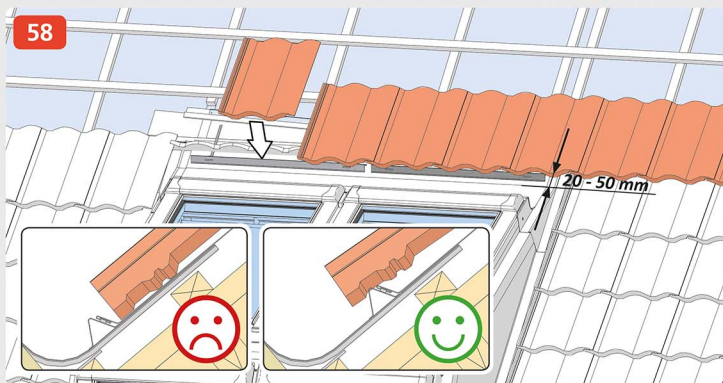

59

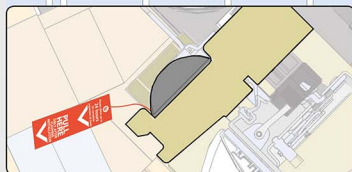

60

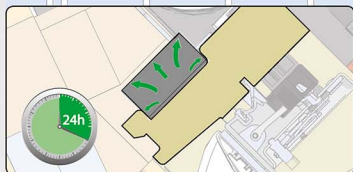
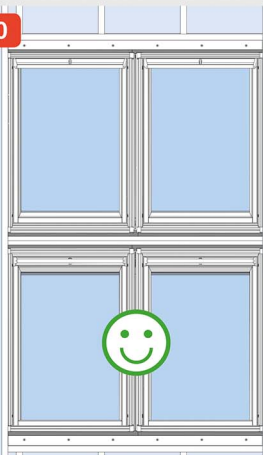

61

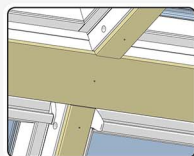
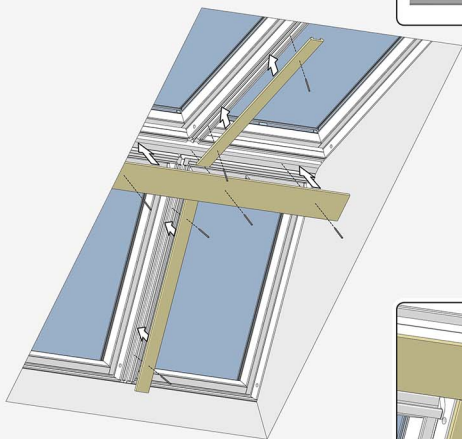

62

