

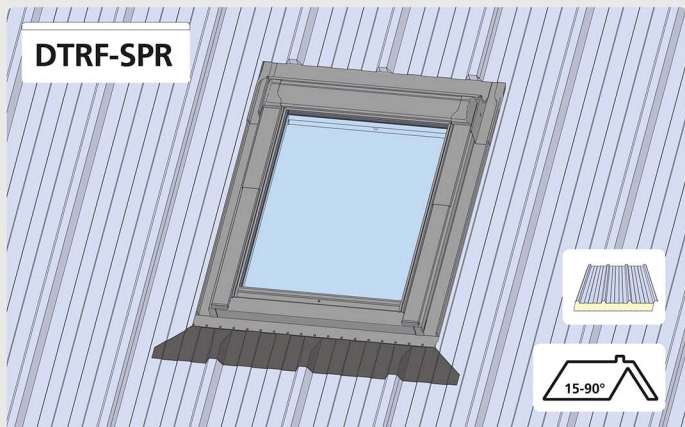

DTRF-SPR

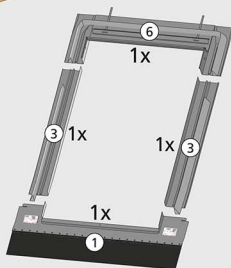

Deep Tile Roof Flashing - Sandwich Panel Roof

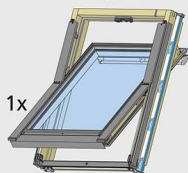

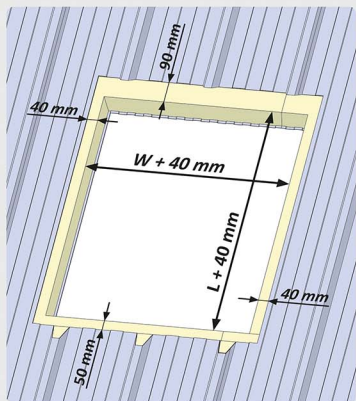
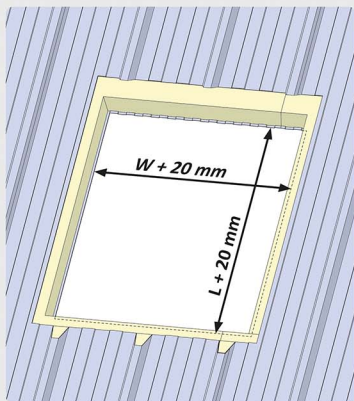
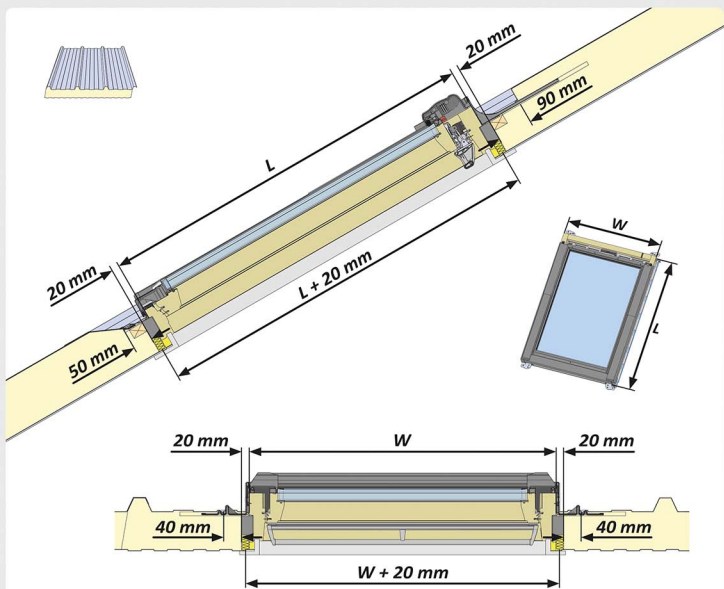

1

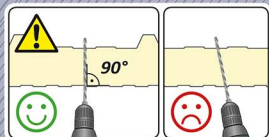
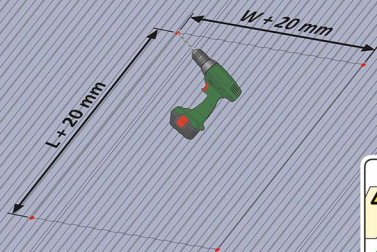

2

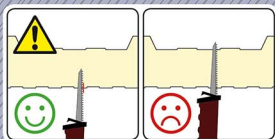
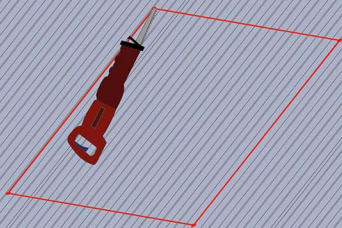

3

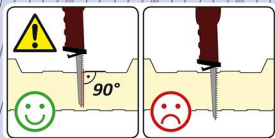
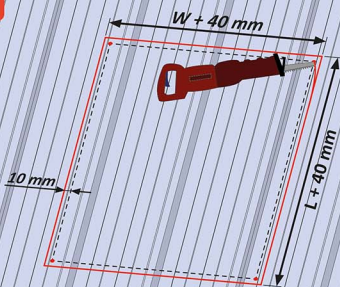

4

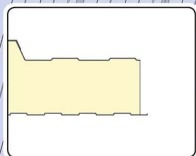

5

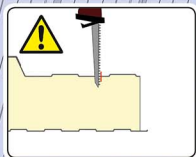
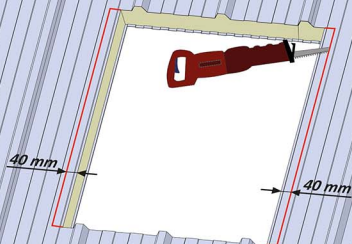

6

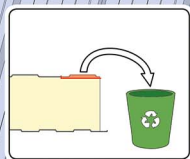
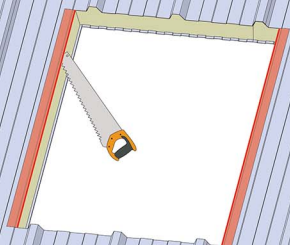

7

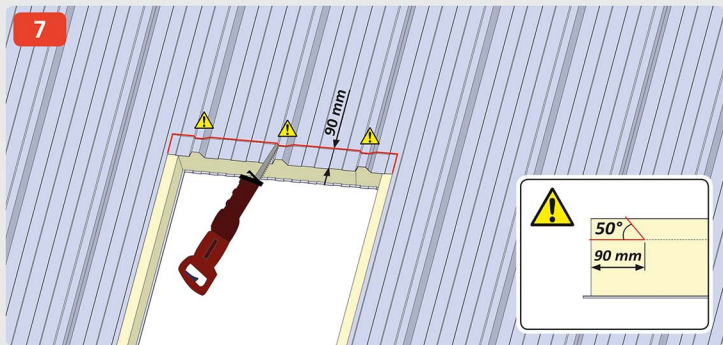

8

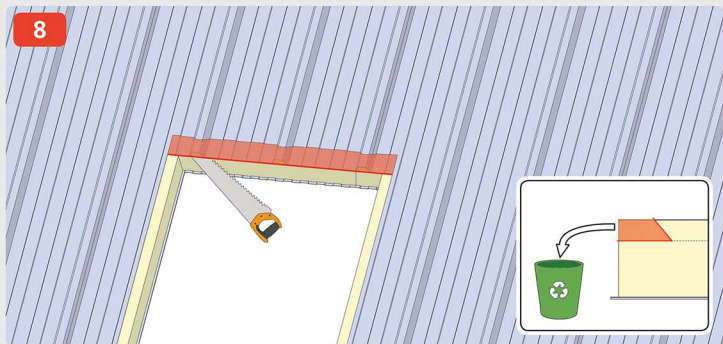

9

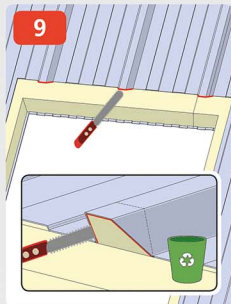

10

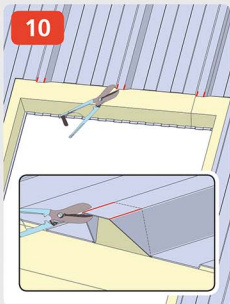

11

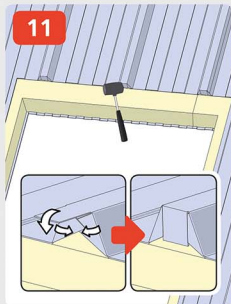

12

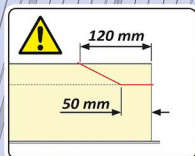
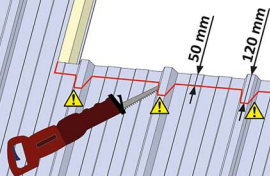

13

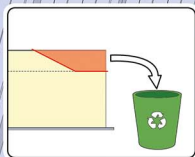
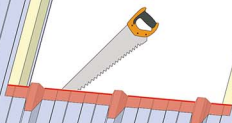

14

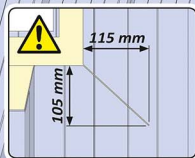
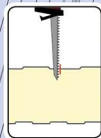
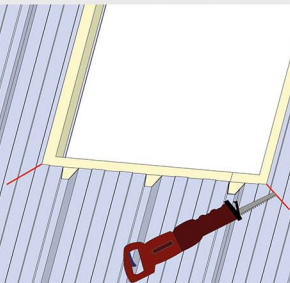

15

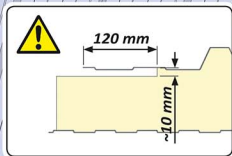
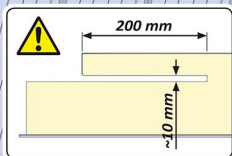
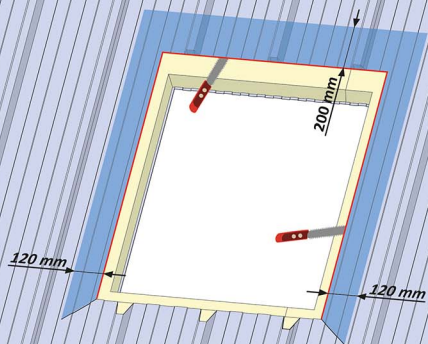

16

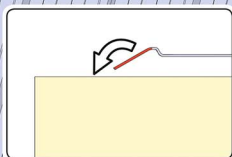
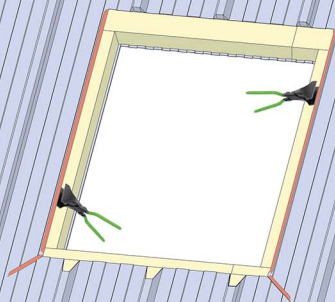

17

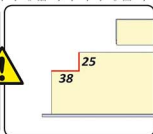
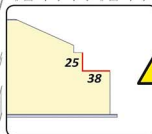
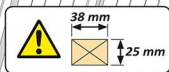
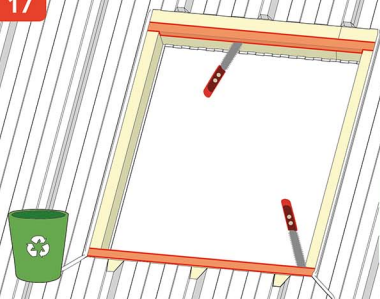

18

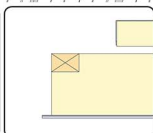
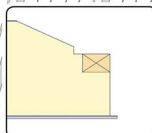
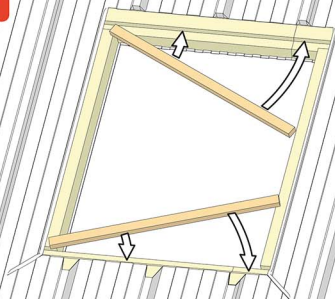

19

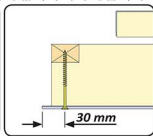
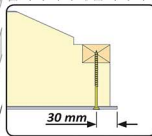
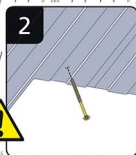
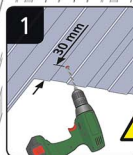
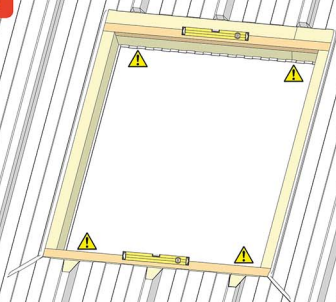

20

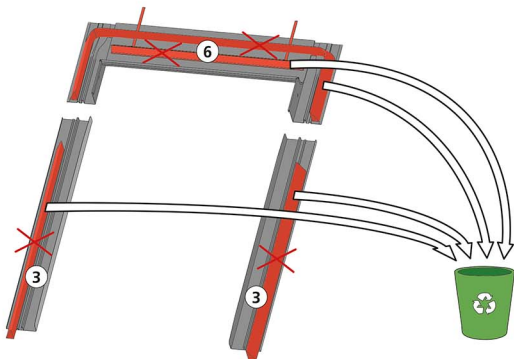

21

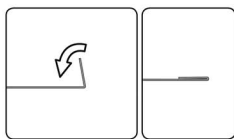
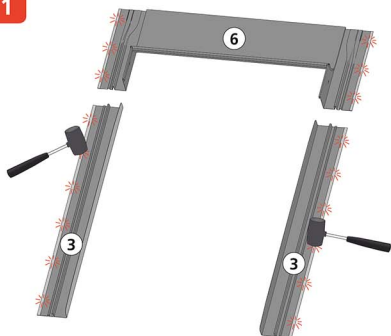

22

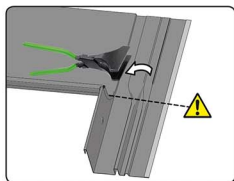
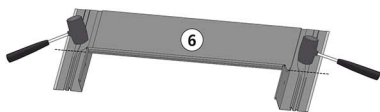

23

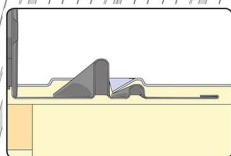
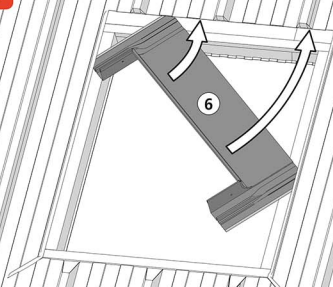

24

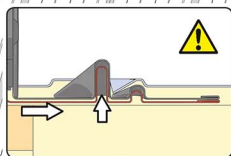
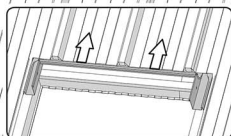
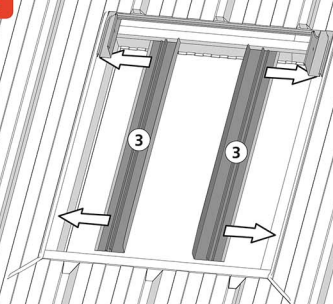

25a

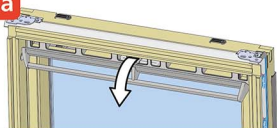

25b

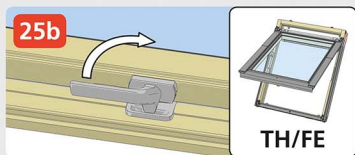

TH/FE

26

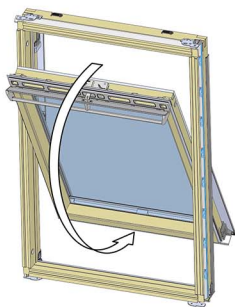

27

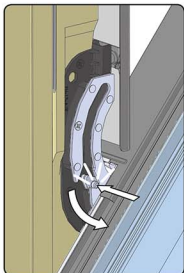

28

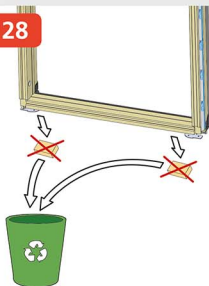

29

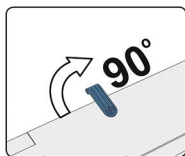
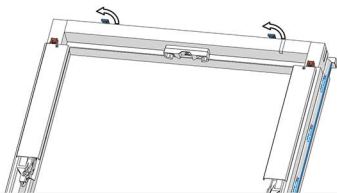

30a

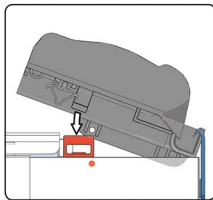

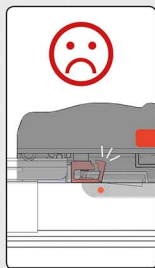

30b

2x  20 mm

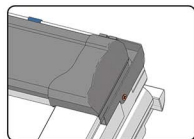
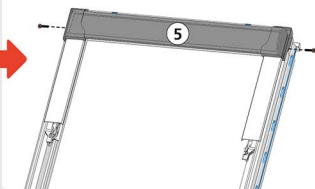

31

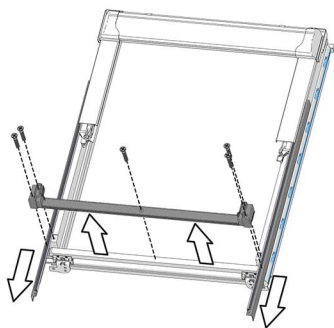

32

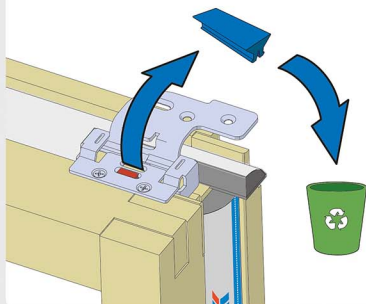

33

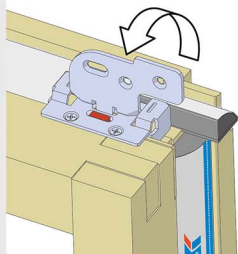

34

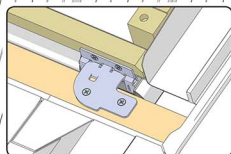
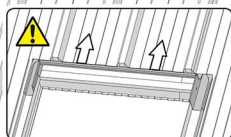
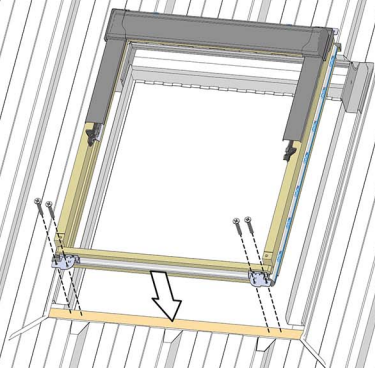
4x  30 mm

35

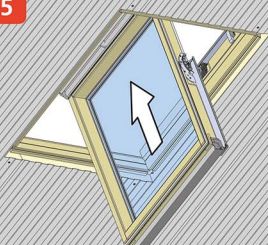

36

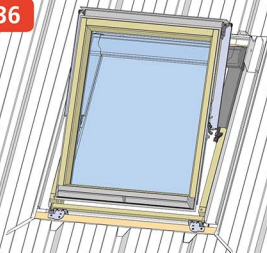

37

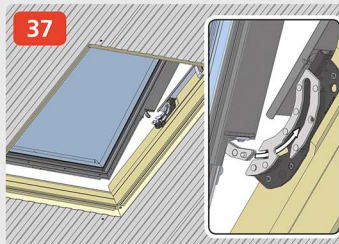

38

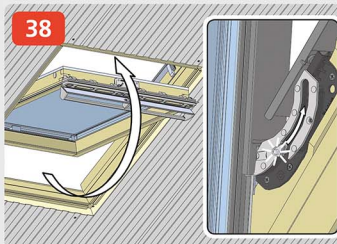

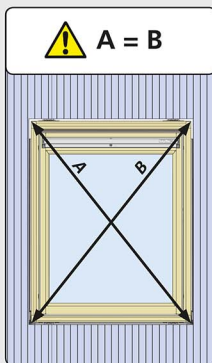
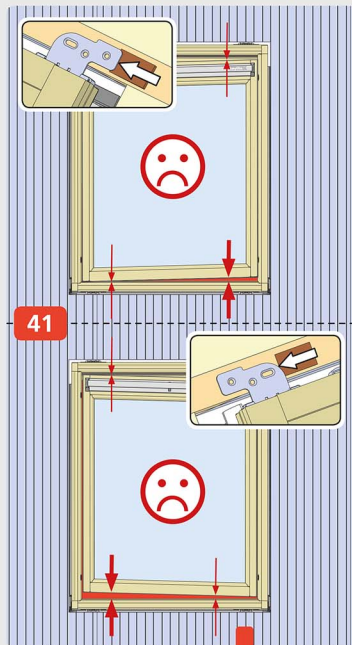
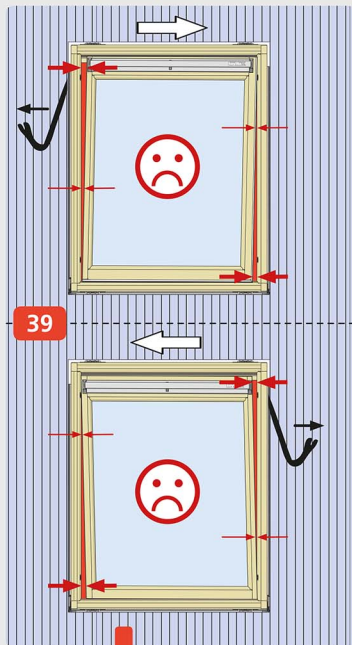

43

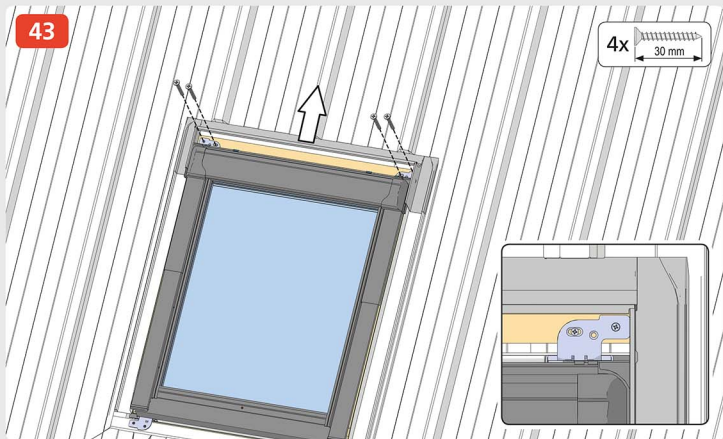
4x
30 mm

44

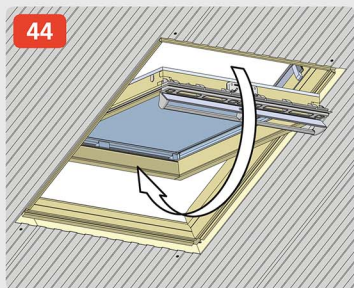

45

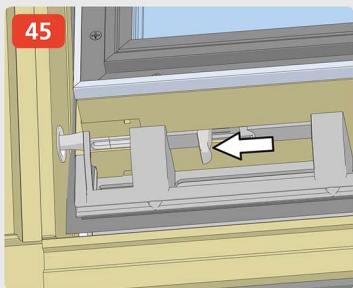

46

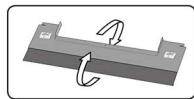
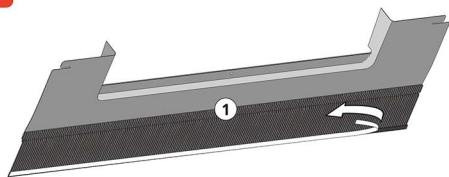

47

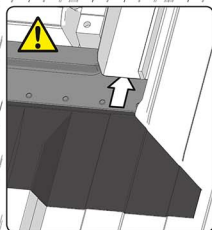
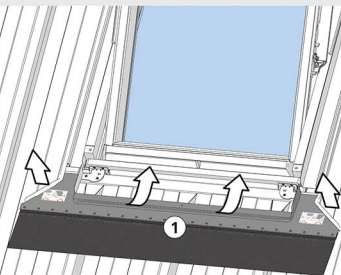

48

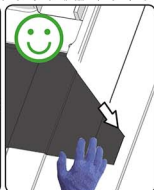
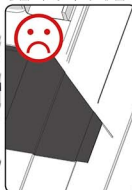

49

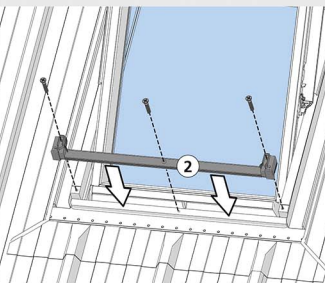

3x  30 mm

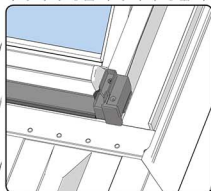

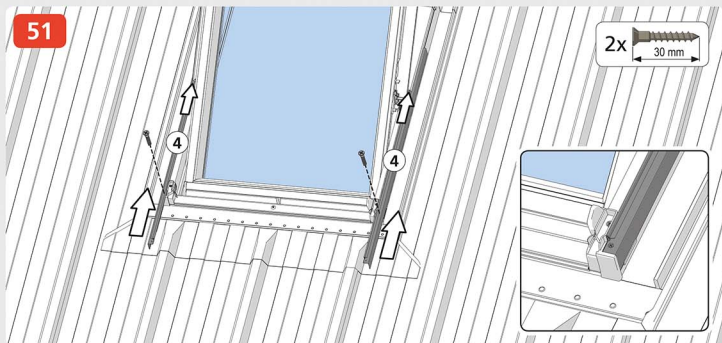
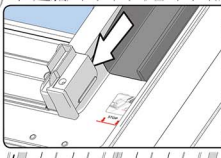
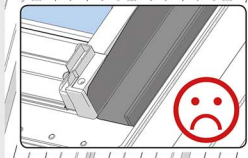
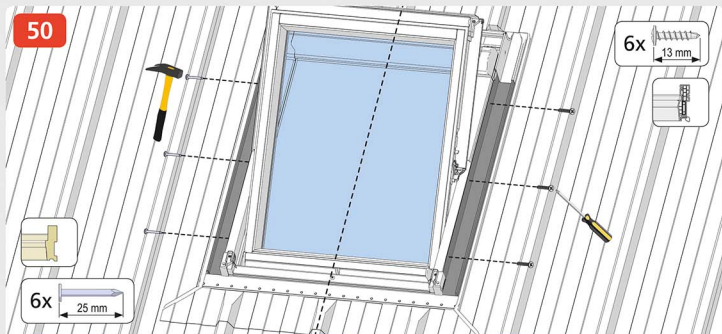
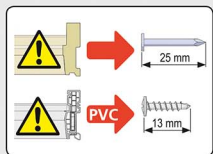

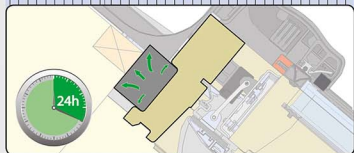
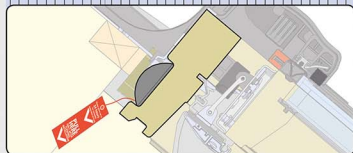
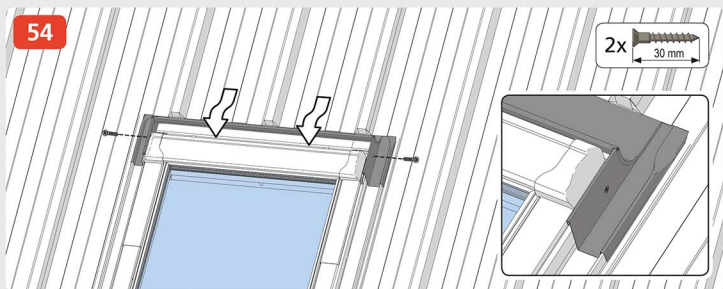
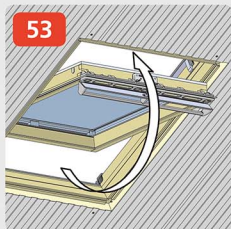
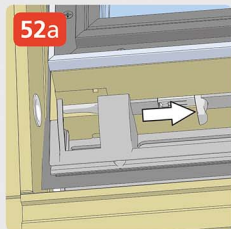

$K < 60 \text{ mm}$

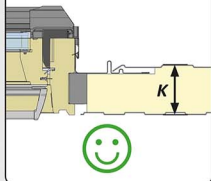

57

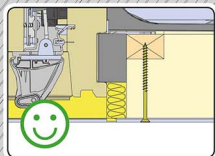
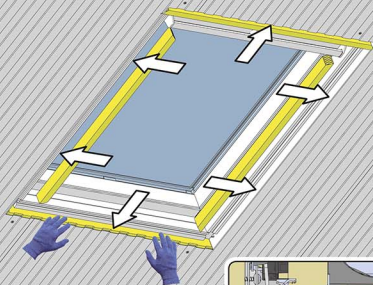
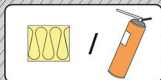

$K > 60 \text{ mm}$

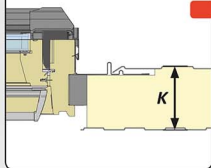

58

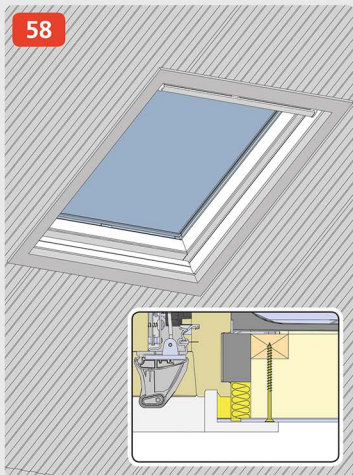

59

