

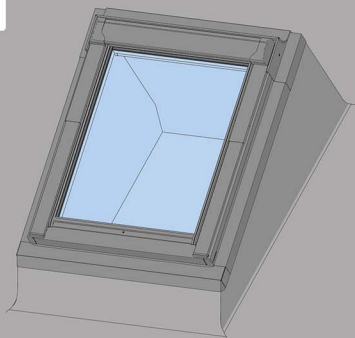

FRS

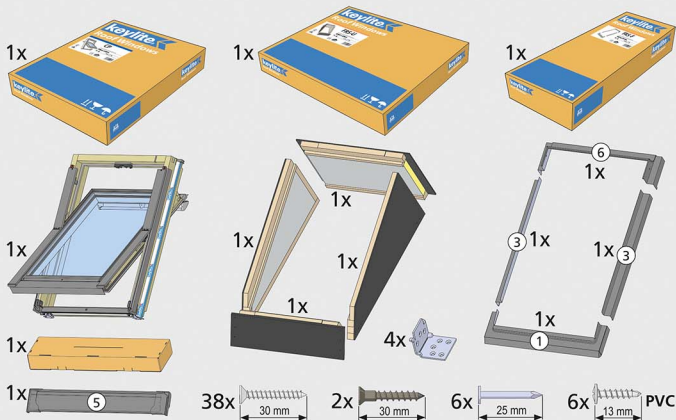

Flat Roof System



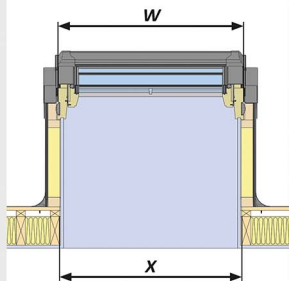
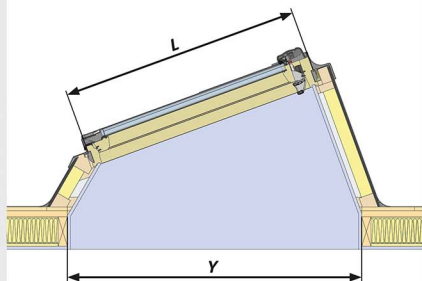

0-15°

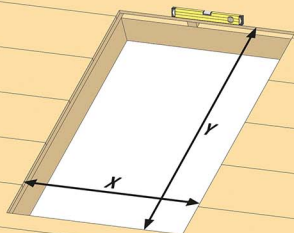
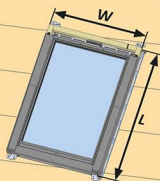

	W x L	X x Y
FRS 01	550 x 780	530 x 1000
FRS 02	550 x 980	530 x 1200
FRS 01C	550 x 1180	530 x 1400
FRS 03	660 x 1180	640 x 1400
FRS 04	780 x 980	760 x 1200
FRS 05	780 x 1180	760 x 1400
FRS 06	780 x 1400	760 x 1620
FRS 07F	940 x 1400	920 x 1620
FRS 07	940 x 1600	920 x 1820
FRS 08	1140 x 1180	1120 x 1400
FRS 09	1340 x 980	1320 x 1200
FRS 10	1340 x 1400	1320 x 1620
FRS ZZ	X = W - 20 mm , Y = L + 220 mm	

1

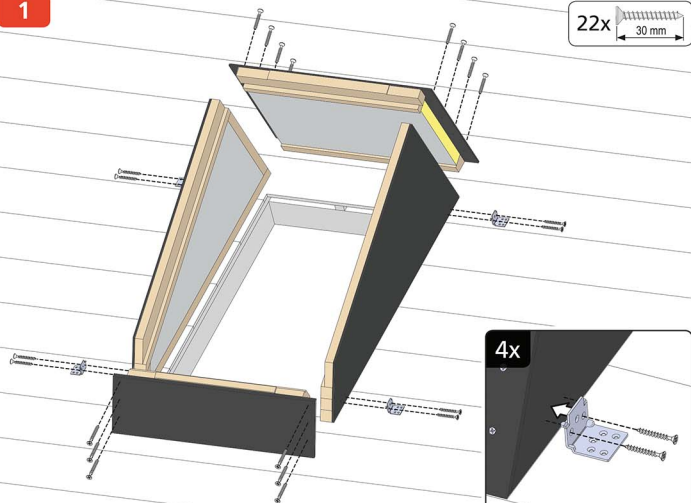

2

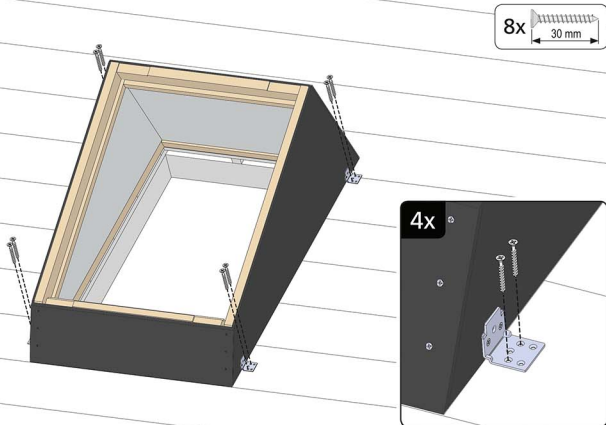

3

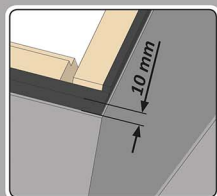
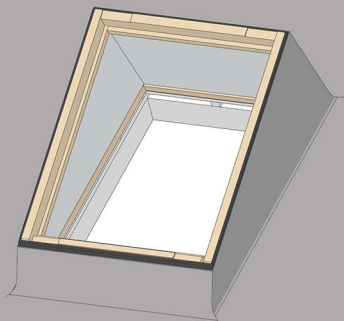

4

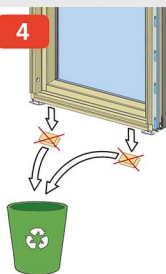

5

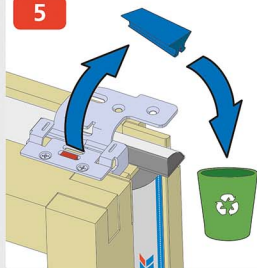

6

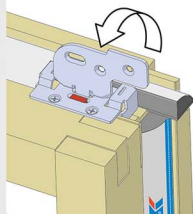

7

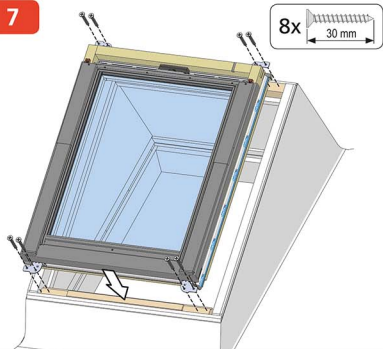

8

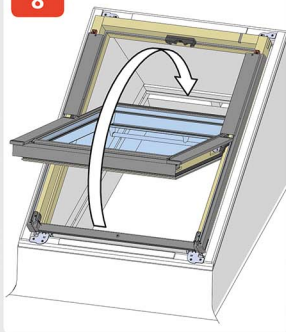

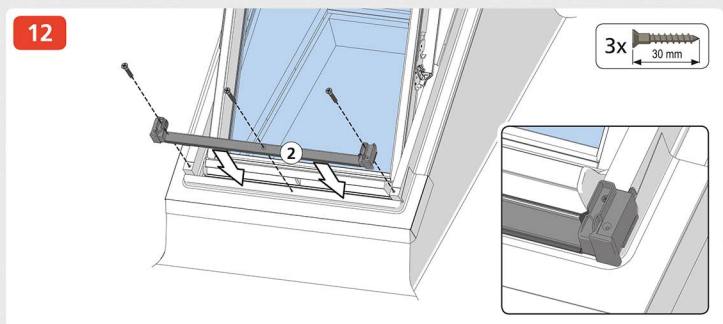
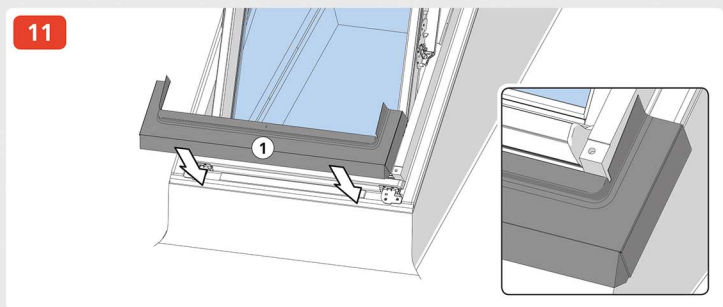
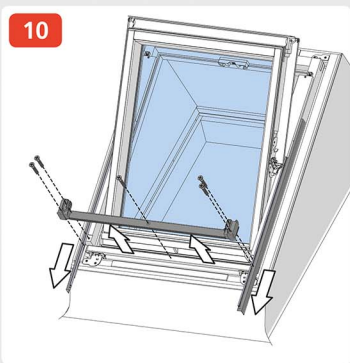
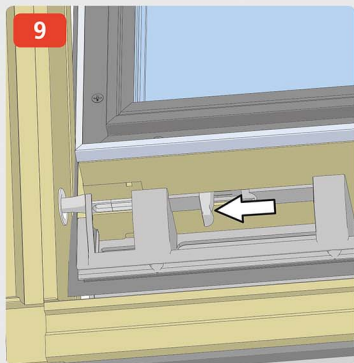

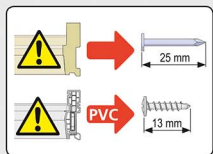

13

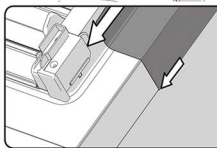
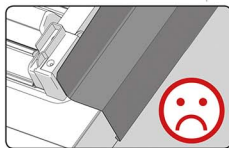
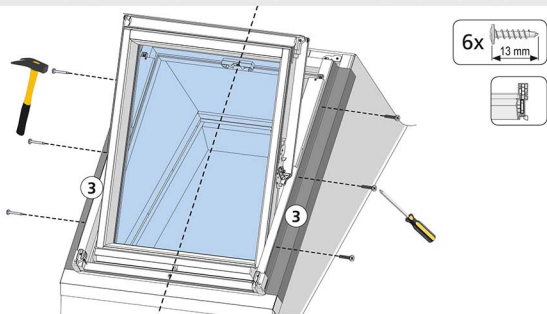

14

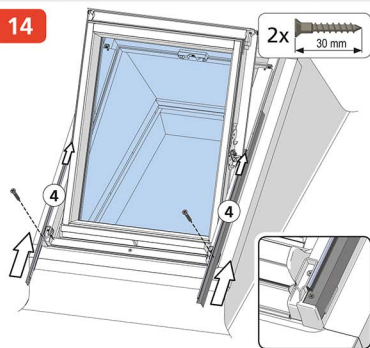

15a

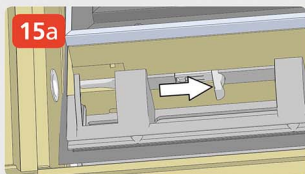

15b

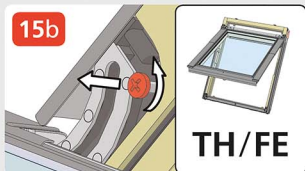

16

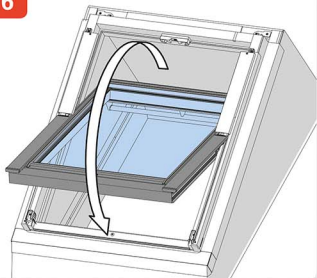

17

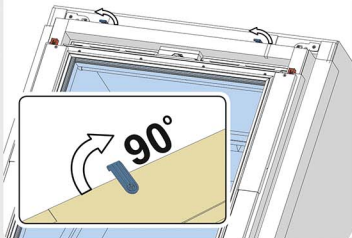

18a

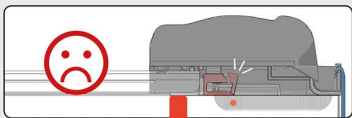
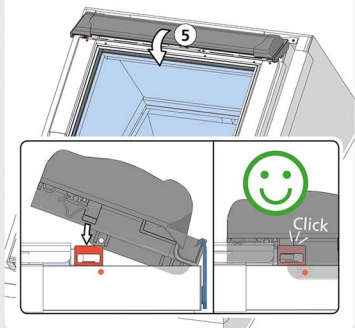

18b

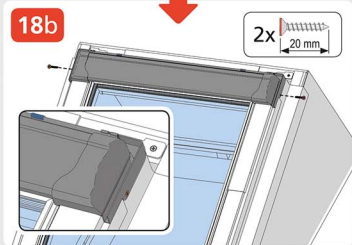

19

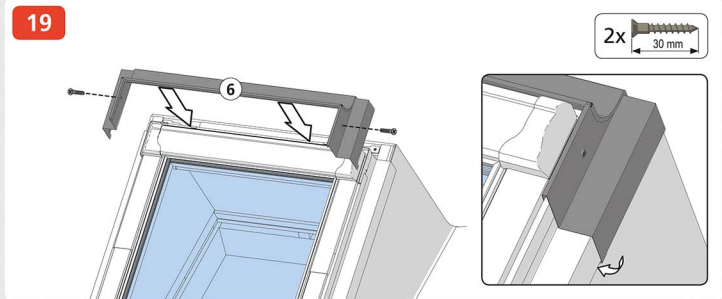

20

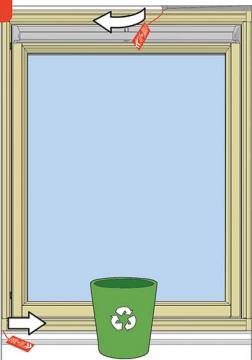

21

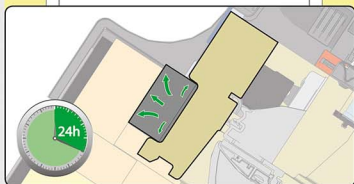
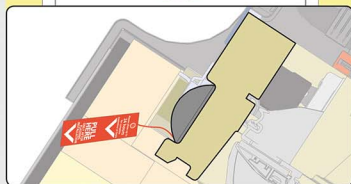
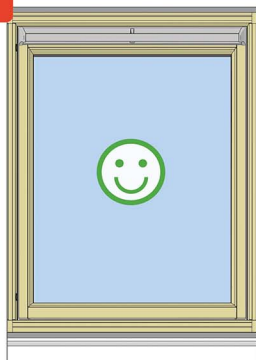

22

