



## FRX



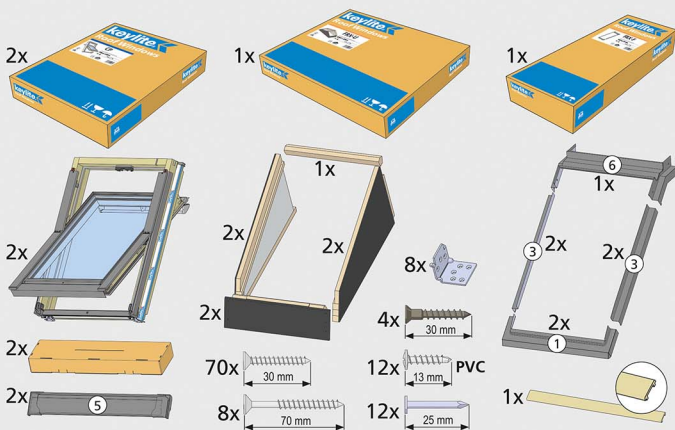

0-5°

Flat Roof System - Apex

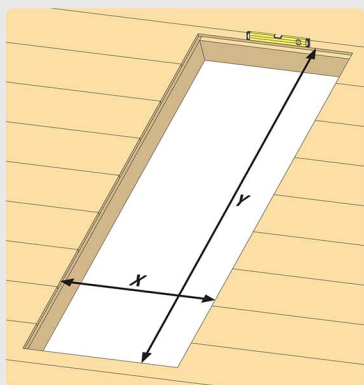
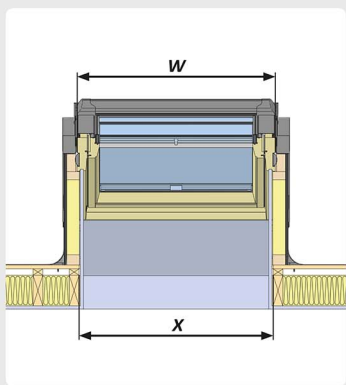
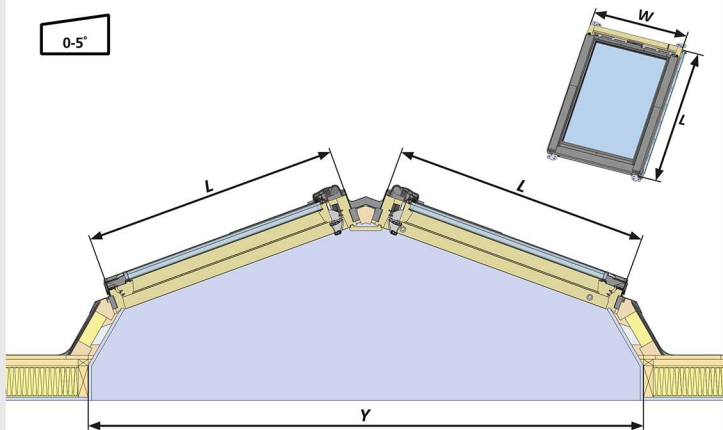

0-5°



$W \times L$	FRX-01	FRX-02	FRX-01C	FRX-03	FRX-04	FRX-05	FRX-06	FRX-07F	FRX-07	FRX-08	FRX-09	FRX-10
 $X \times Y$	550x780	550x980	550x1180	660x1180	780x980	780x1180	780x1400	940x1400	940x1600	1140x1180	1340x980	1340x1400
	530x1740	530x2115	530x2490	640x2490	760x2115	760x2490	760x2900	920x2900	920x3280	1120x2490	1320x2115	1320x2900

1

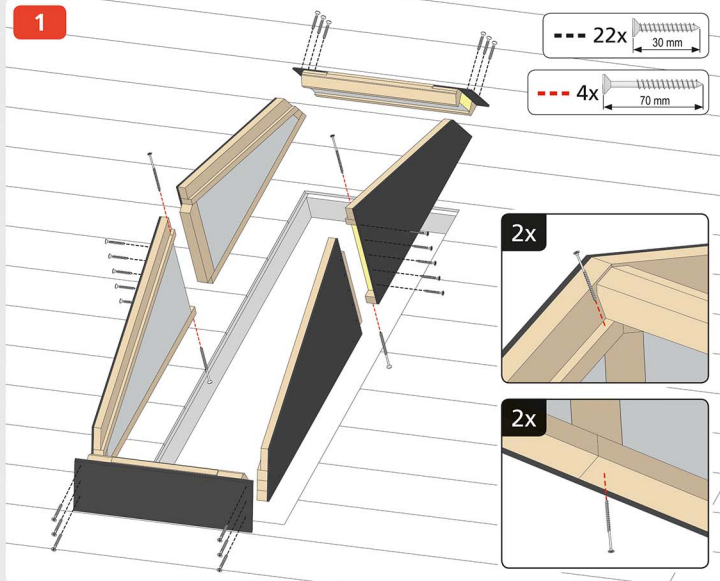

2

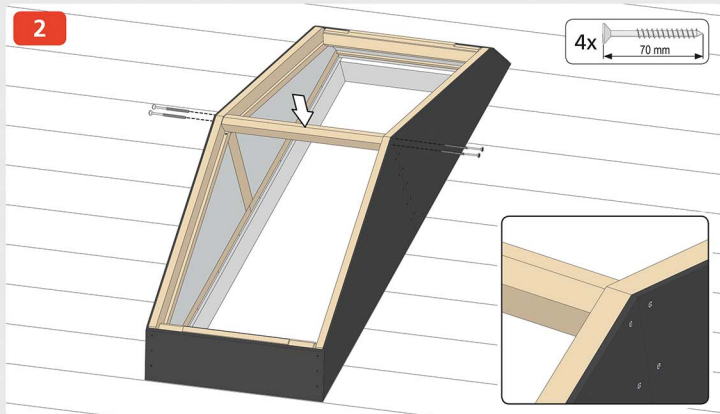

3

16x  30 mm

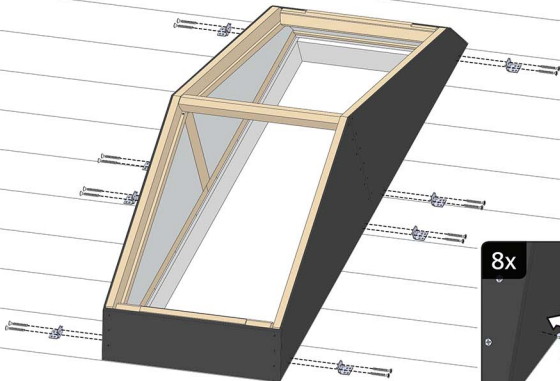

8x

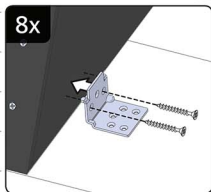

4

16x  30 mm

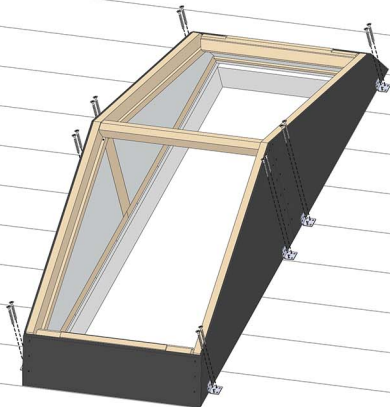

8x

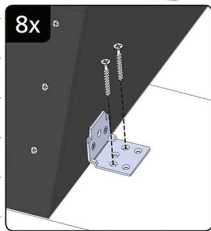

5

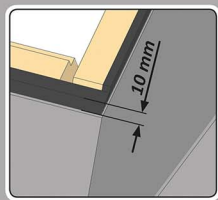

6

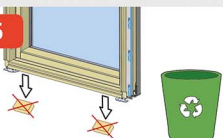

9

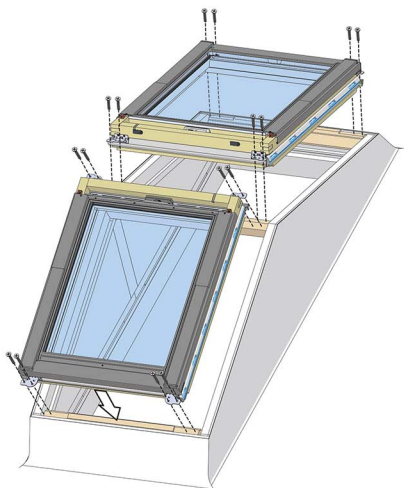
16x  
30 mm

7

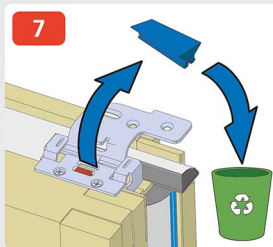

8

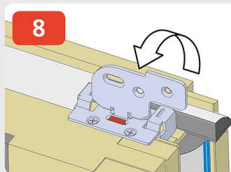

10

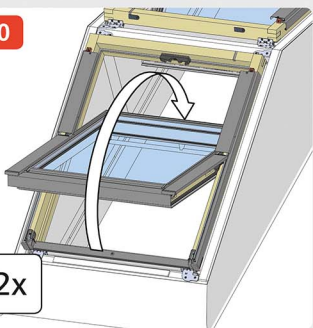

2x

11

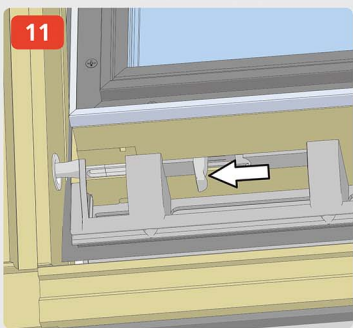

12

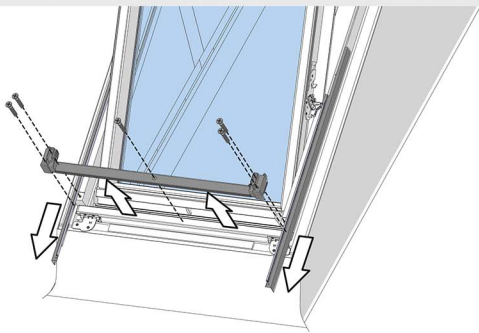

2x

13

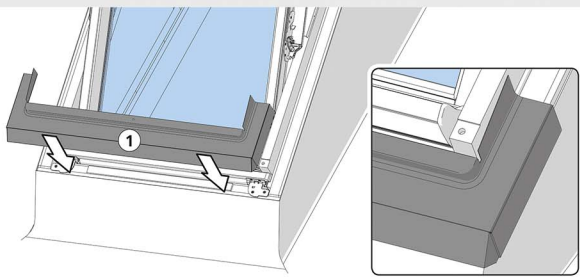

2x

14

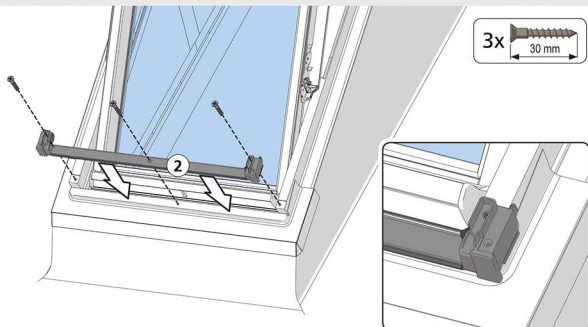
3x  
30 mm

2x

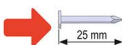

25 mm

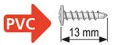

13 mm



TH/FE

max.  
7 mm

15

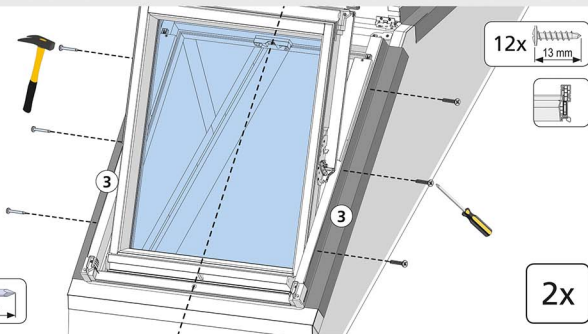
12x  
13 mm12x  
25 mm

2x

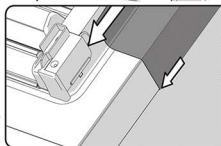
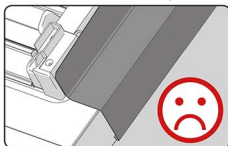

16

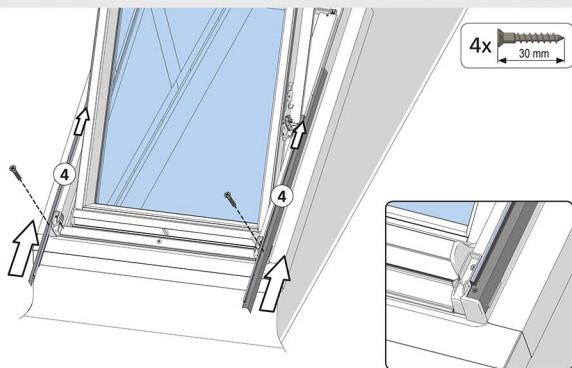

2x

17a

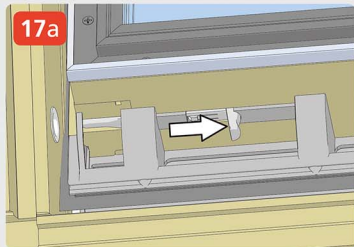

17b

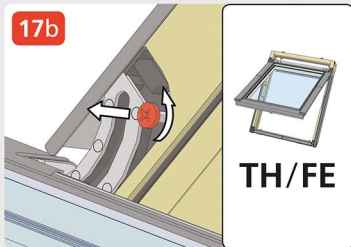

18

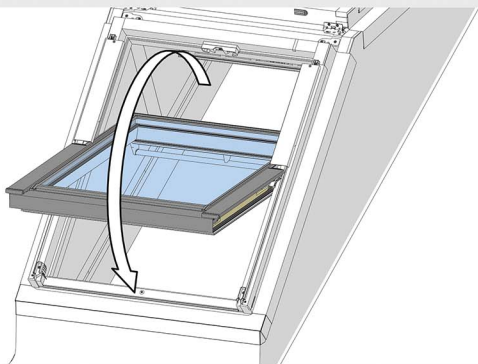

2x



19

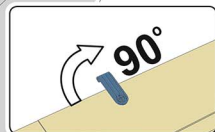
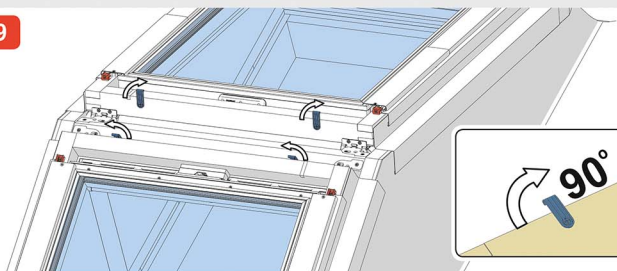

20a

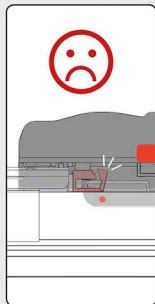
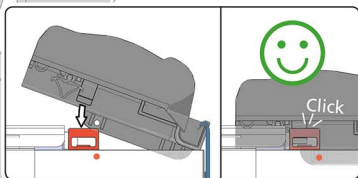
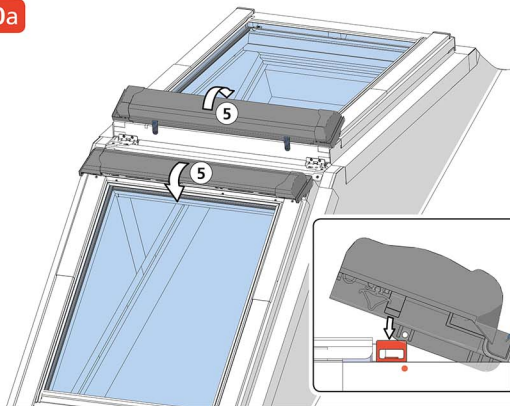

20b

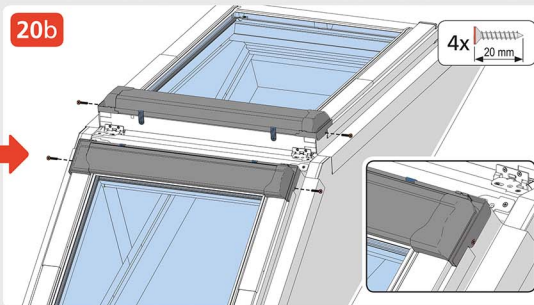

21

4x 30 mm

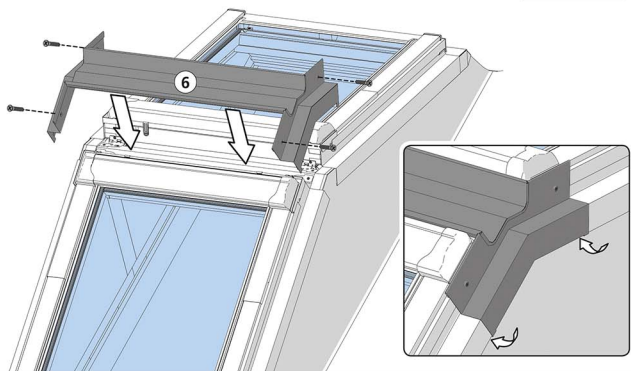

22

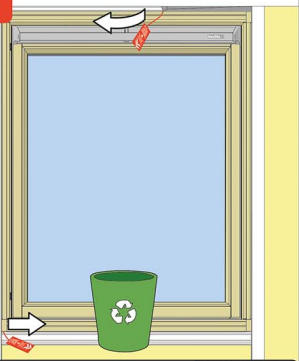

23

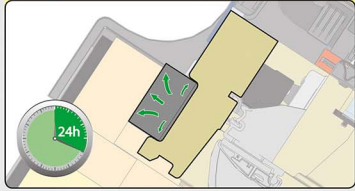
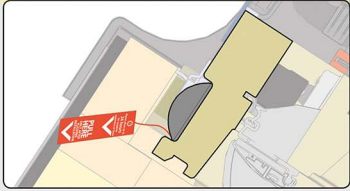
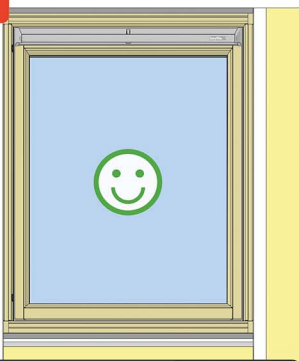

24

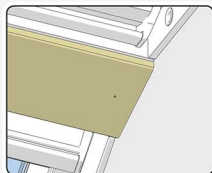
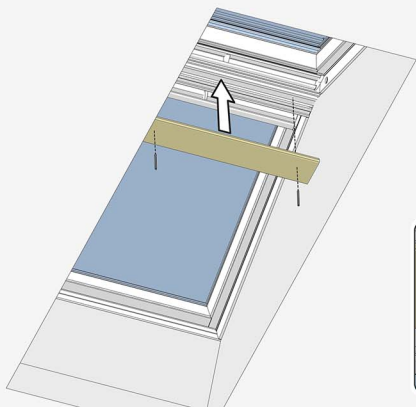

25

