

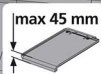

FTRF

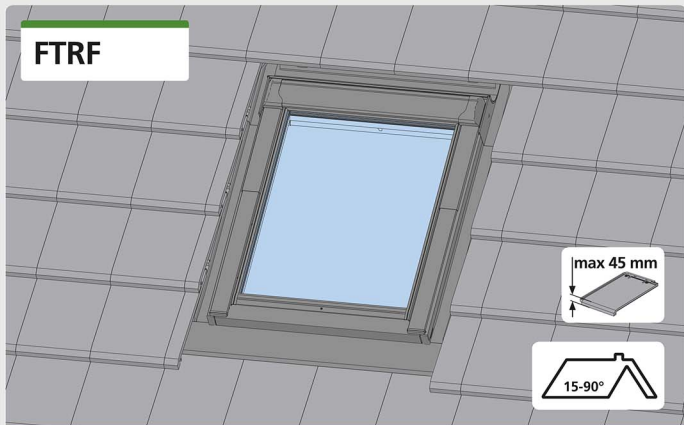

Futuretherm Technology™

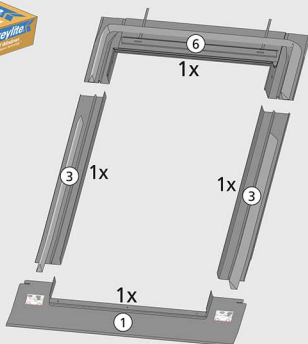
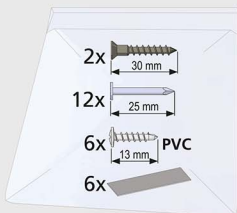

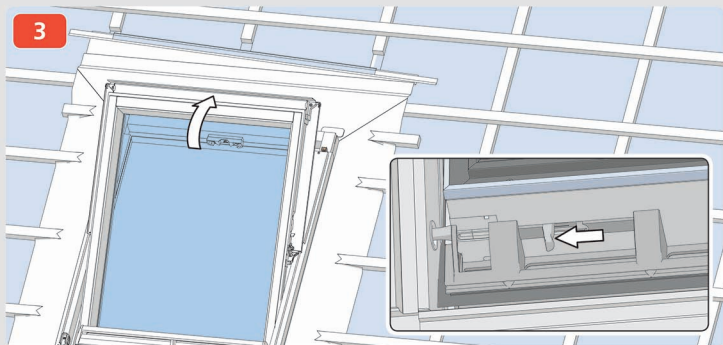
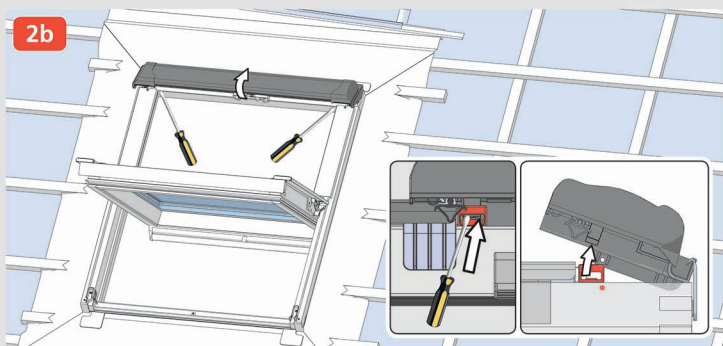
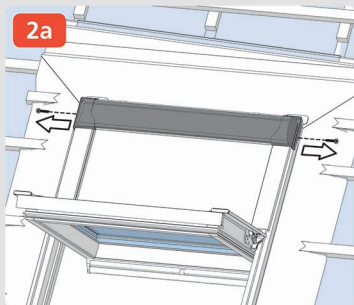
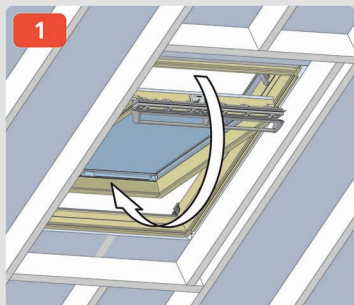

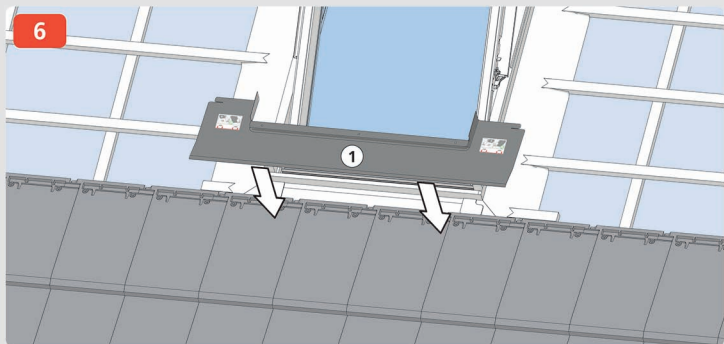
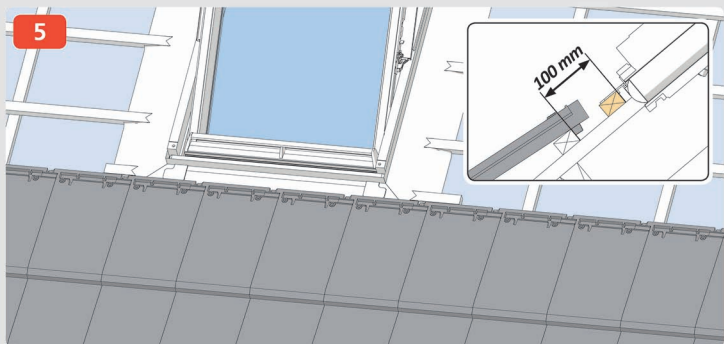
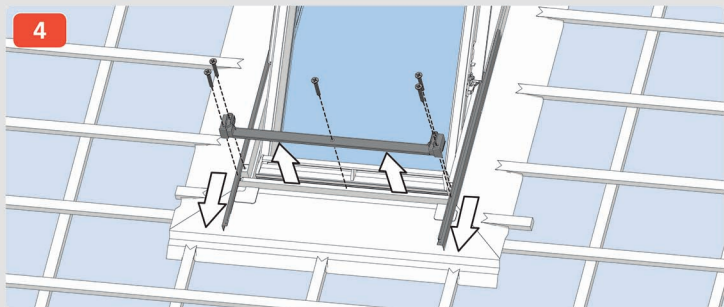

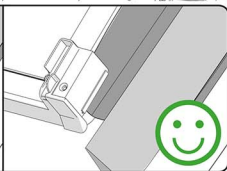
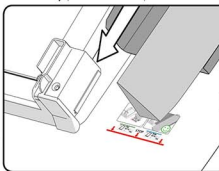
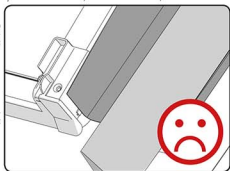
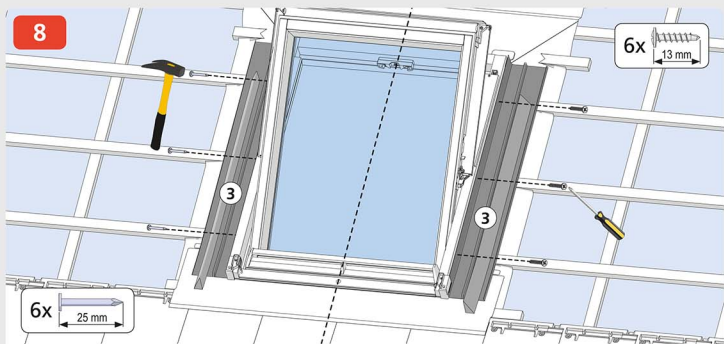
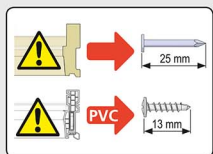
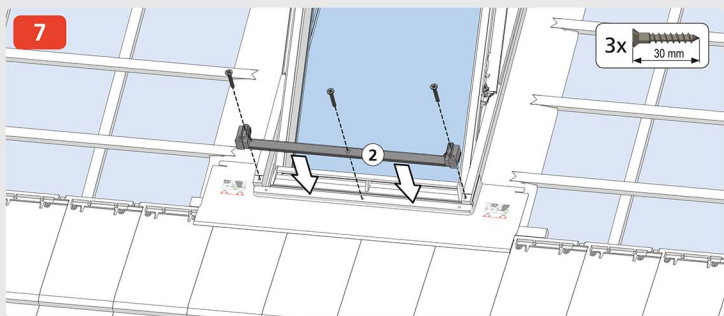

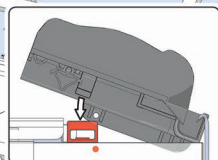
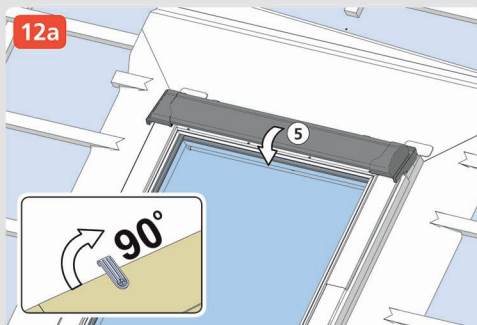
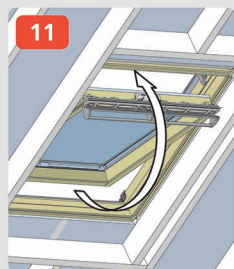
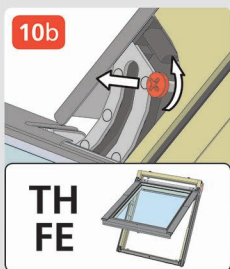
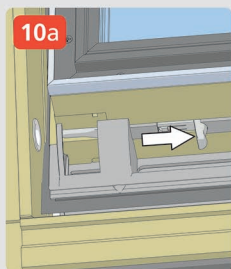
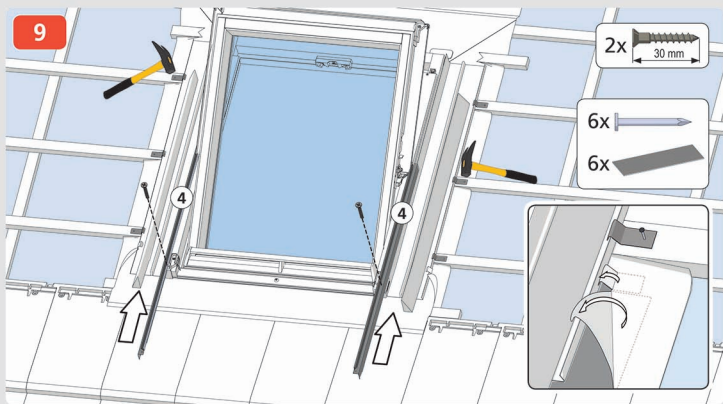

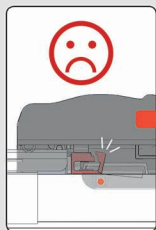

12b

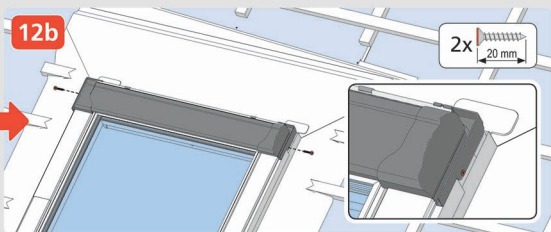

13

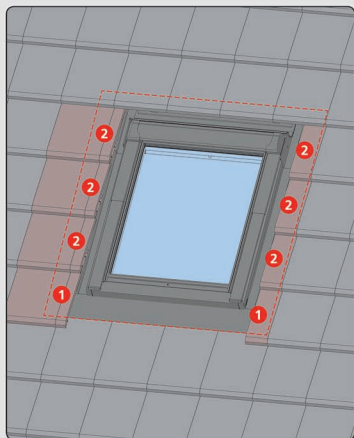
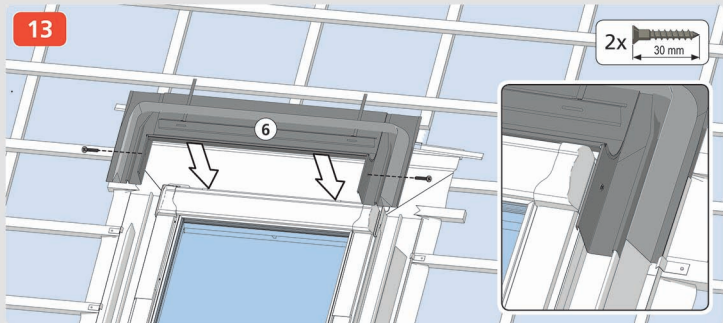

14a

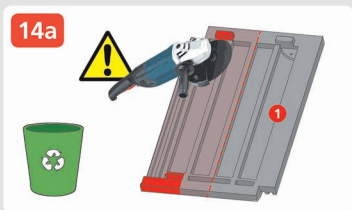

14b

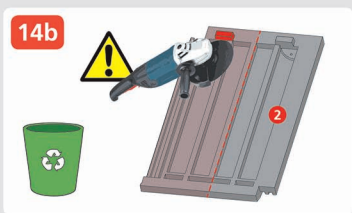

15

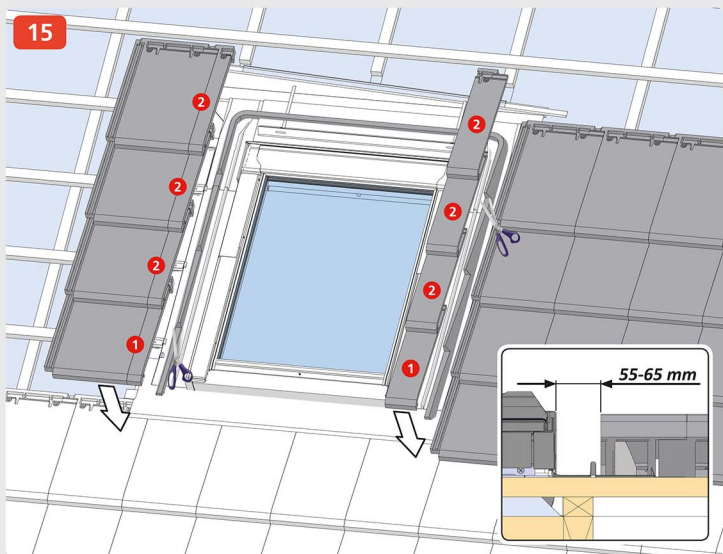

16

