

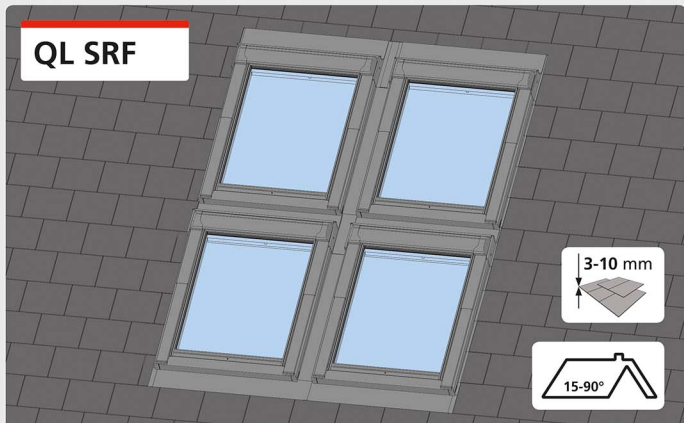

QL SRF

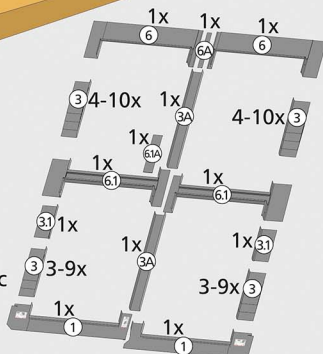

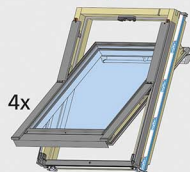
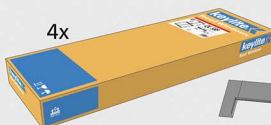

Grid System - Slate Roof Flashing

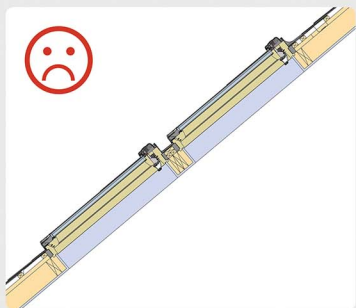
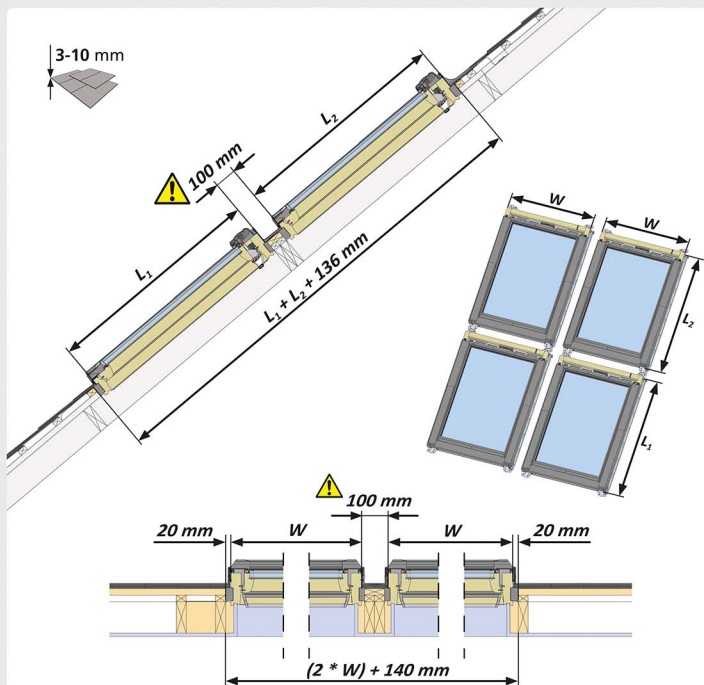

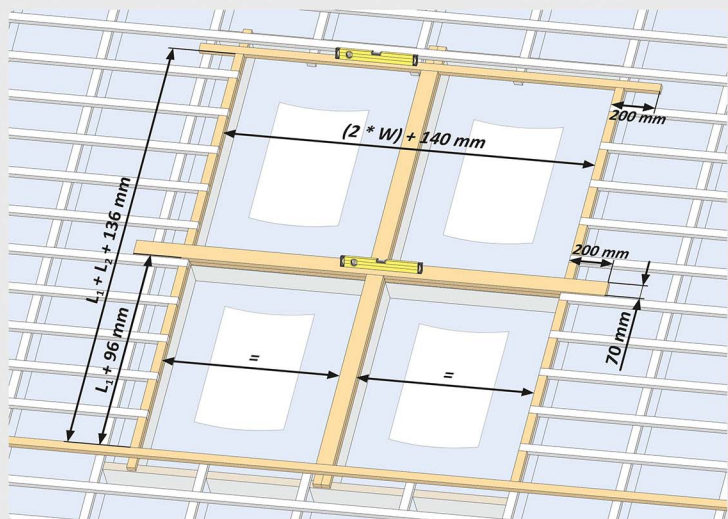





i

Q_{ty}	L_A
 2	$L_1 + L_2 + 136 \text{ mm}$
 3	$L_1 + L_2 + L_3 + 232 \text{ mm}$
X	$L_1 + \dots + L_x + (96 * X - 56) \text{ mm}$

Q_{ty}	W_A
 2	$(2 * W) + 140 \text{ mm}$
 3	$(3 * W) + 240 \text{ mm}$
X	$(X * W) + (X * 100) - 60 \text{ mm}$

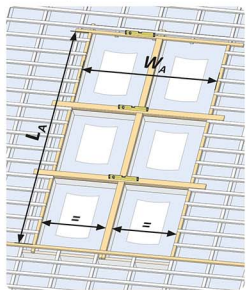

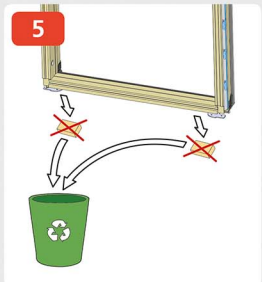
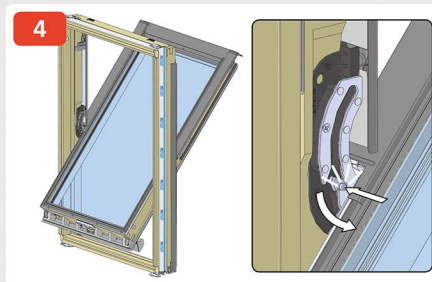
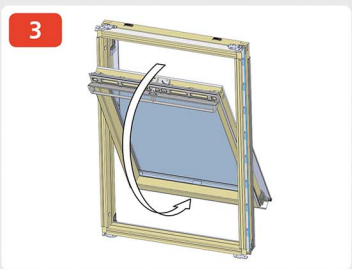
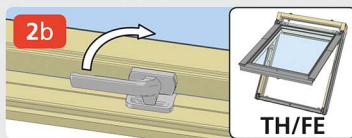
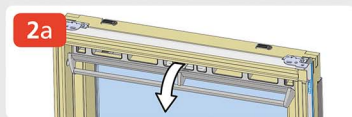
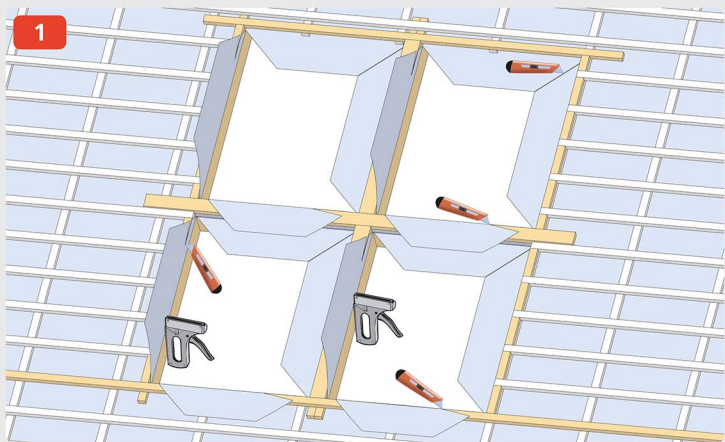

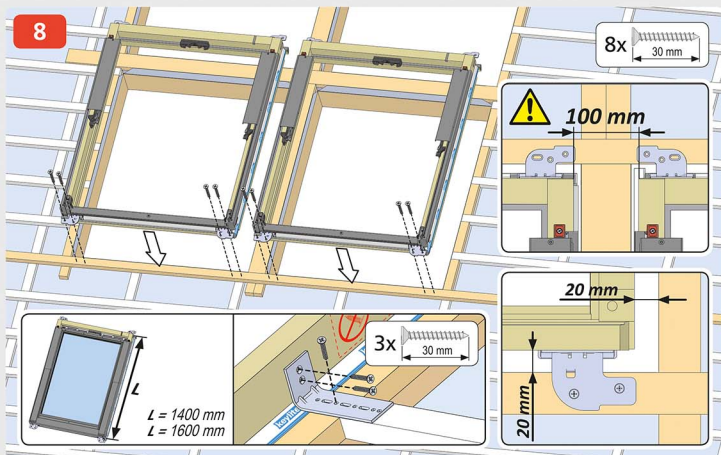
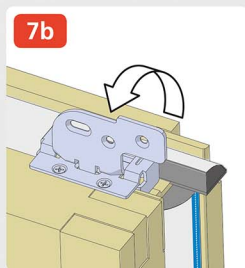
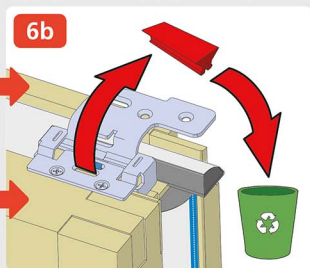
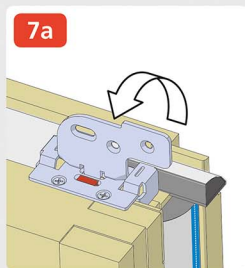
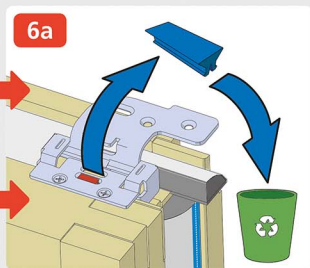

9

8x

30 mm

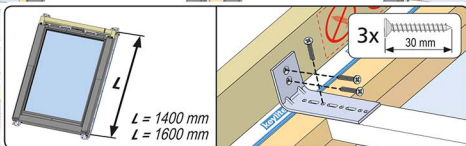
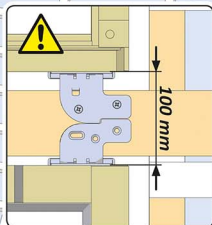
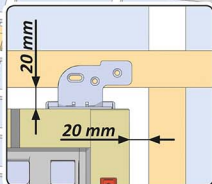

10

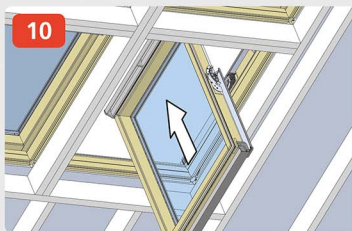

11

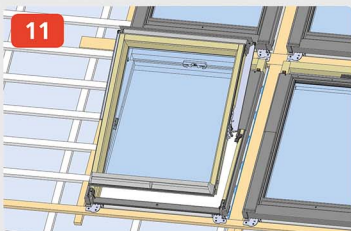

12

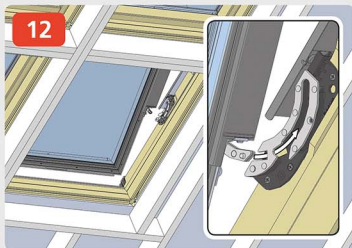

13

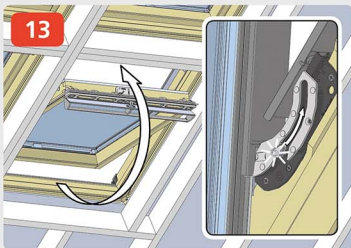

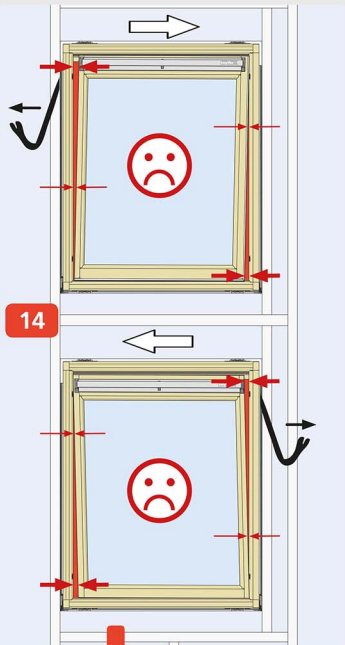

14

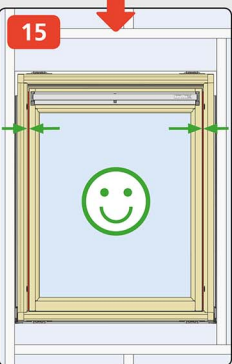

15

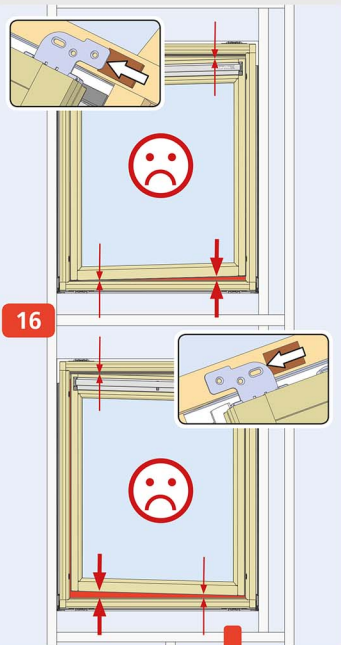

16

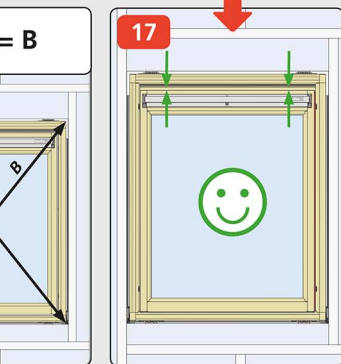

17

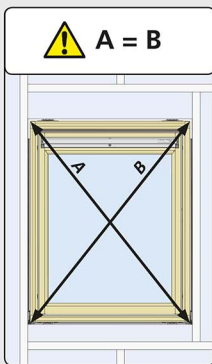

! A = B

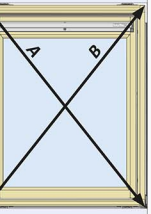

18

16x

30 mm

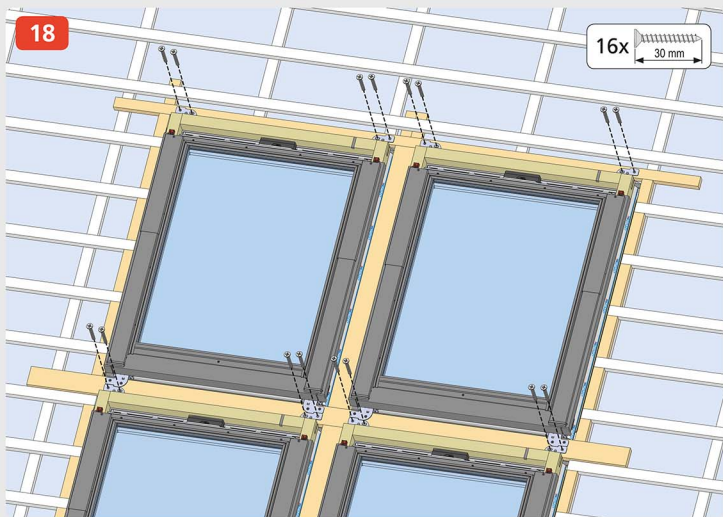

4x



19

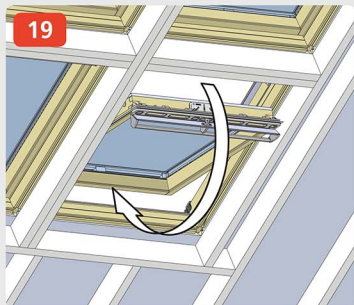

20

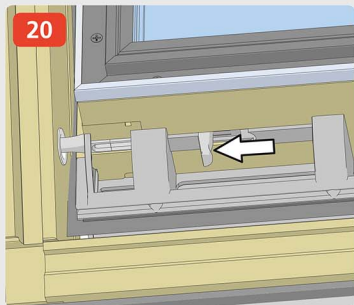

21

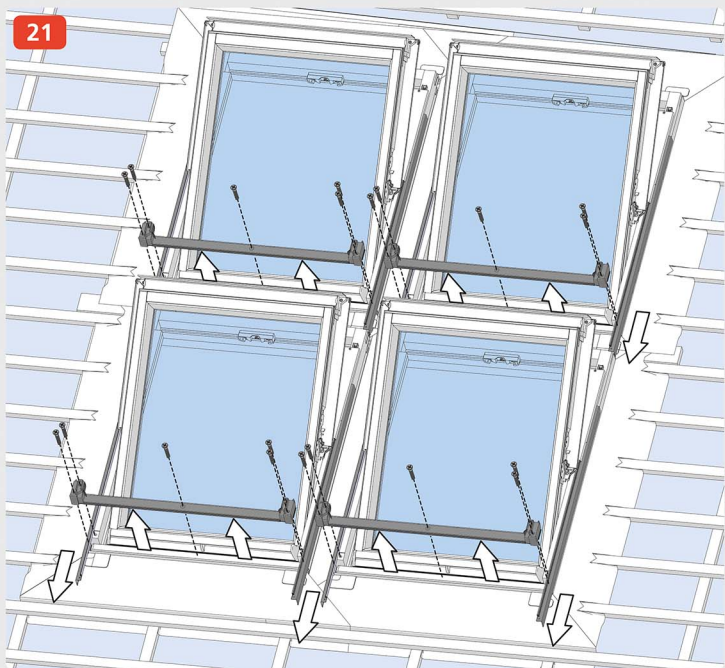

22

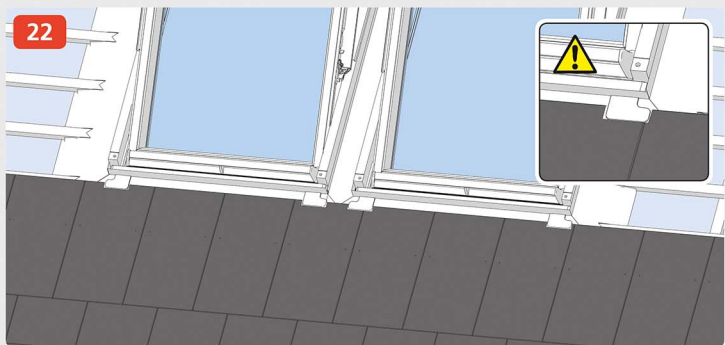

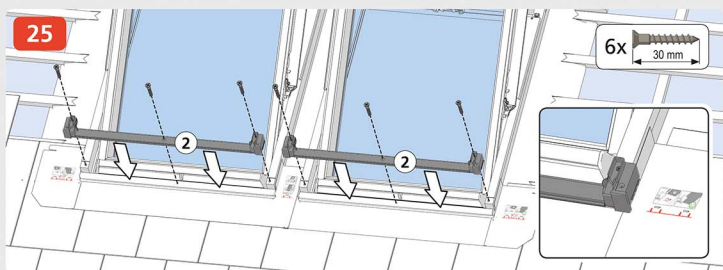
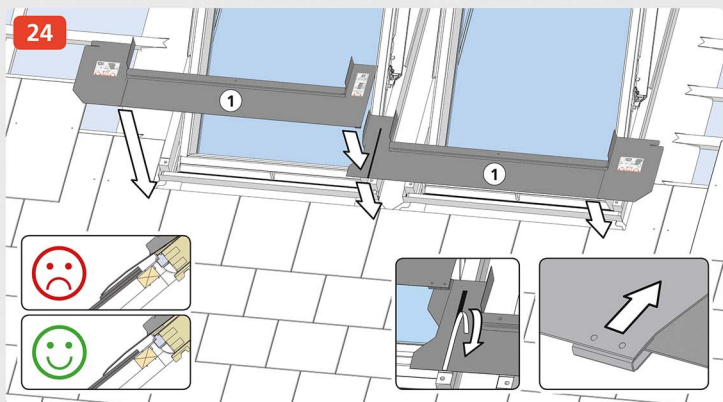

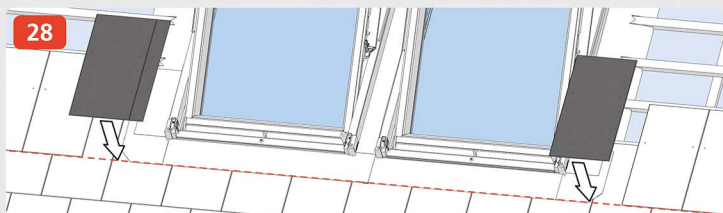
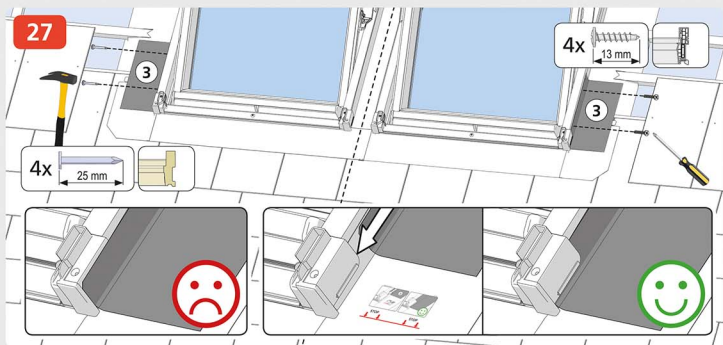
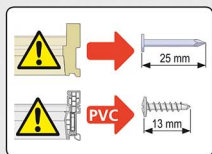
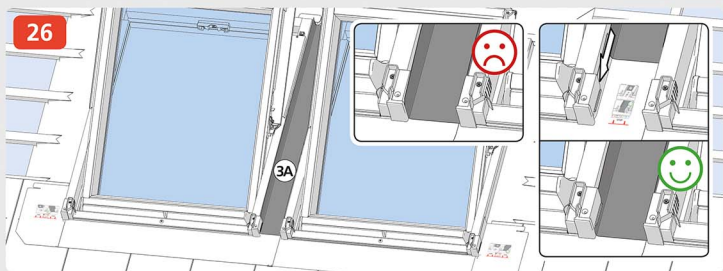

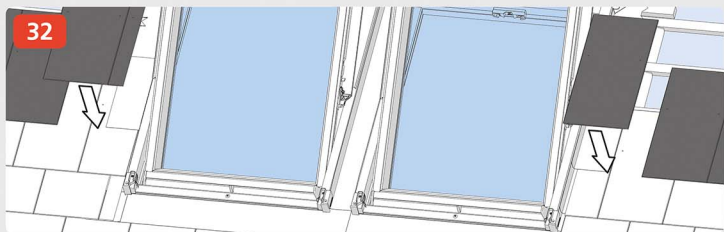
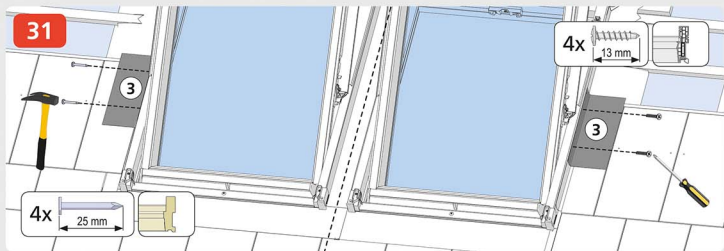
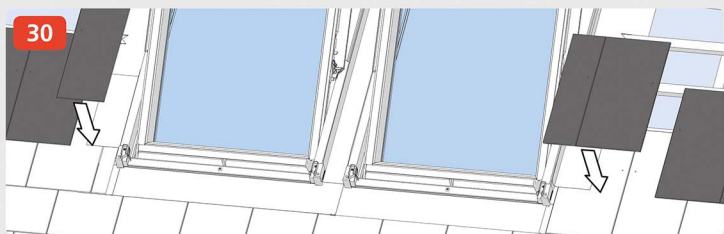
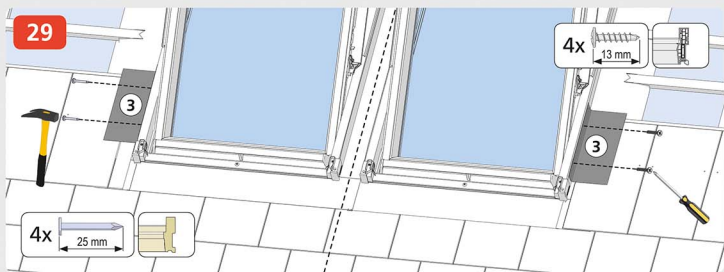

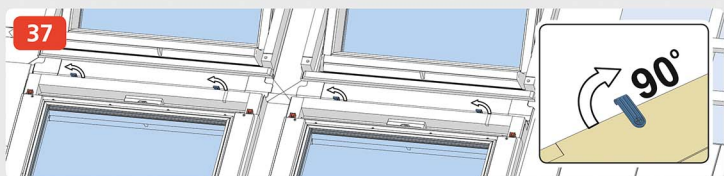
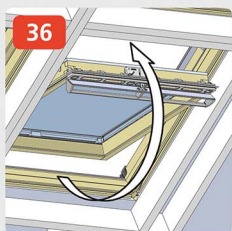
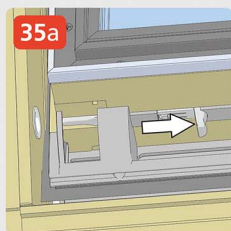
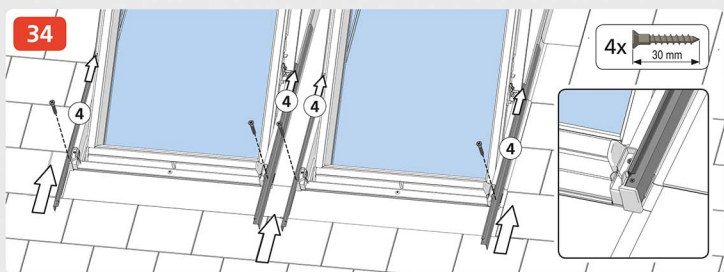
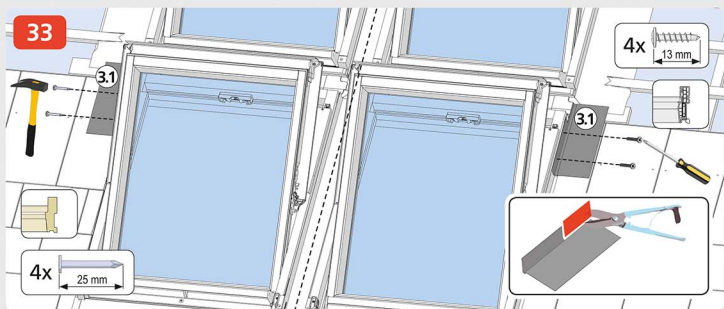

38a

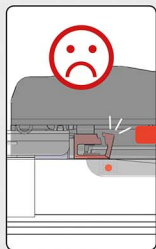
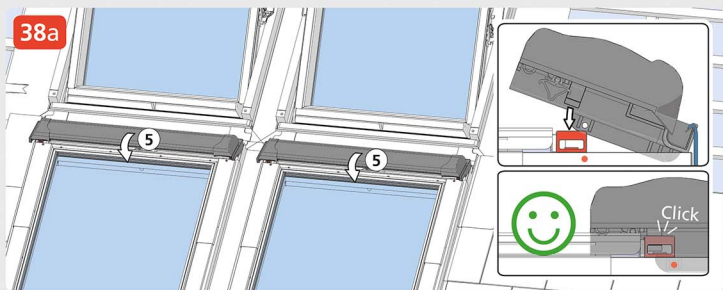

38b

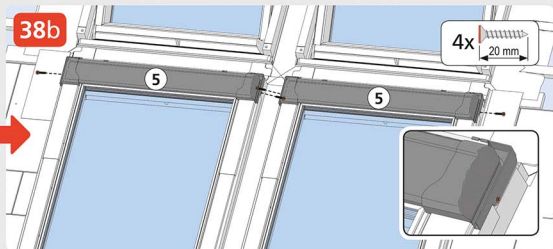

39

