

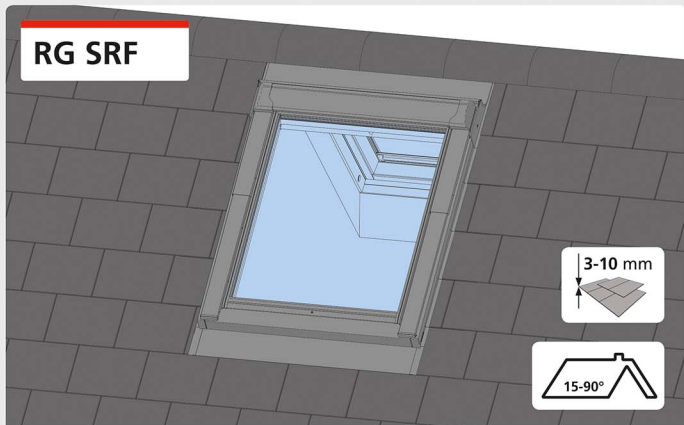

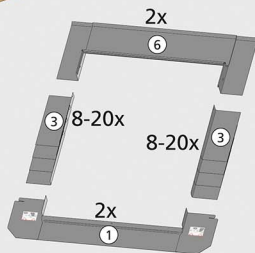

RG SRF

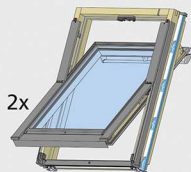
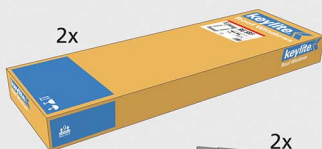

Ridge System - Slate Roof Flashing





 **max R = 280 mm**

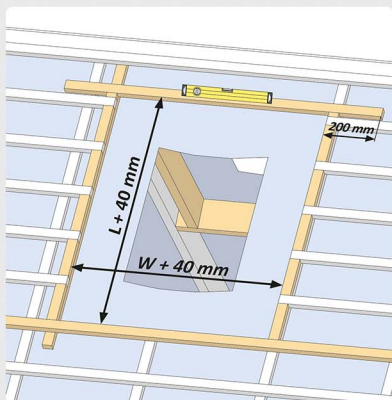
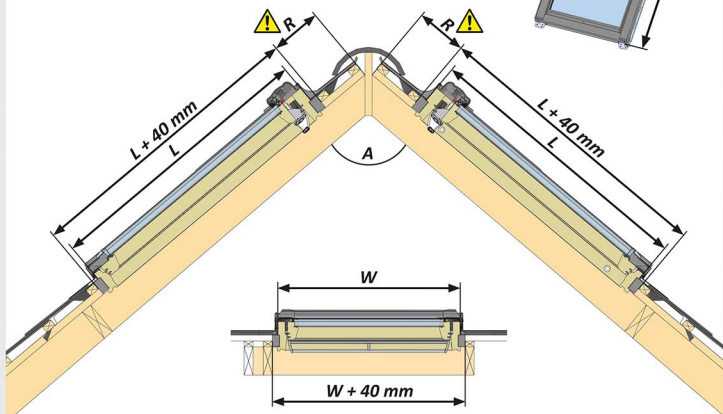
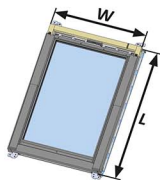

minimum R (mm)

A	L	minimum R (mm)				
		780	980	1180	1400	1600
140°	80	80	80	80	80	80
130°	80	80	80	80	80	80
120°	80	80	80	80	80	80
110°	80	80	80	80	80	100
100°	80	80	80	80	120	140
90°	80	80	120	180	200	
80°	80	120	180	260		
70°	100	180	260			
60°	140	260				

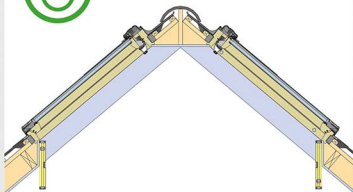
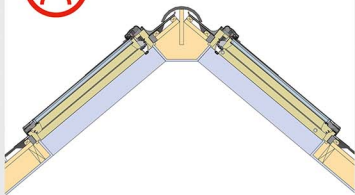

1

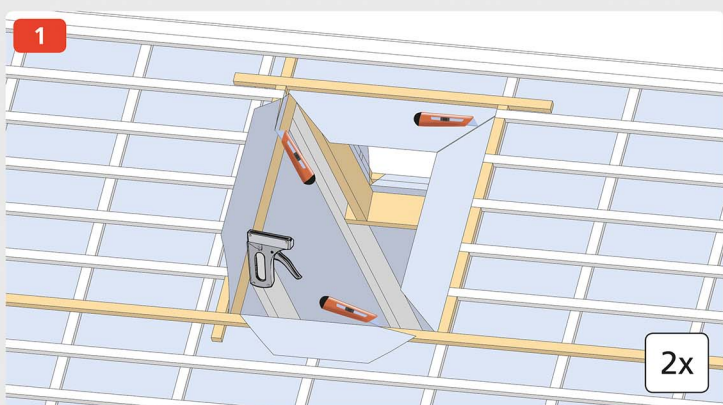

2a

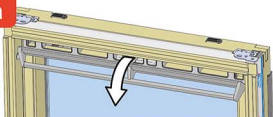

2b

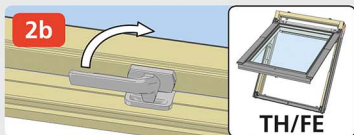

3

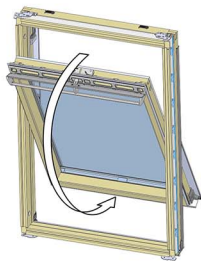

4

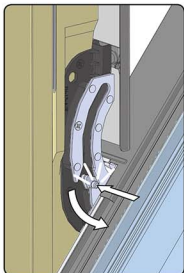

5

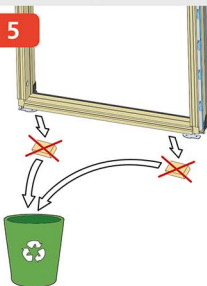

6a

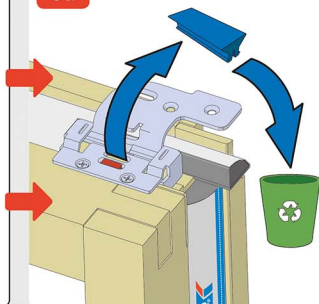

7a

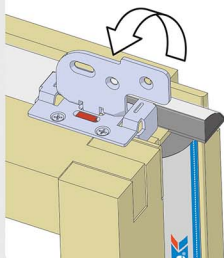

7,8,9,10 mm



6b

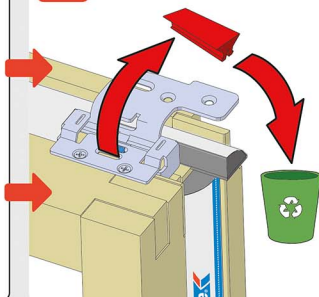

7b

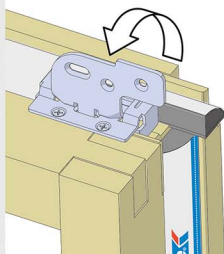

3,4,5,6 mm



8

8x 30 mm

2x

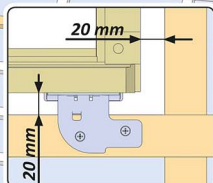
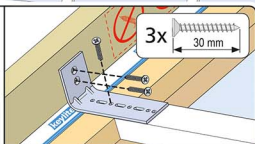
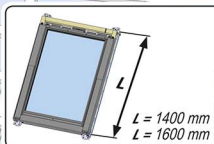

9

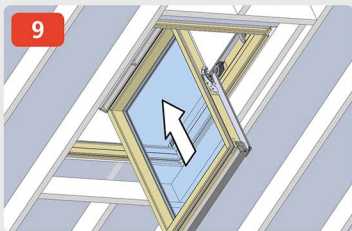

10

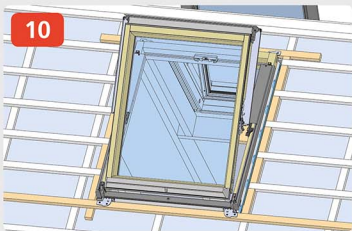

11

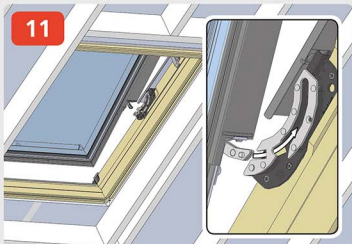

12

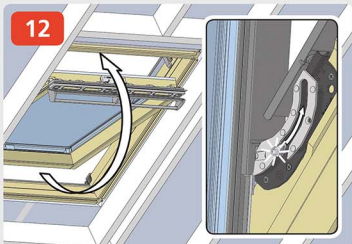

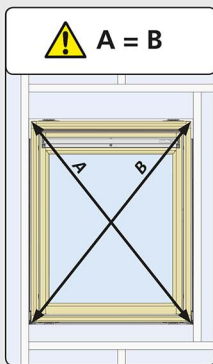
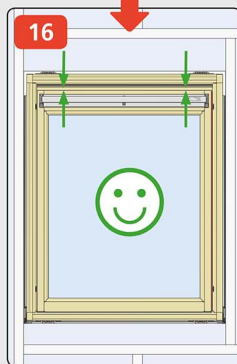
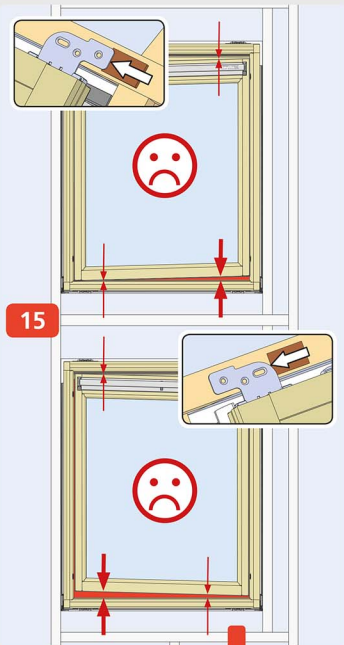
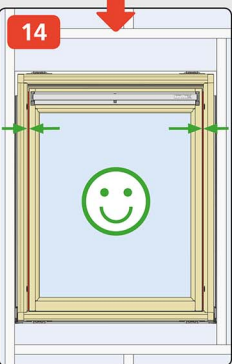
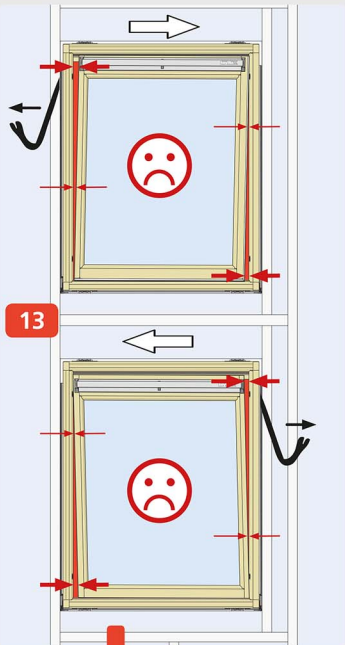

17

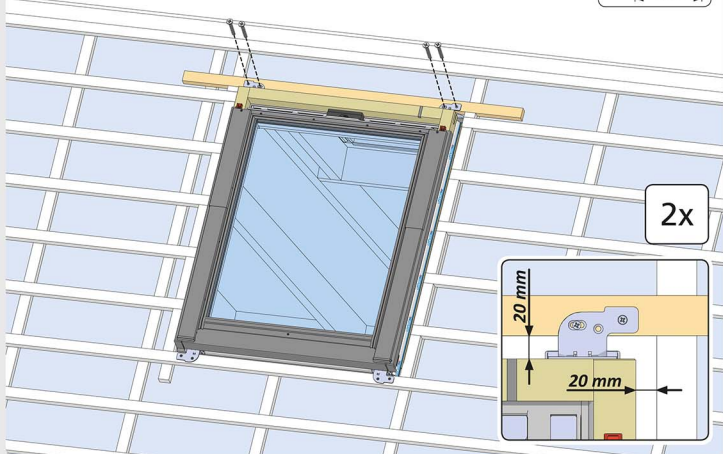
8x  30 mm

2x



18

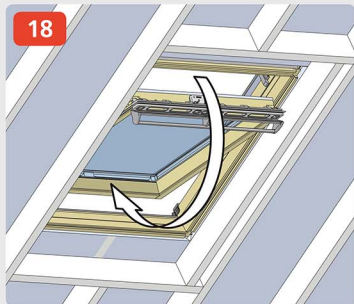

19

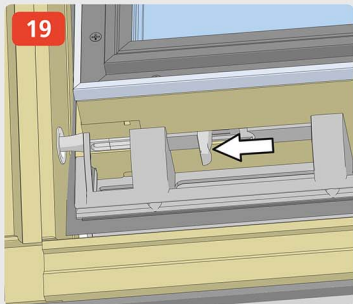

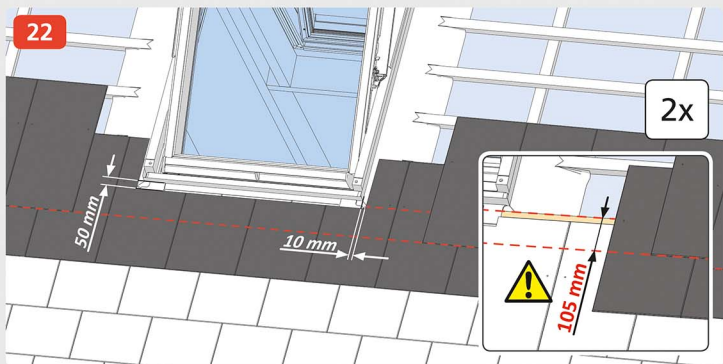
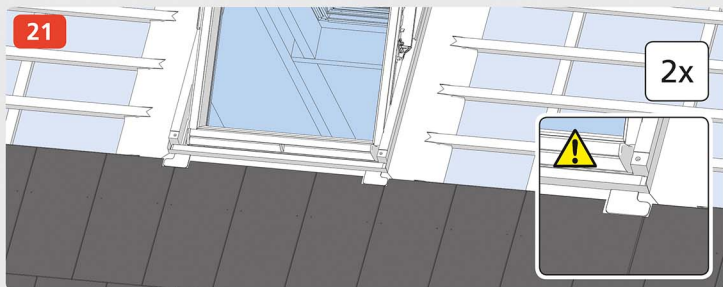
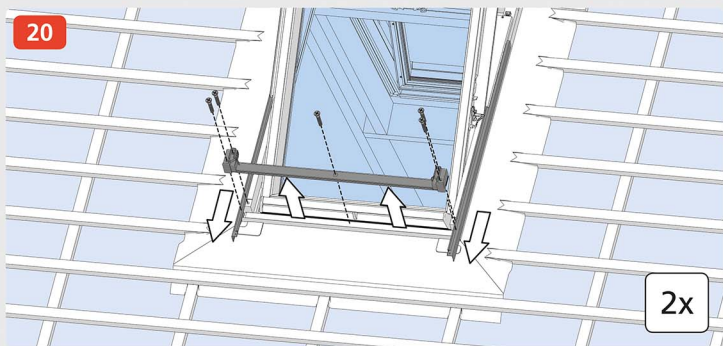

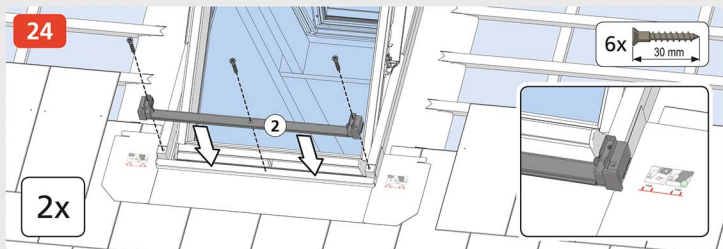
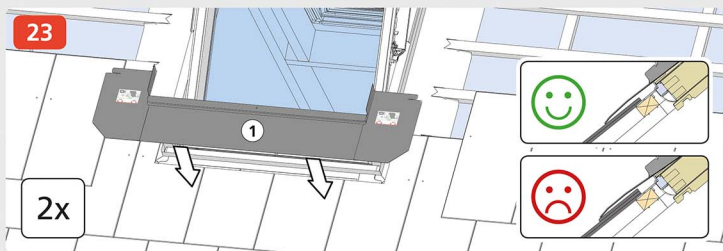

26

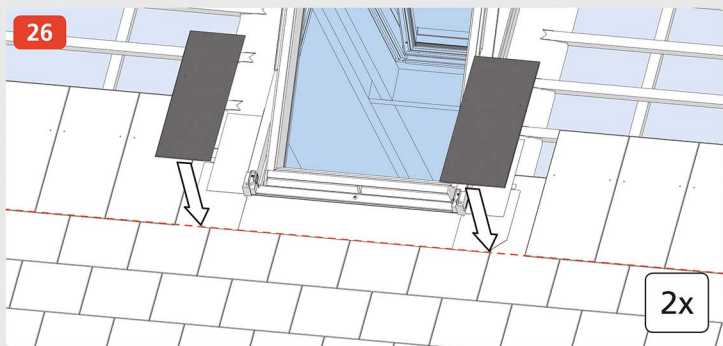

27

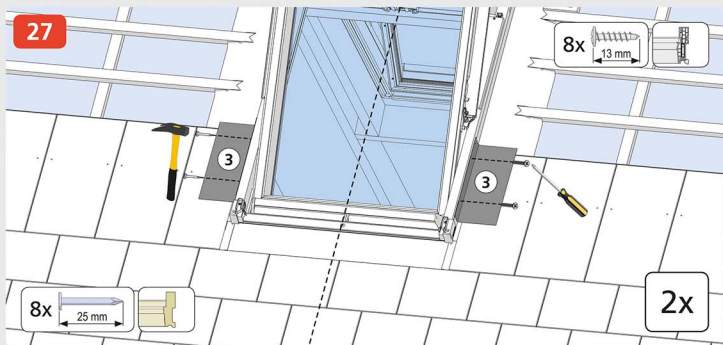

28

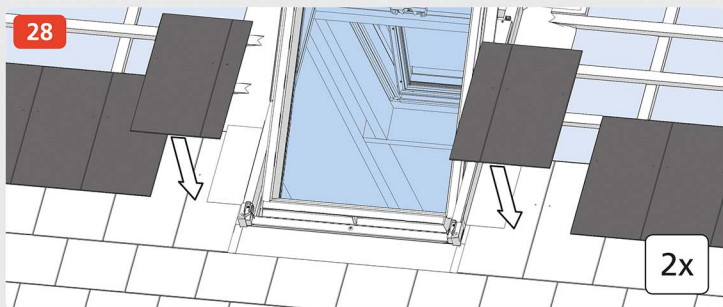

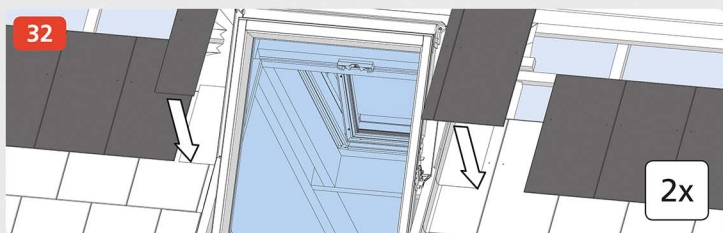
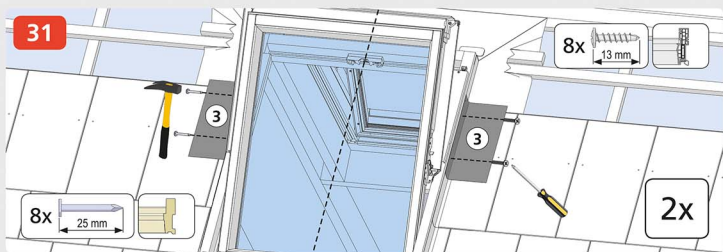
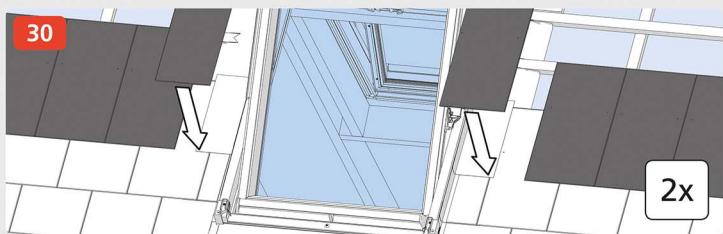
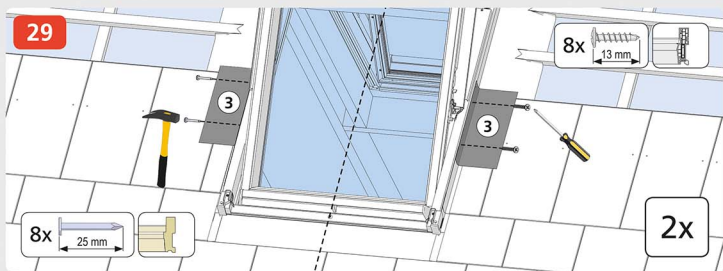

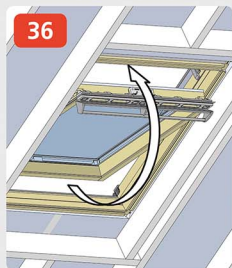
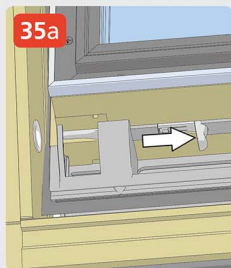
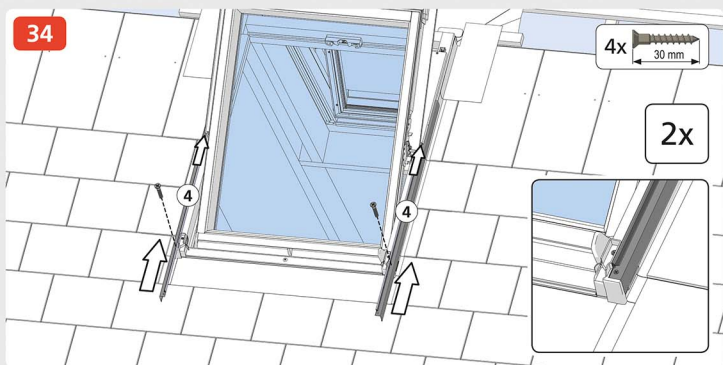
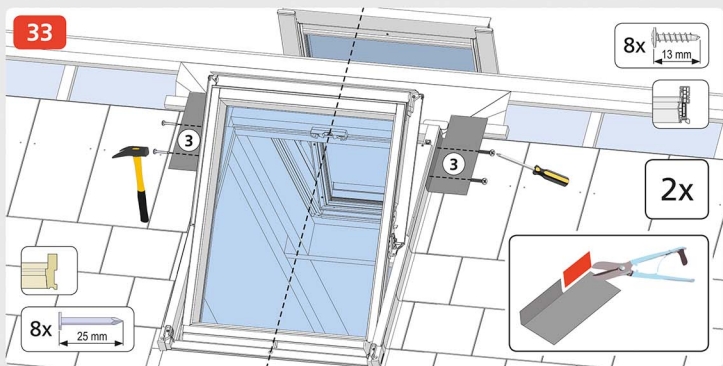

37

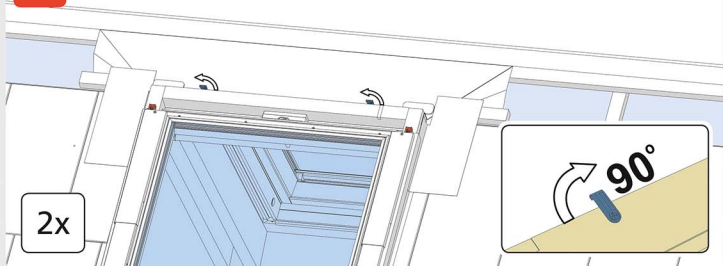

38a

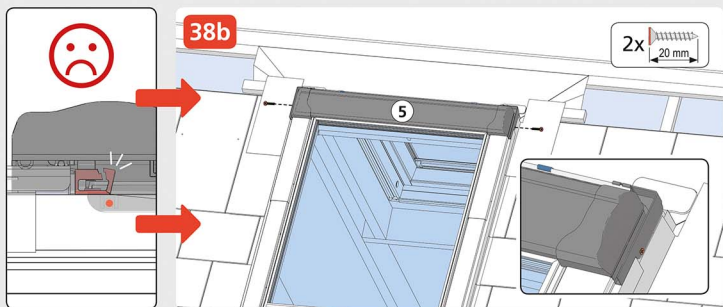
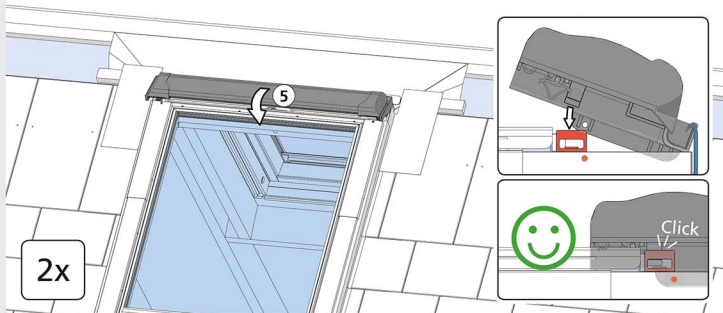

39

4x  30 mm

6

2x

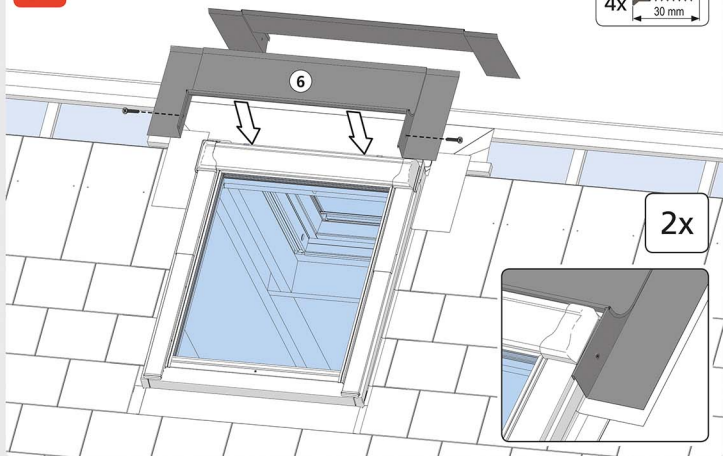

40

60-150 mm

