

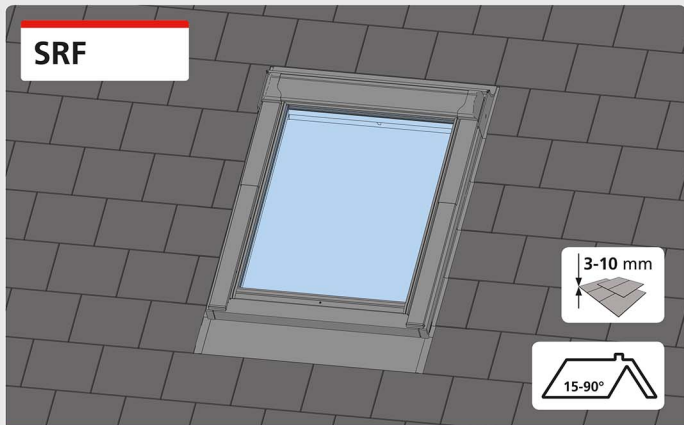

SRF



3-10 mm



15-90°

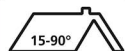

Slate Roof Flashing

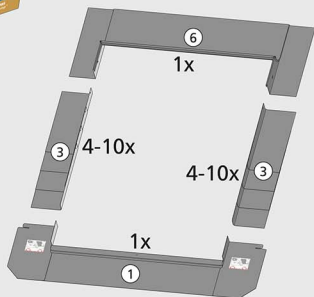
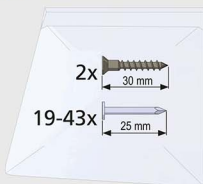

PVC



13 mm

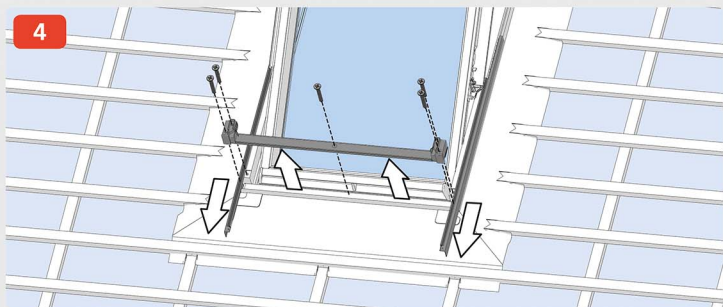
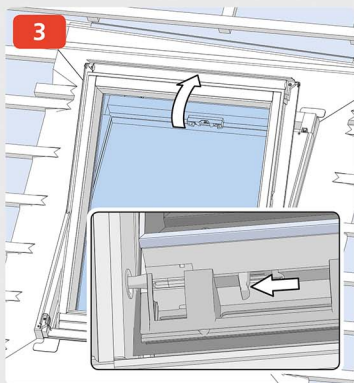
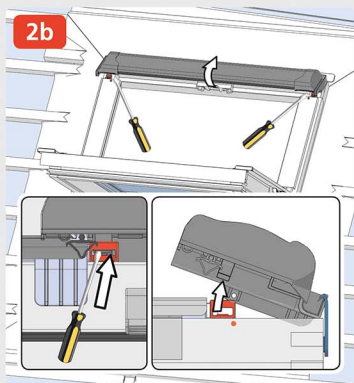
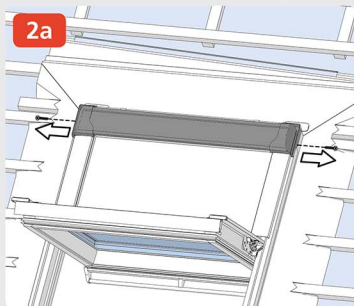
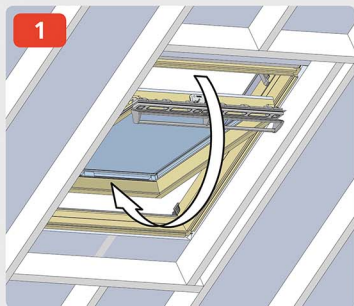

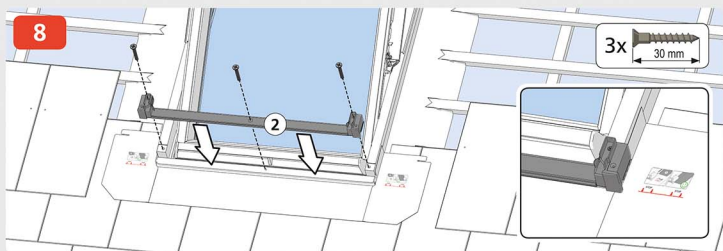
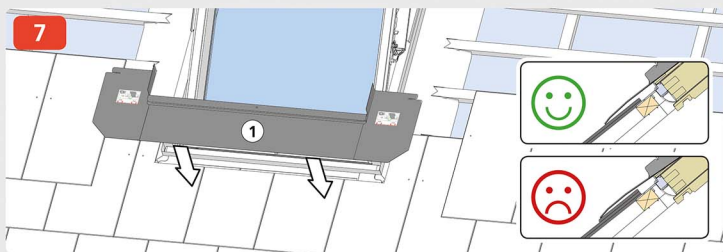
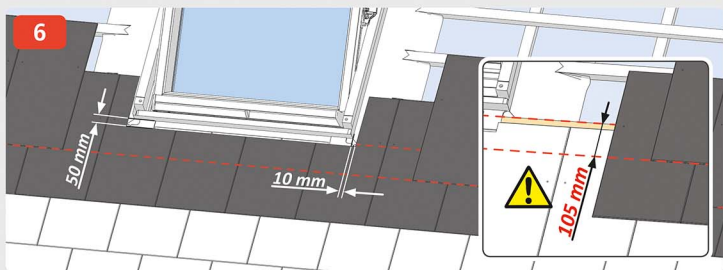
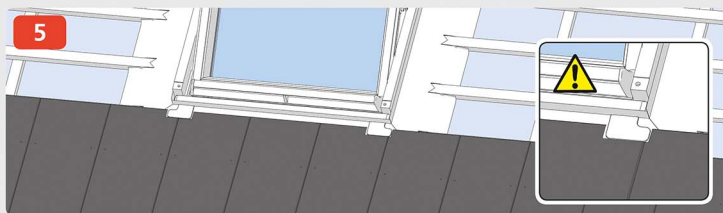

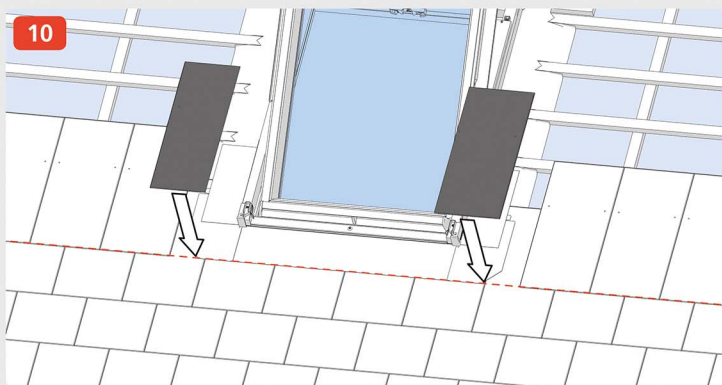
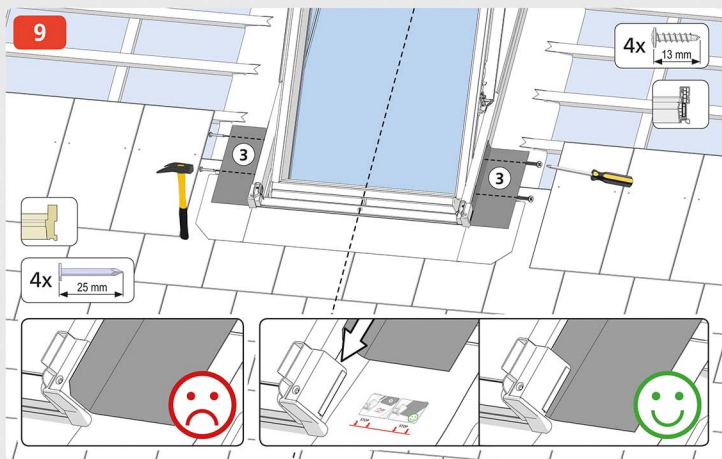
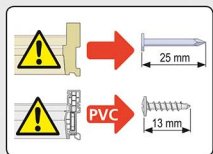

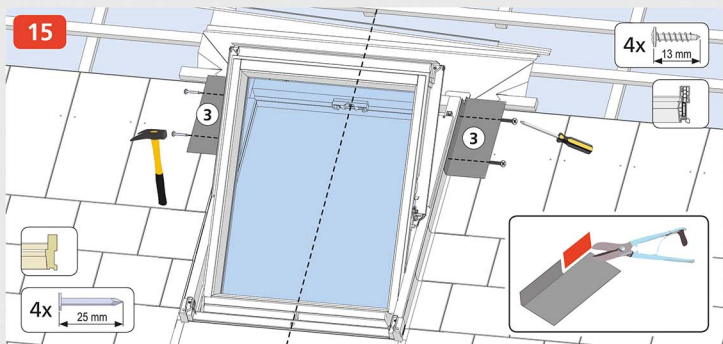
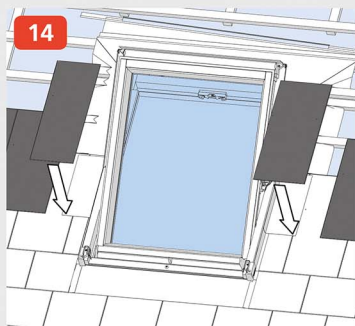
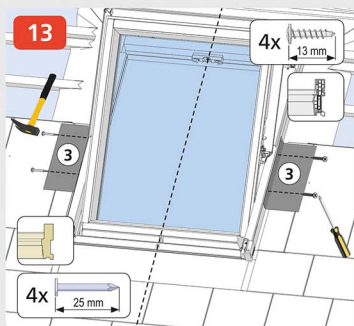
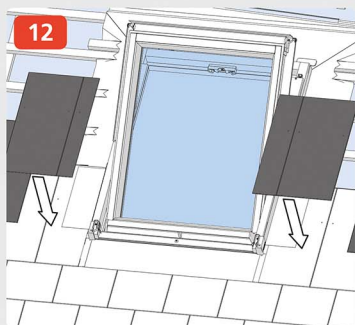
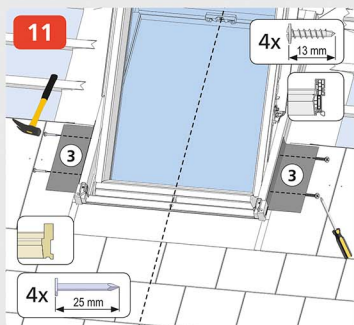

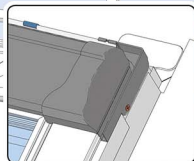
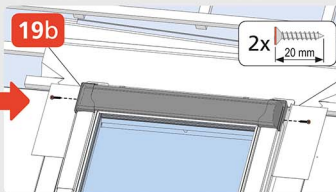
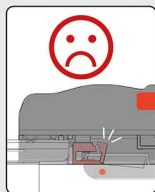
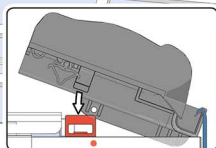
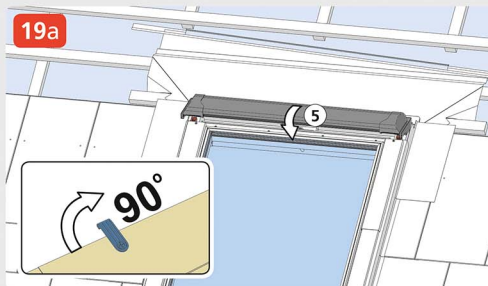
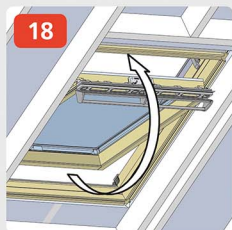
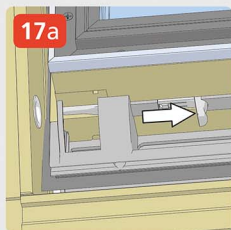
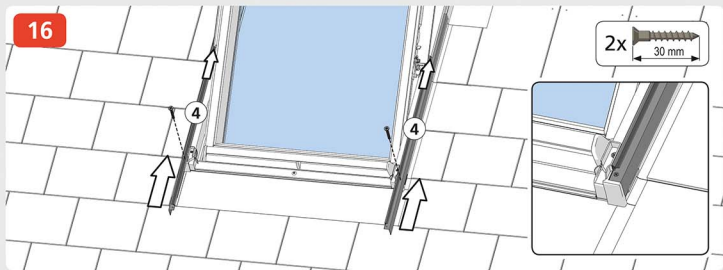

20

2x 30 mm

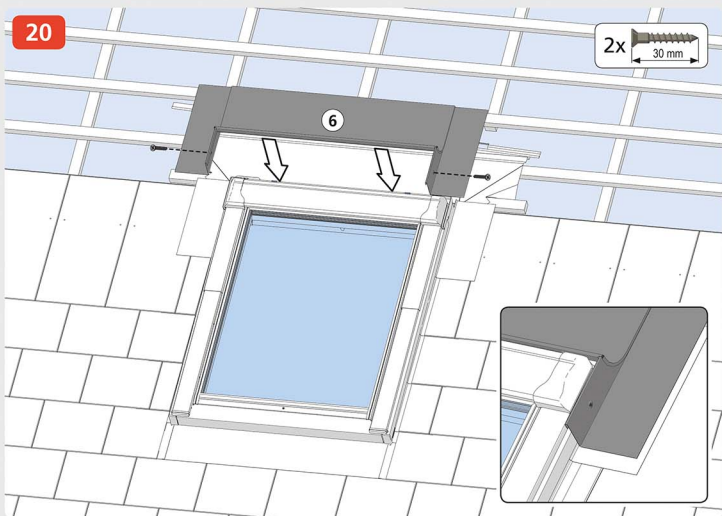

21

