

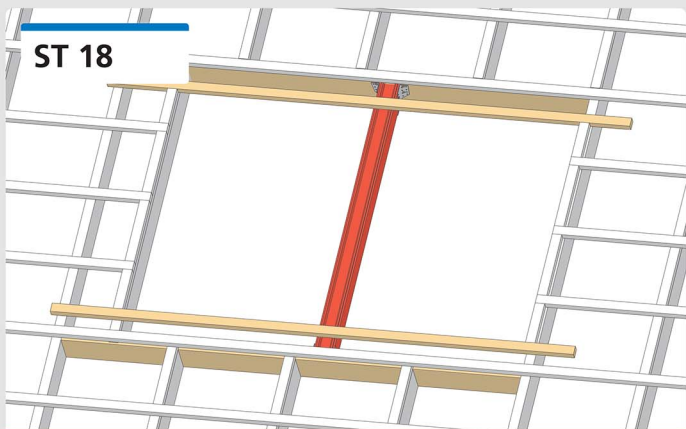

ST 18

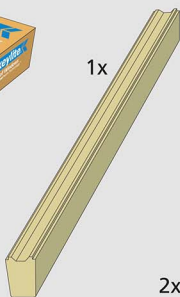

Futuretherm Technology™



18



2x

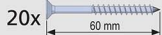
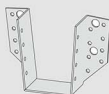

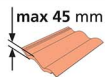

max 45 mm

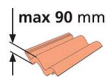

max 90 mm



3-10 mm



10 - 15 mm



TRF

Widura + Widura

CE



DTRF

Widura + Widura

CE



SRF

Widura + Widura

CE



PTRF

Widura + Widura

CE

Z = 100 mm

Z = 120 - 140 mm

Z = 100 mm

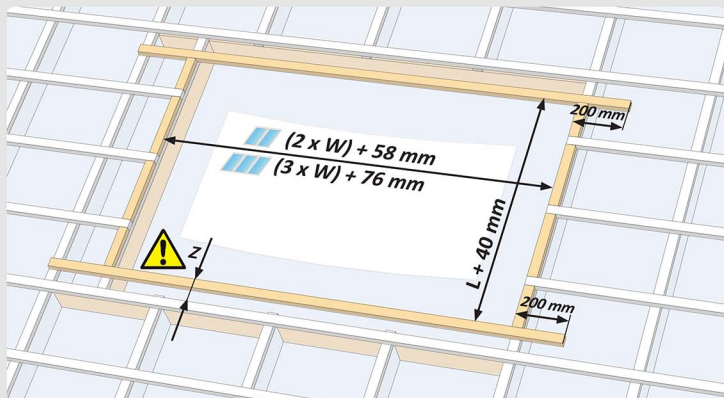
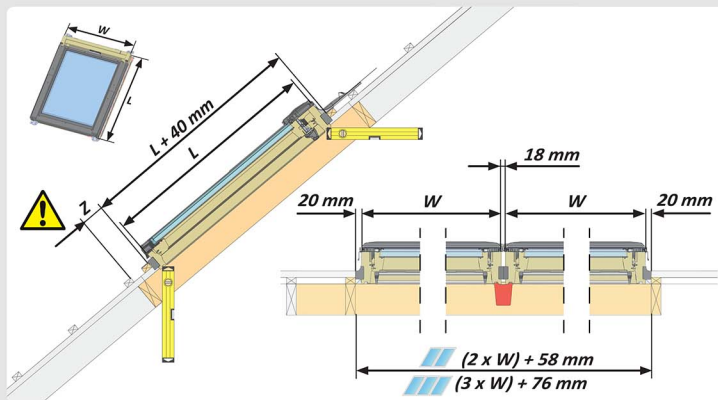

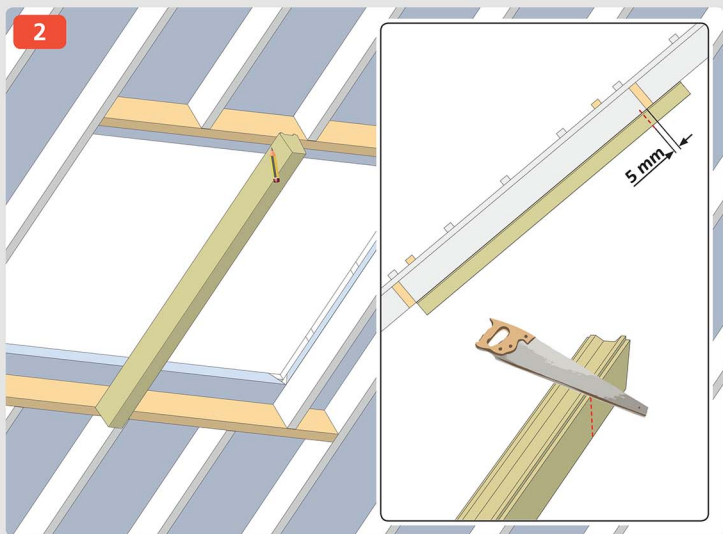
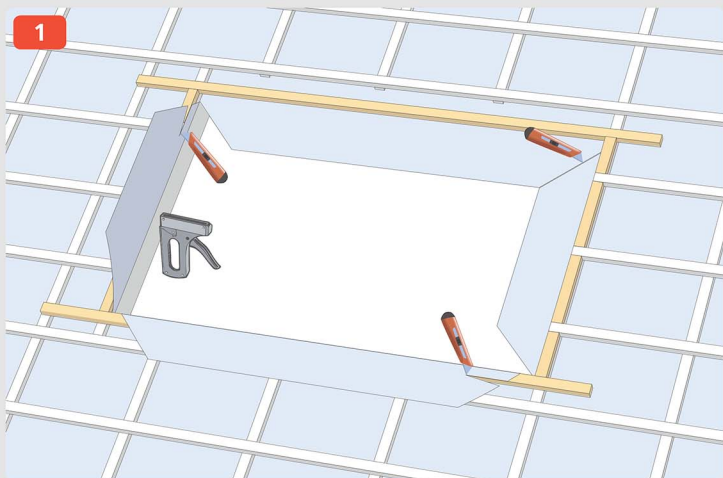

3

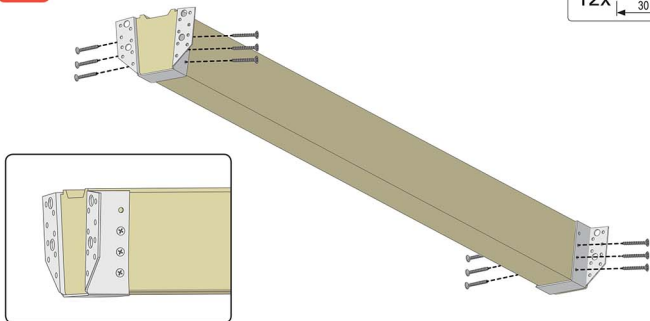
12x  30 mm

4

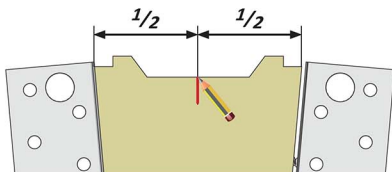

5

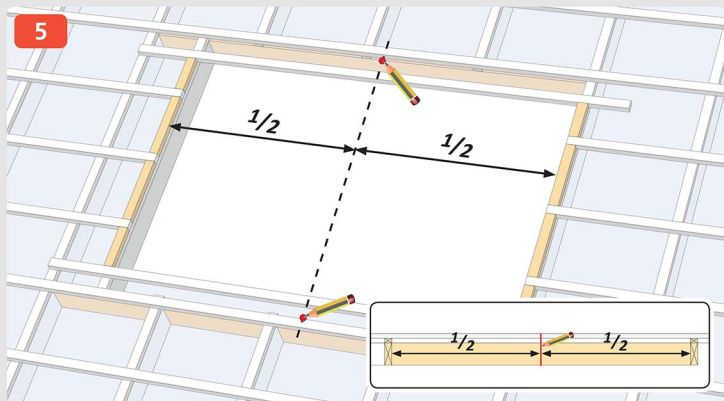

6

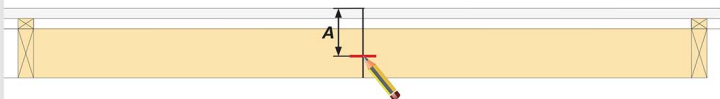

TRF



DTRF



PTRF

 $A = 60 \text{ mm}$ 

SRF

 $A = 67 \text{ mm}$

7

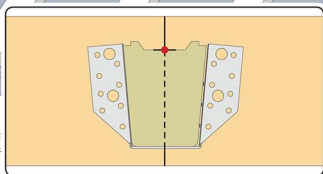
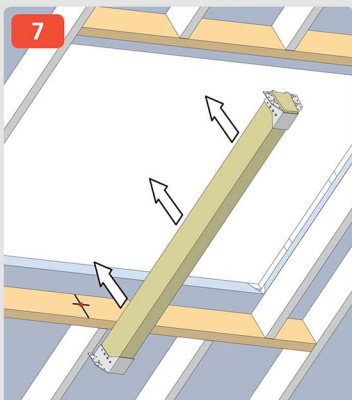

8

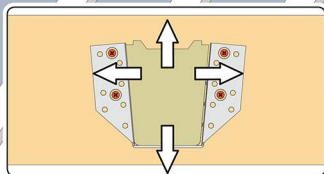
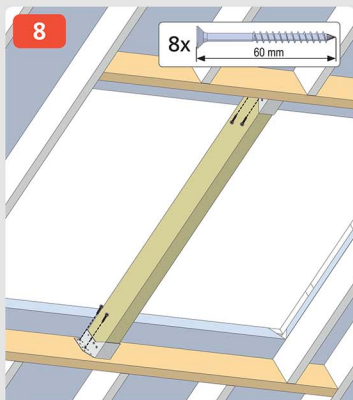

9

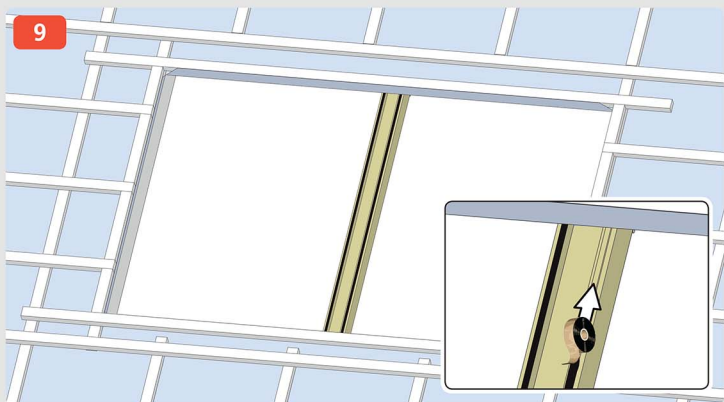

10

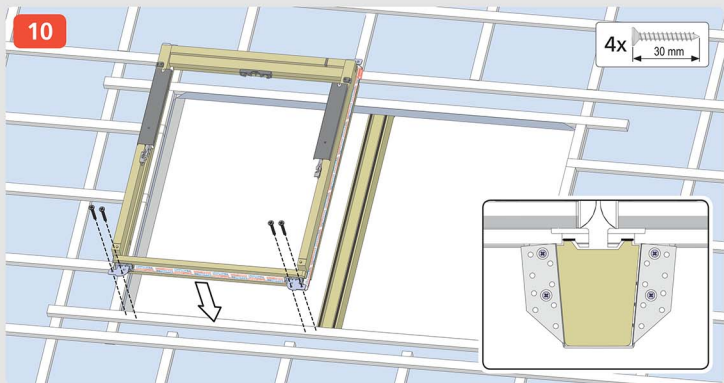

3 - 10 mm



5 - 10



10 - 15 mm



5 - 10



15 - 45 mm



45 - 90 mm



5 - 10



11

8x

30 mm

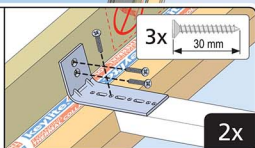
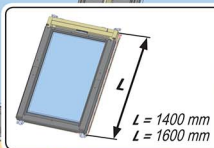
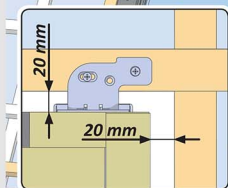

12

12x

60 mm

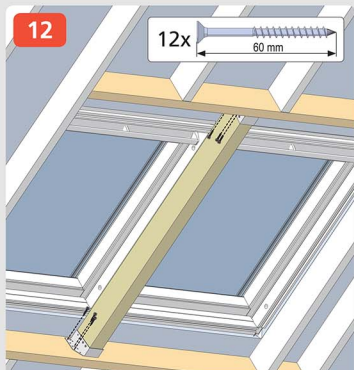

10 - ...

13

