

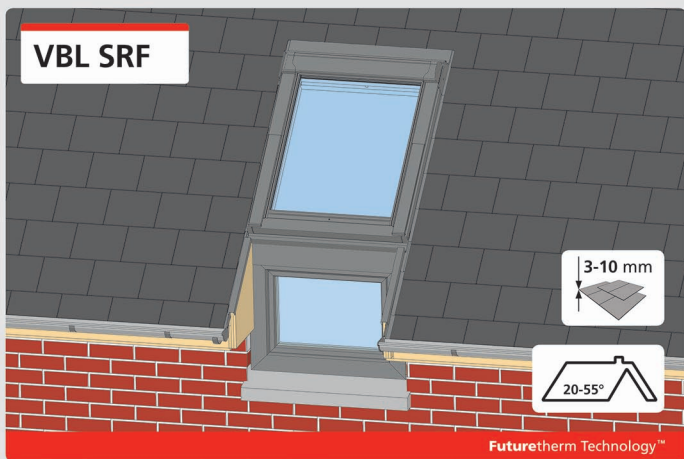

VBL SRF

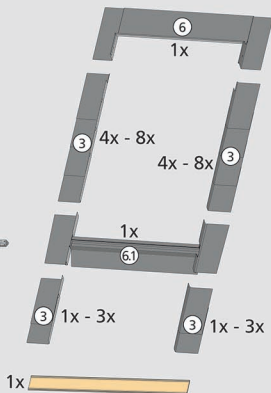

Futuretherm Technology™

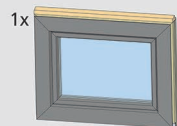
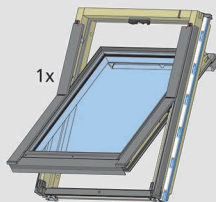

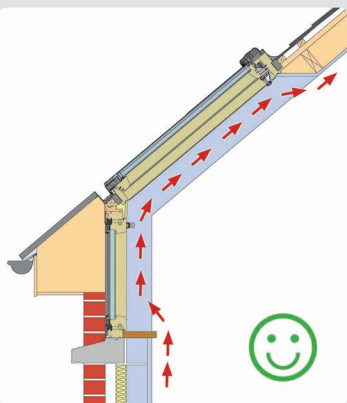
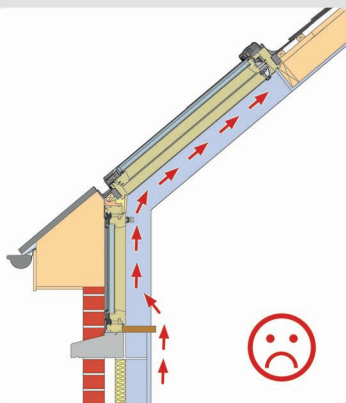
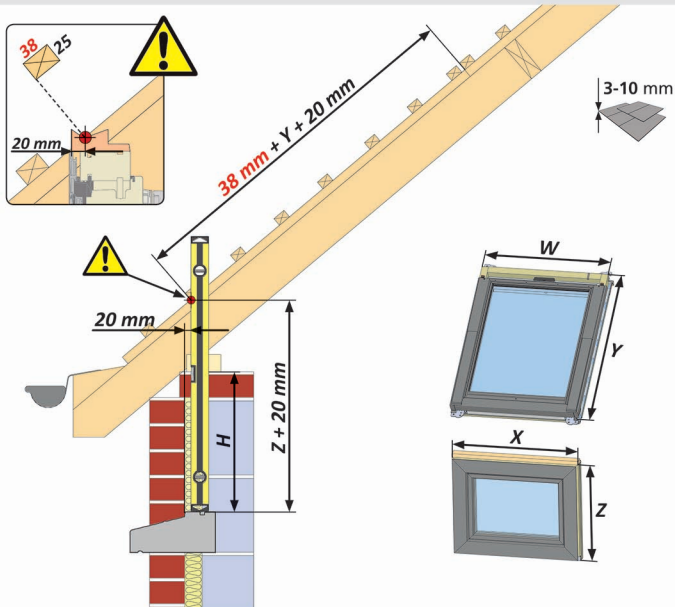

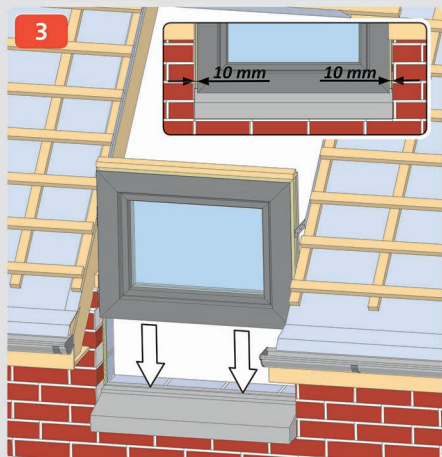
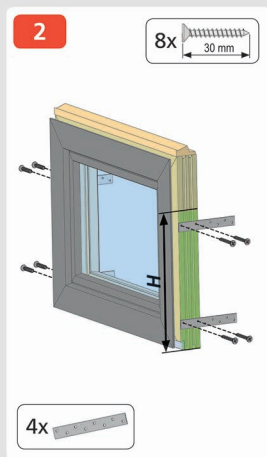
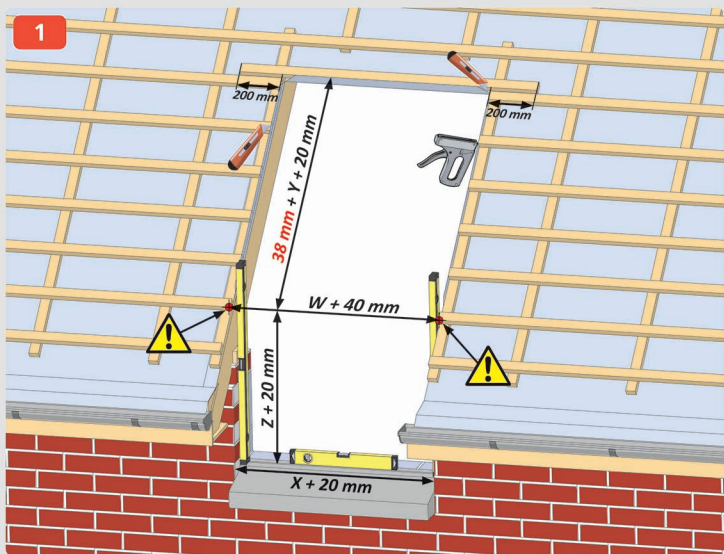

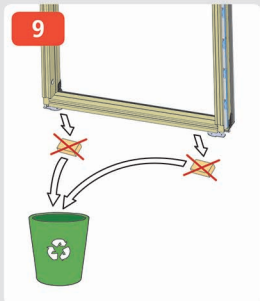
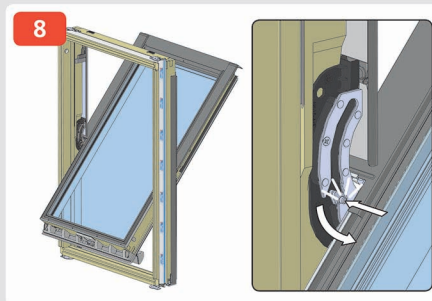
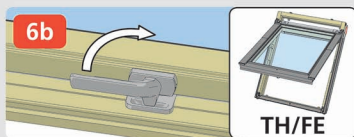
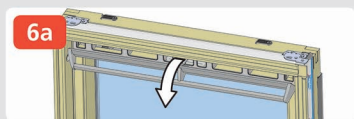
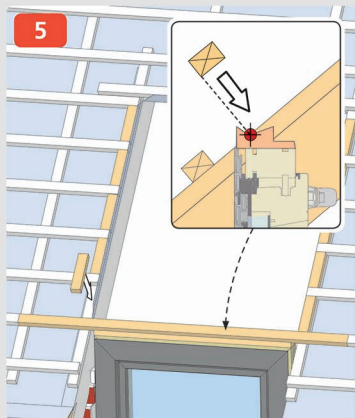
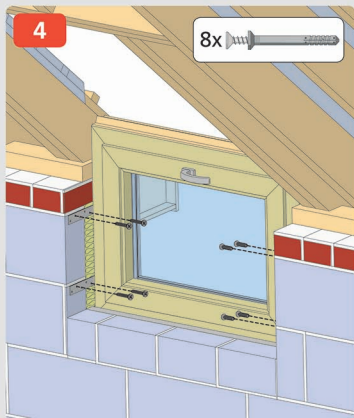

10

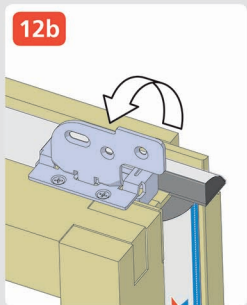
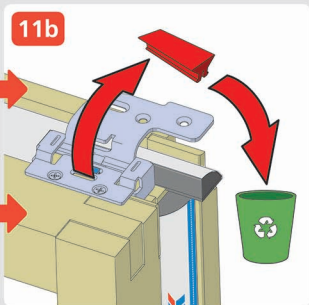
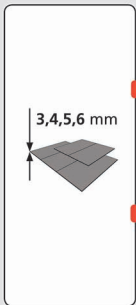
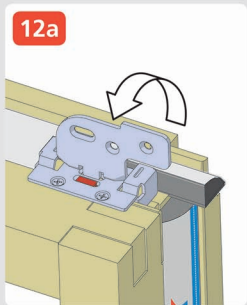
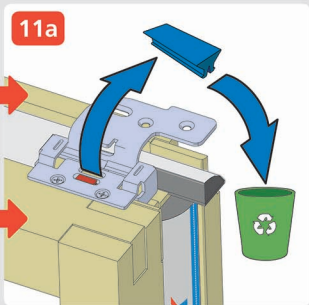
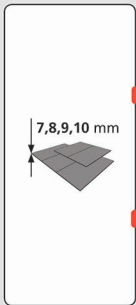
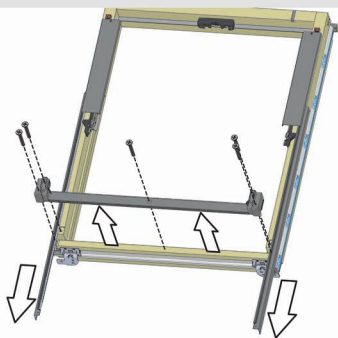

13

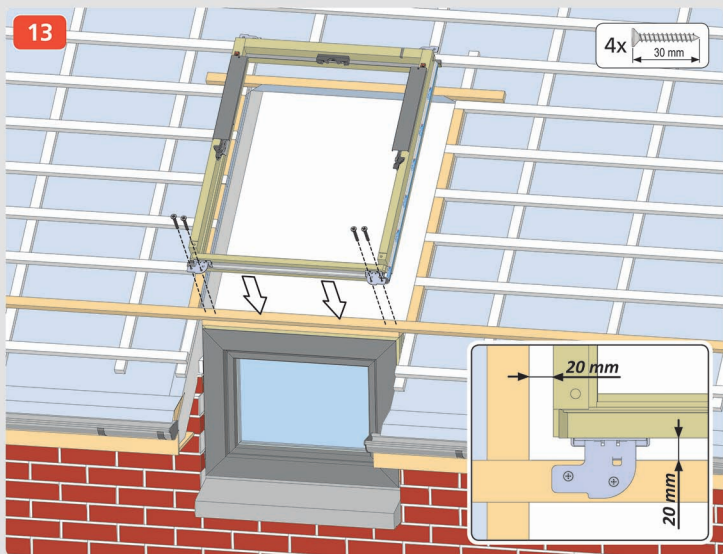

14

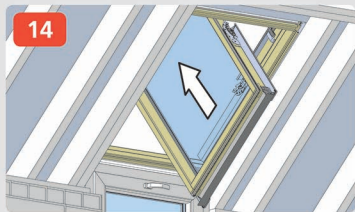

15

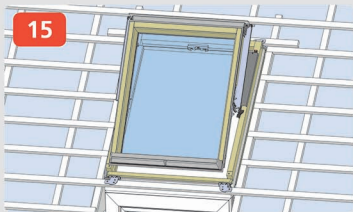

16

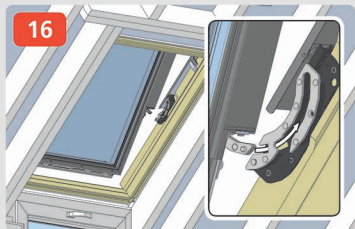

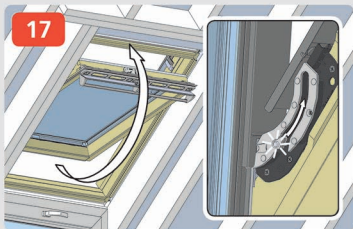

17

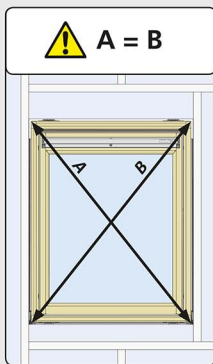
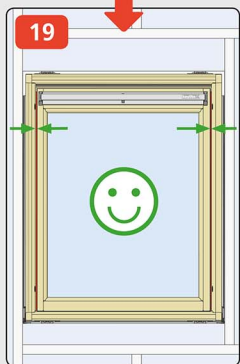
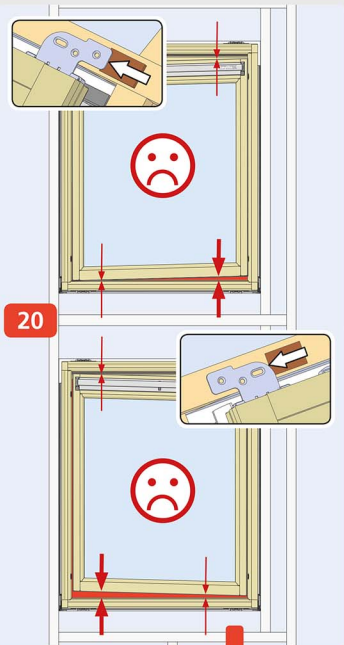
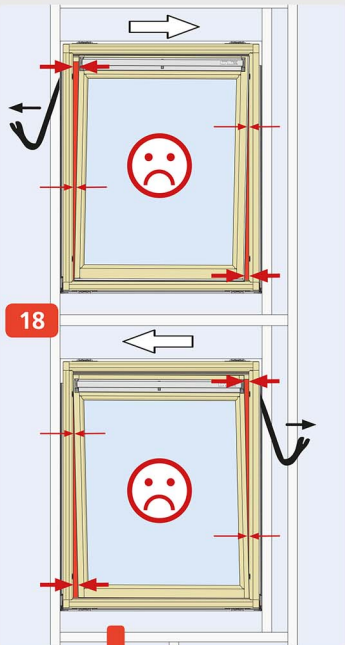

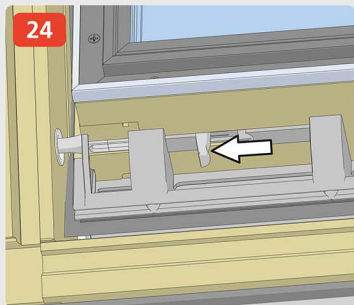
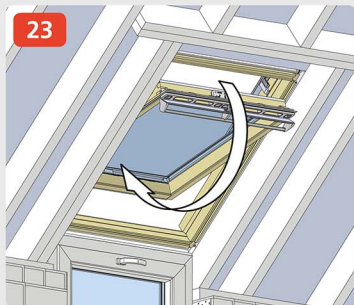
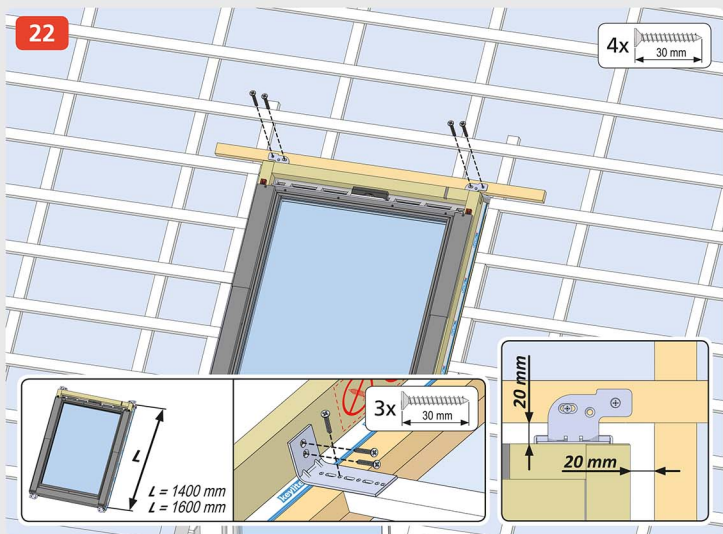

22

4x 

25

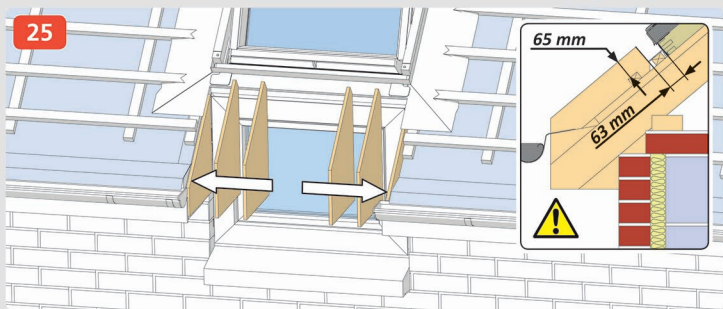

26

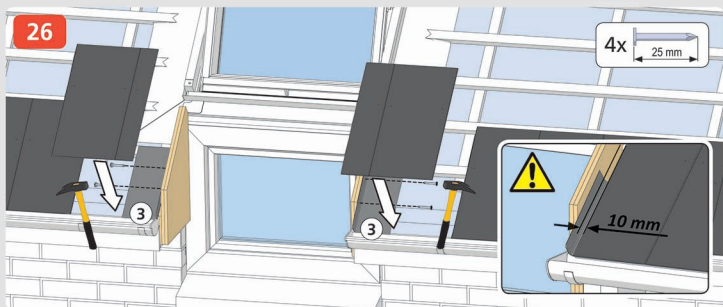

4x 25 mm

27

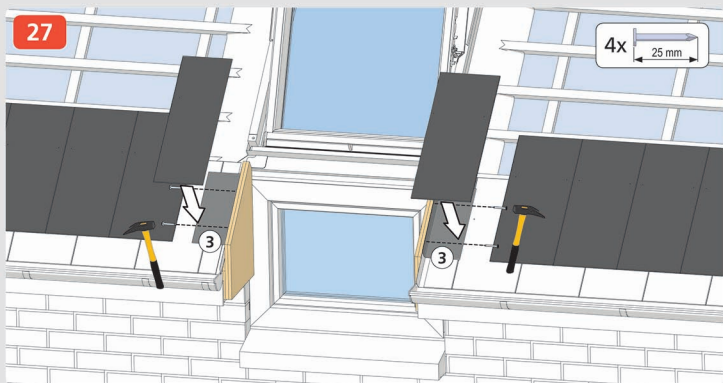

4x 25 mm

28

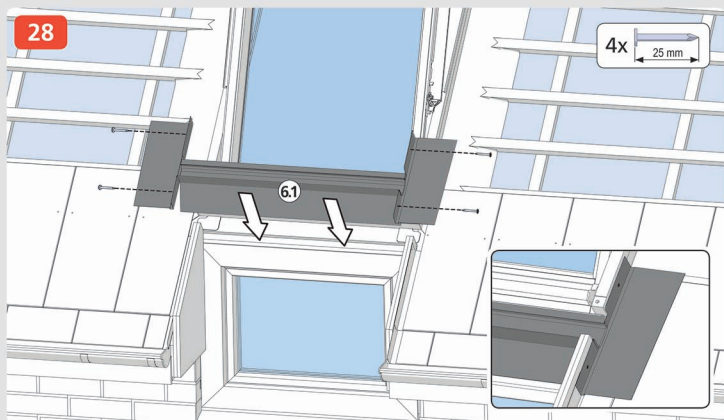

29

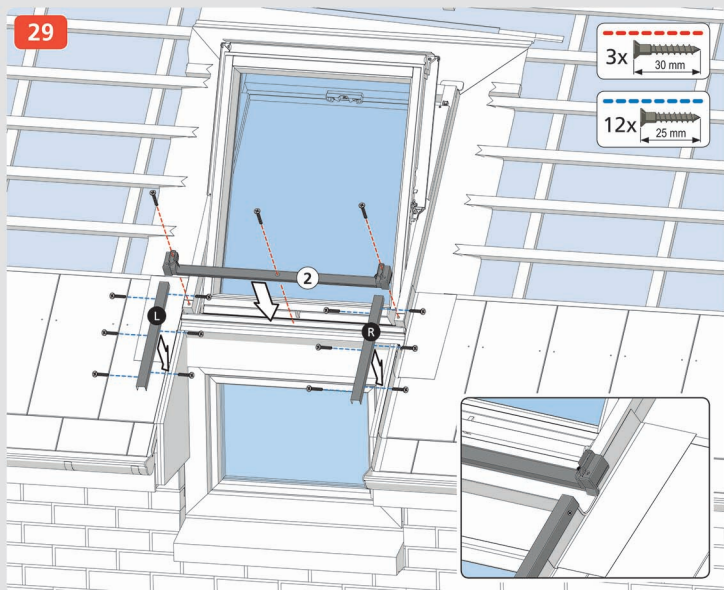



TH/FE



max.
7 mm



30

4x

25 mm



3



3

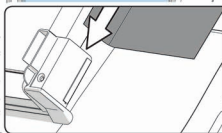

31

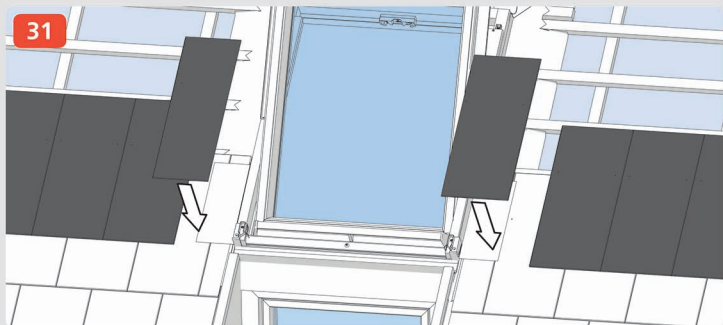

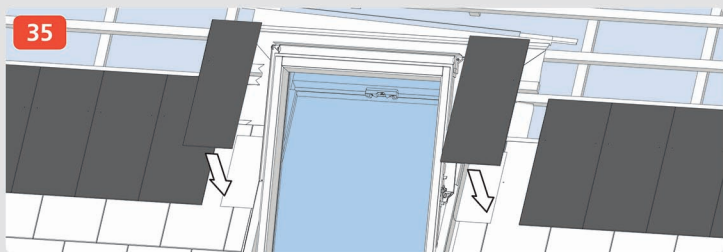
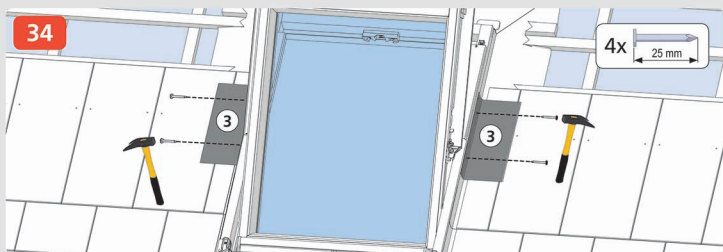
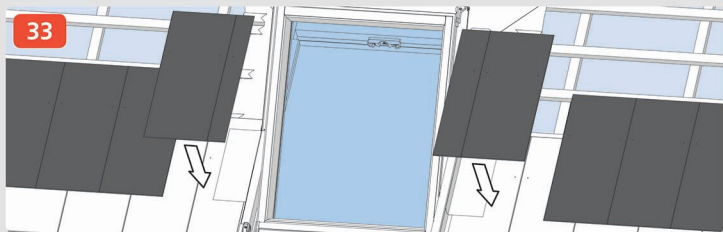
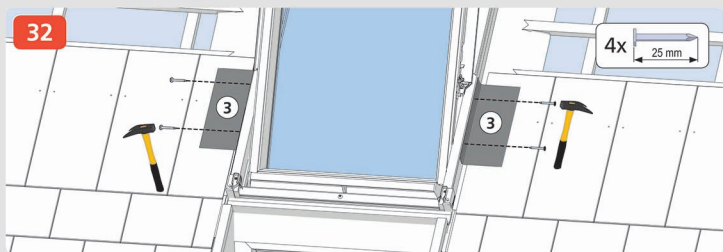

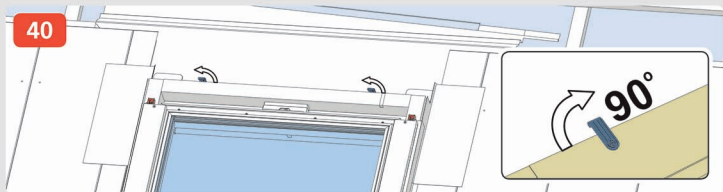
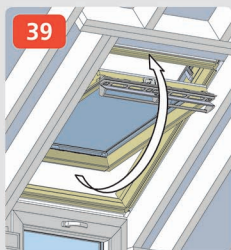
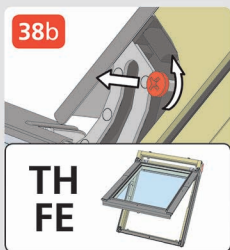
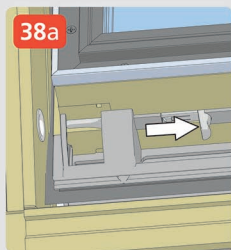
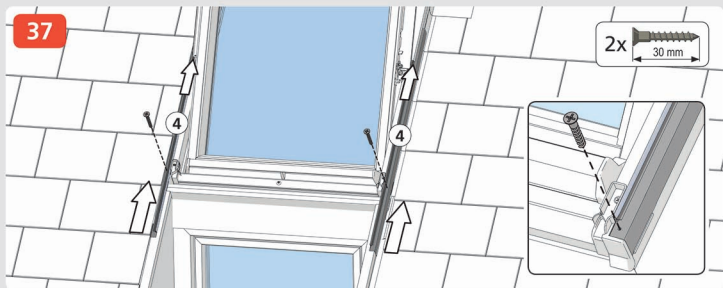
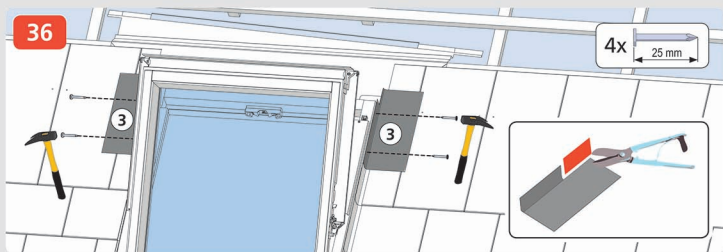

41a

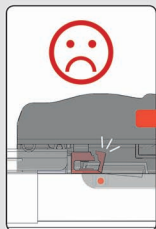
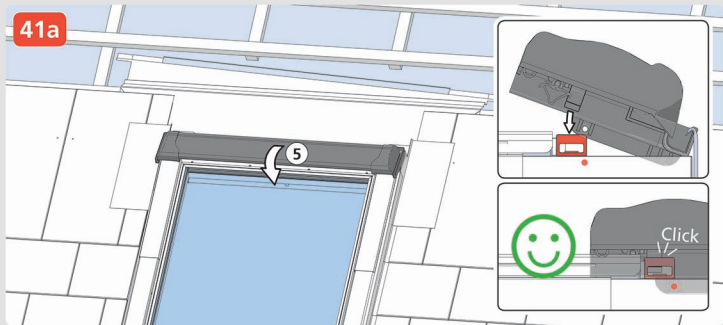

41b

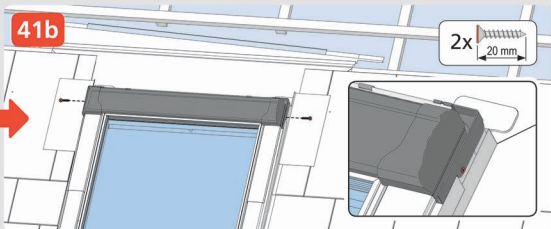

42

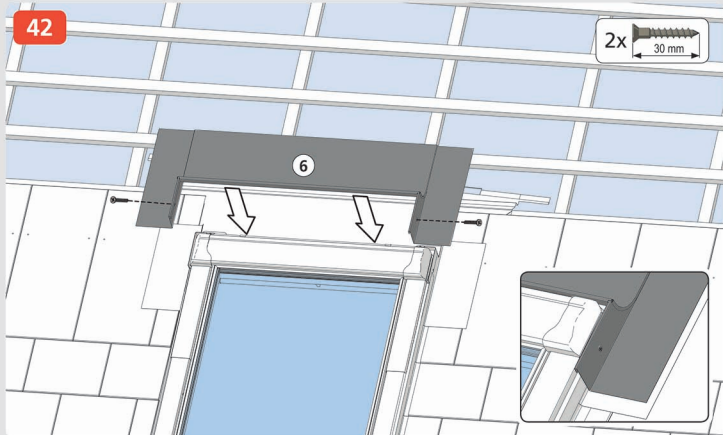

43

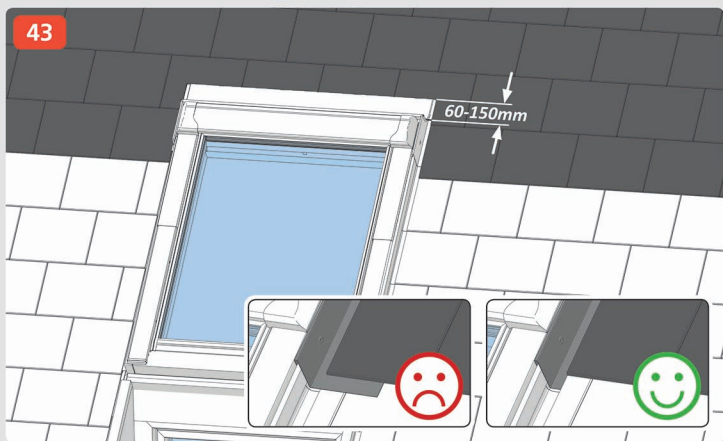

44

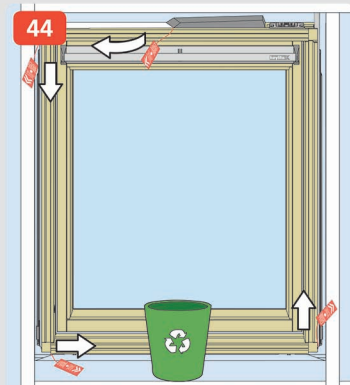

45

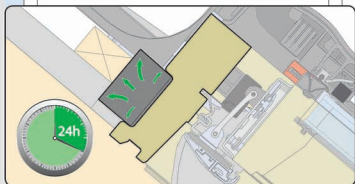
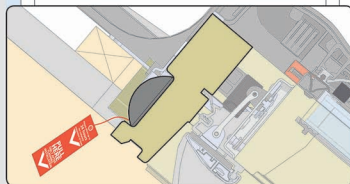
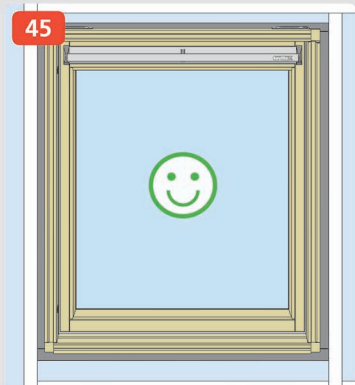

46

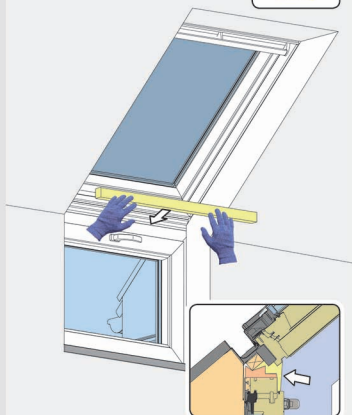

47

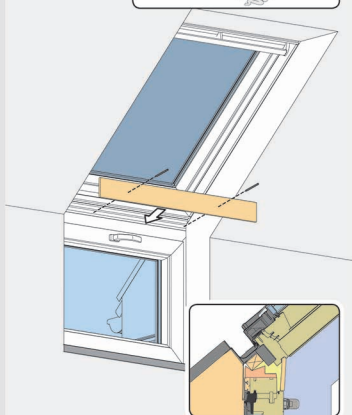

48

