

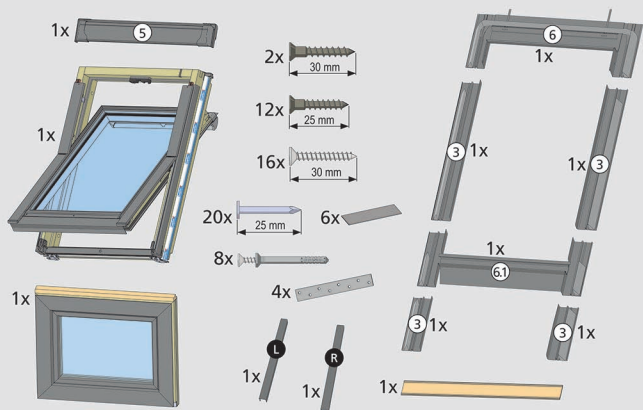

VBL TRF

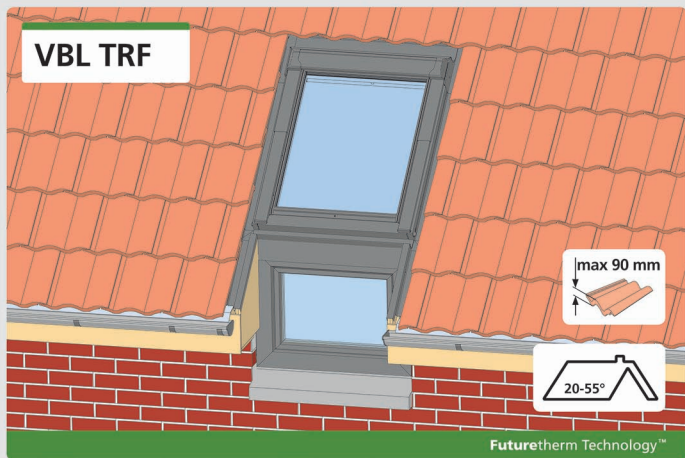

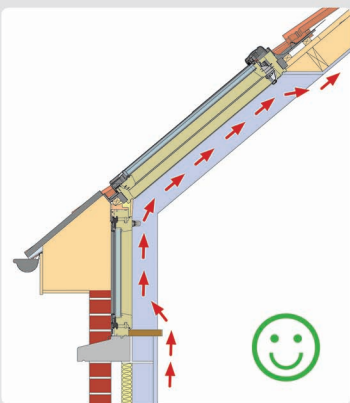

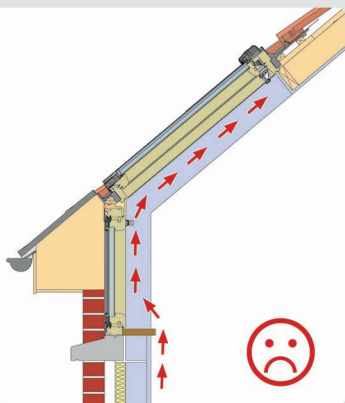
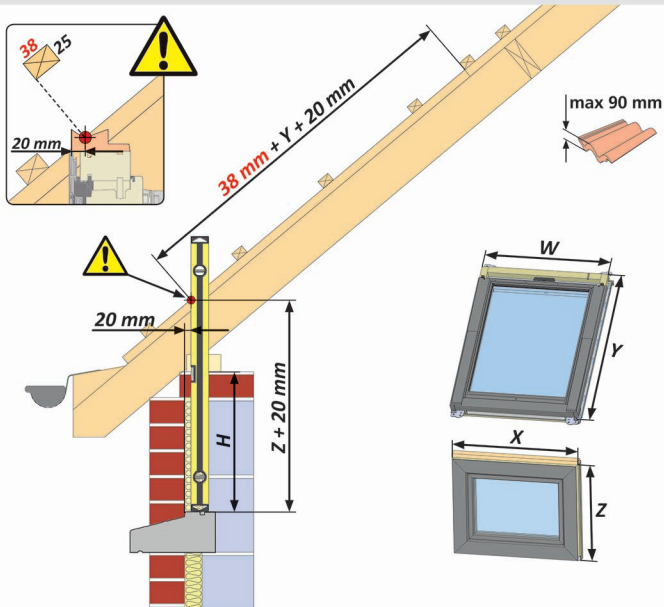
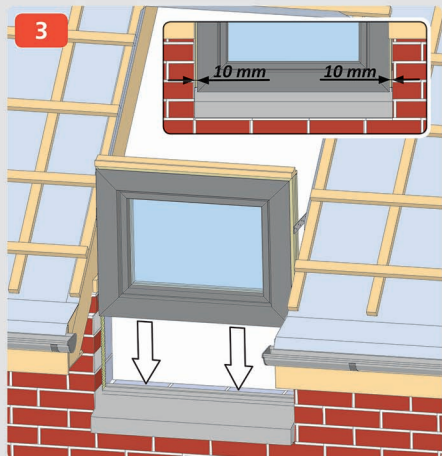
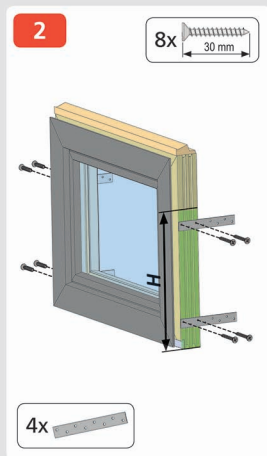
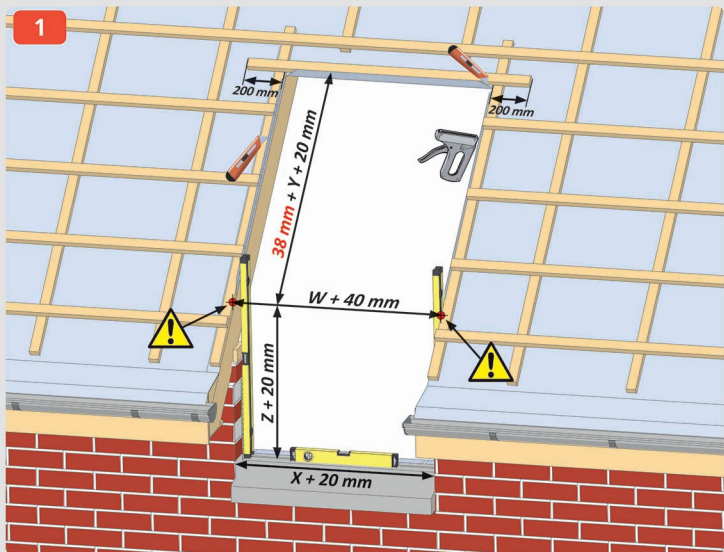

4

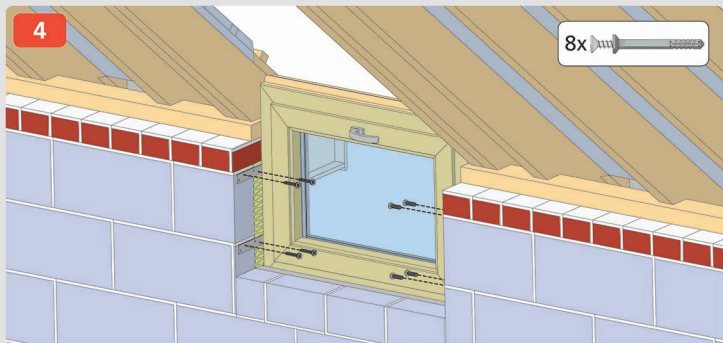
8x 

5

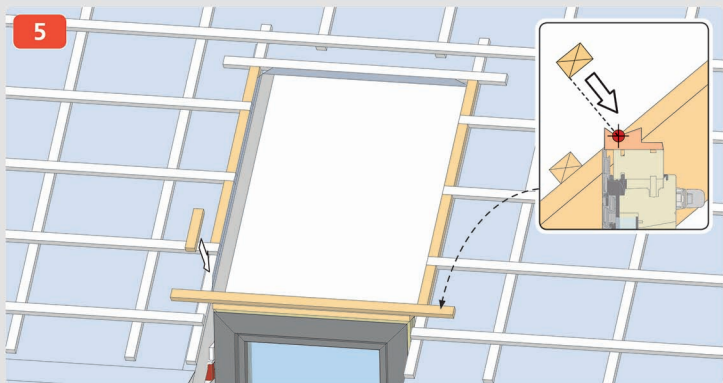

6a

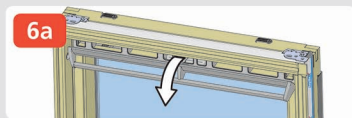

6b

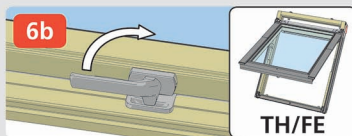

7



8

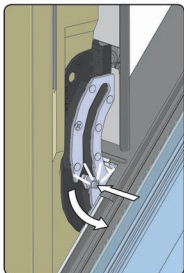

9

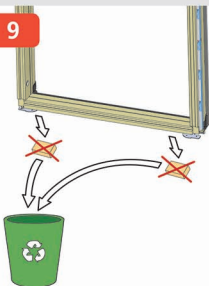

10

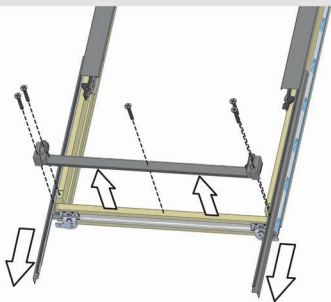

11

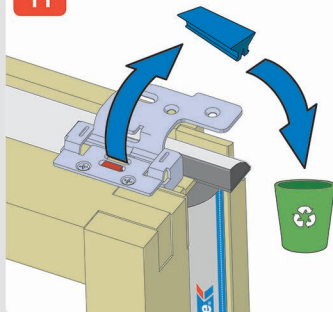

12

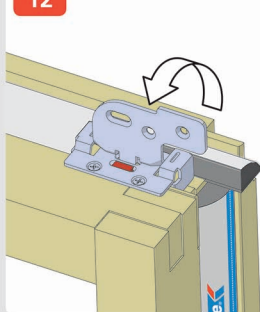

13

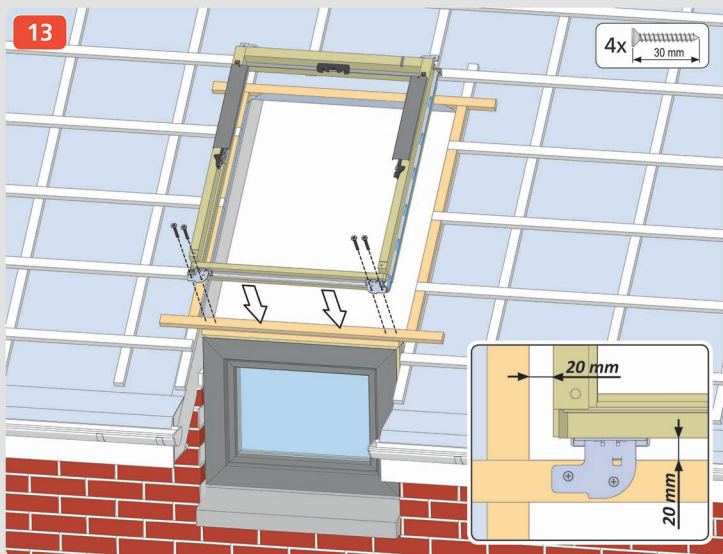

14

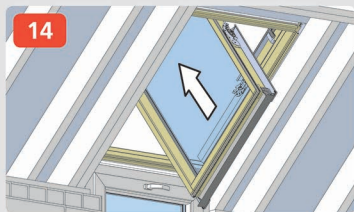

15

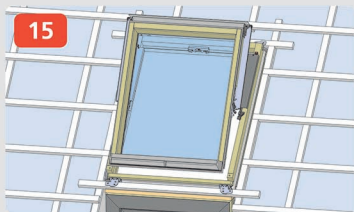

16

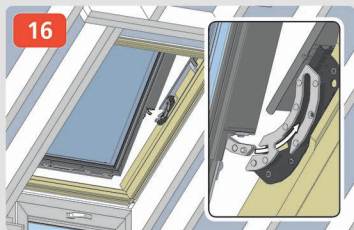

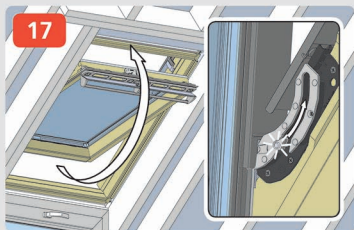

17

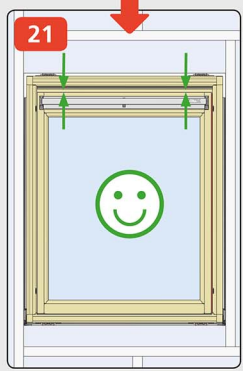
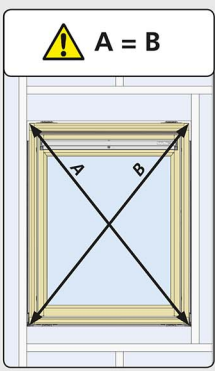
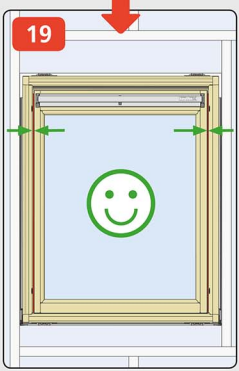
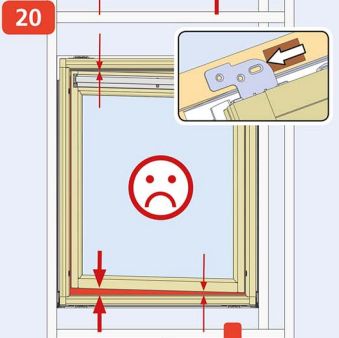
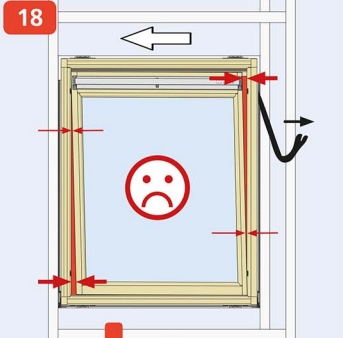
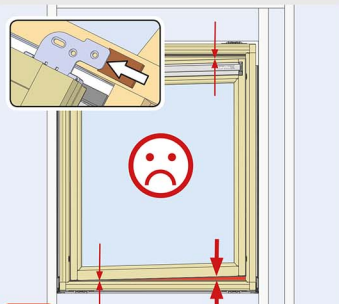
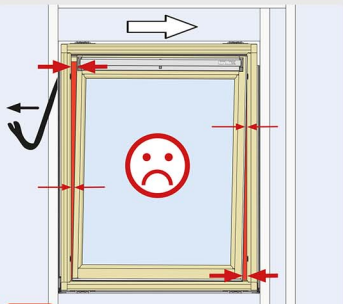

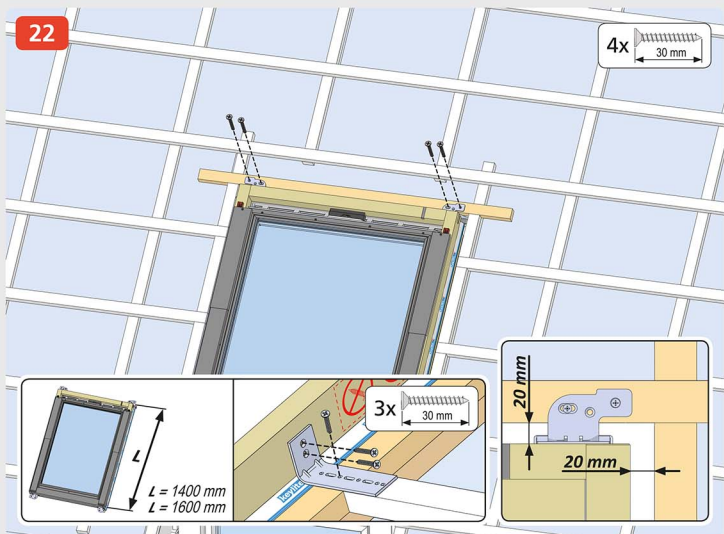

22

4x 

23

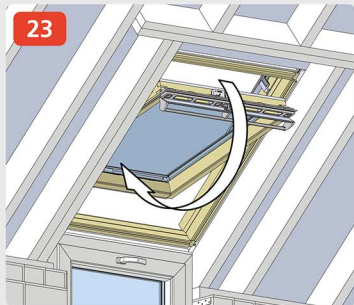

24

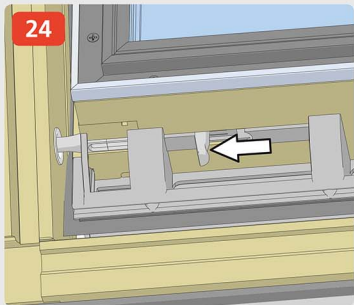

25

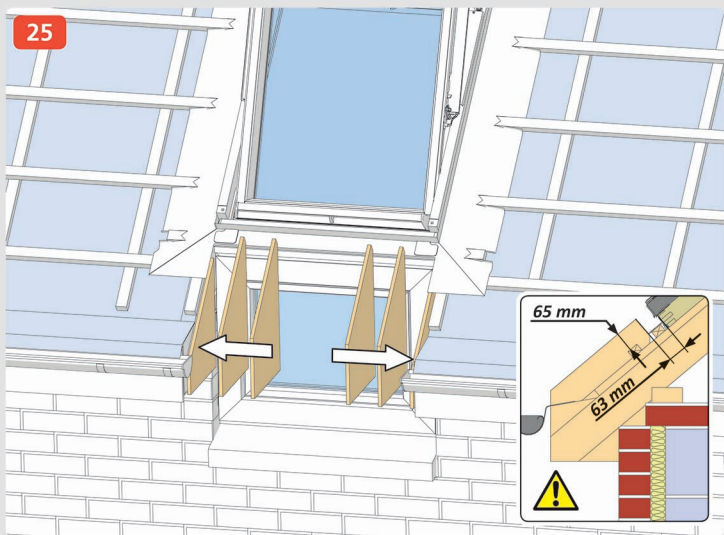

26

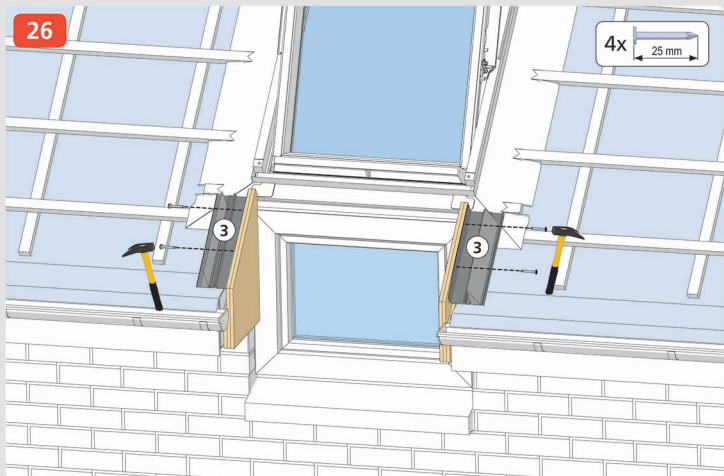

27

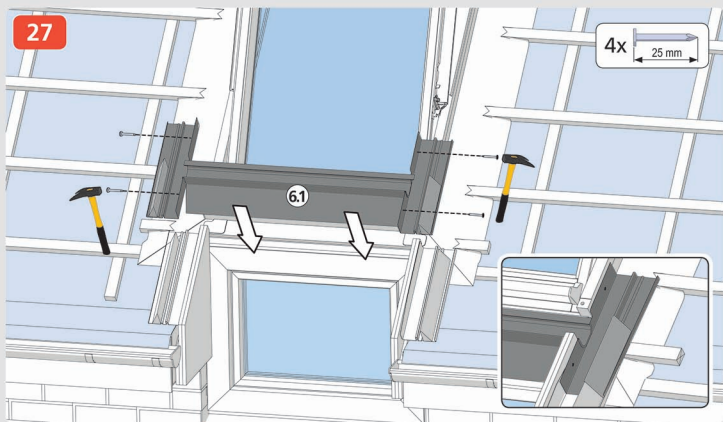

28

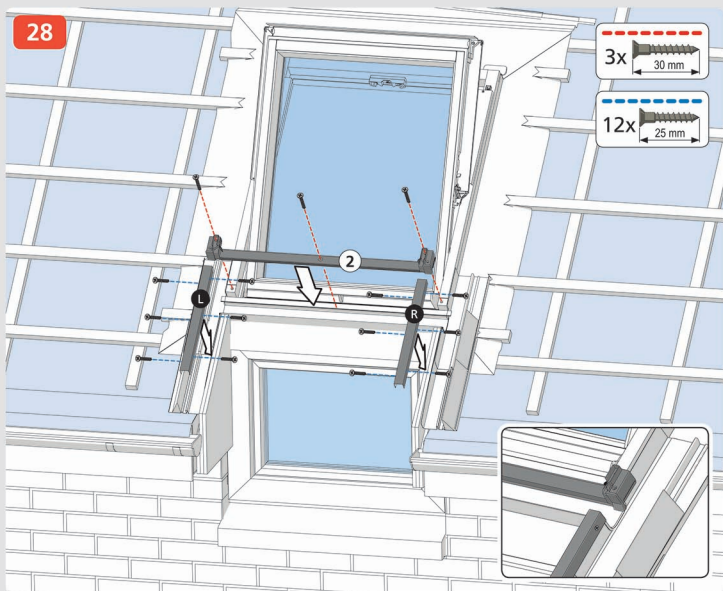



TH/FE



max.
7 mm



29

6x 25 mm

3

3



30

6x



6x



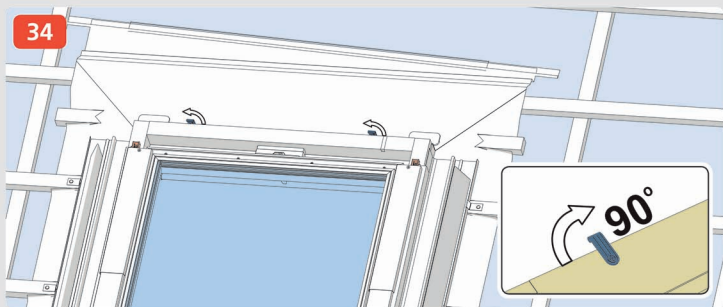
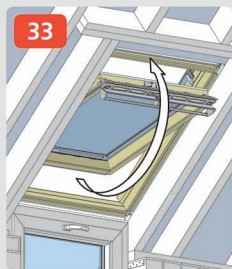
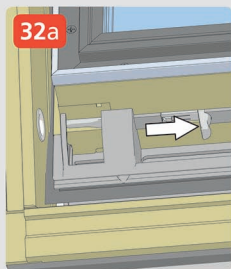
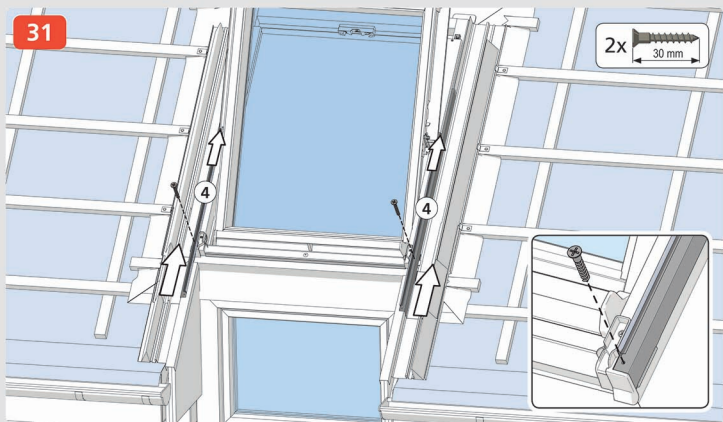

35a

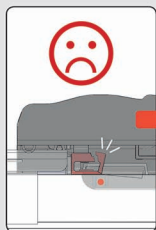
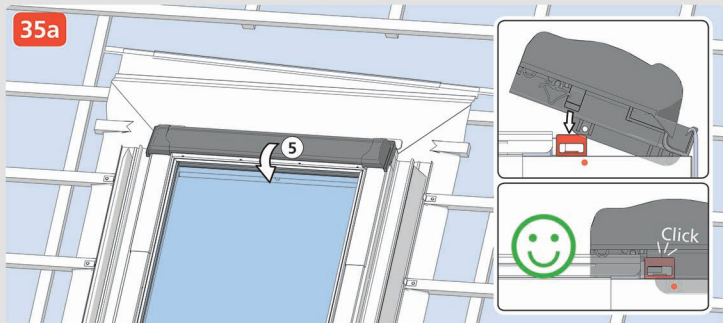

35b

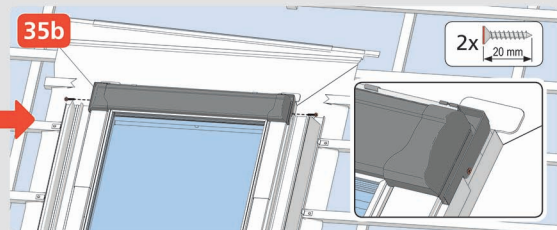

36

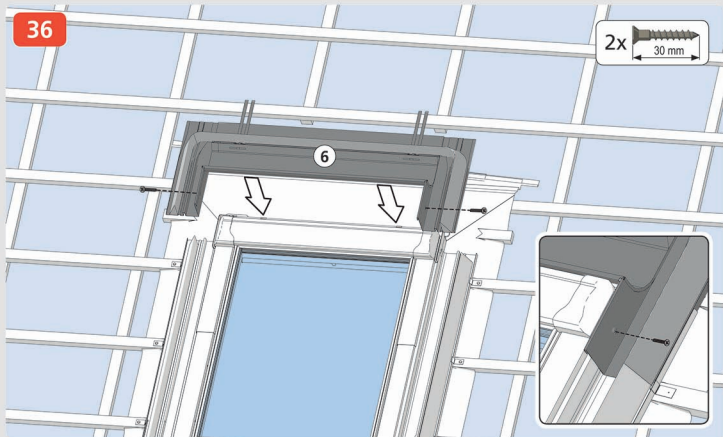

37

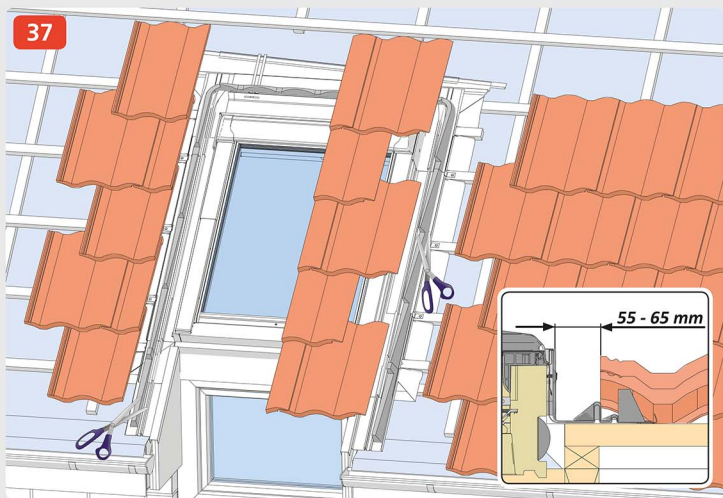

38

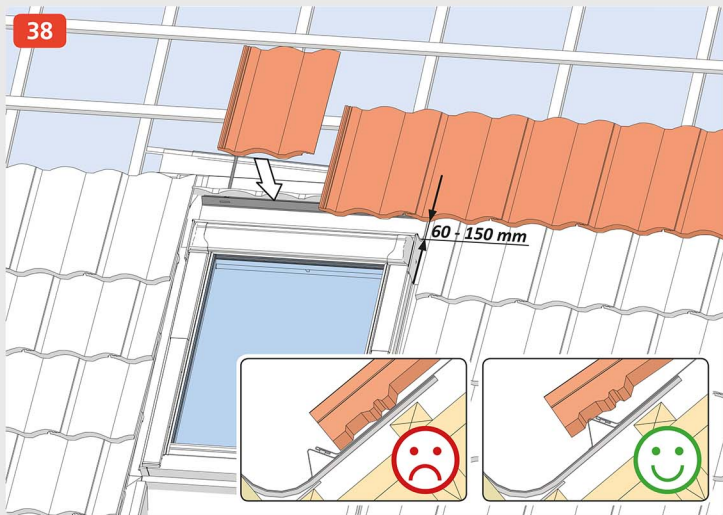

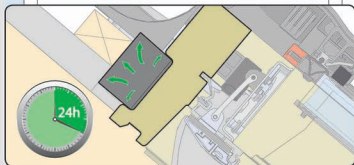
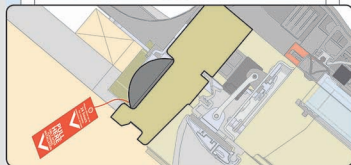
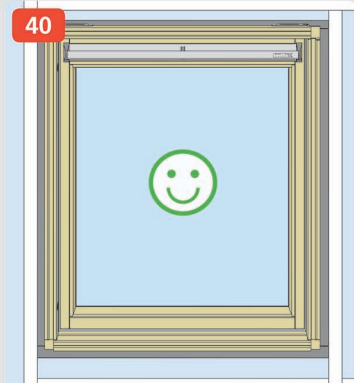
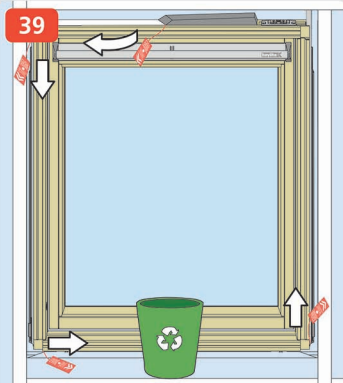

41

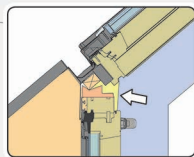
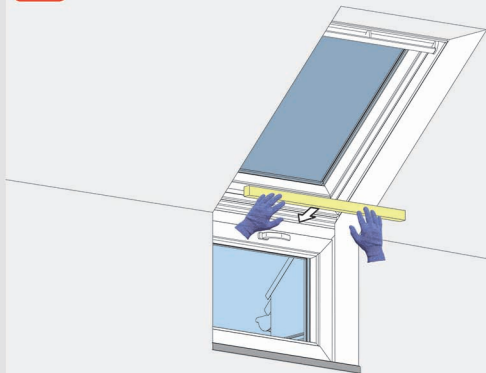

42

2x

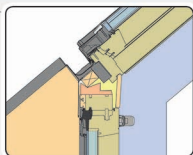
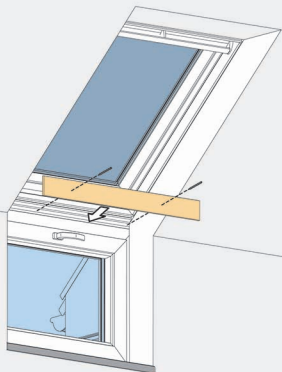

43

