

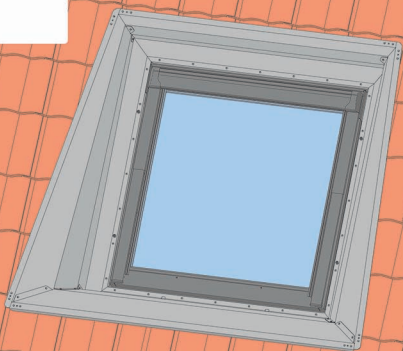

WD

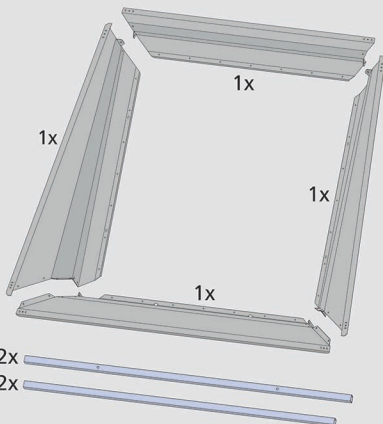

Wind Deflector

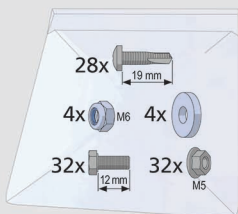

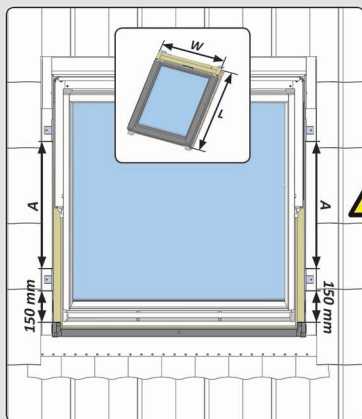
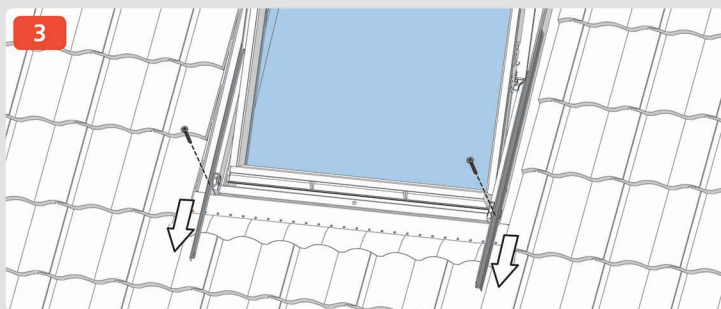
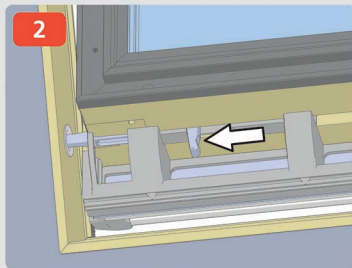
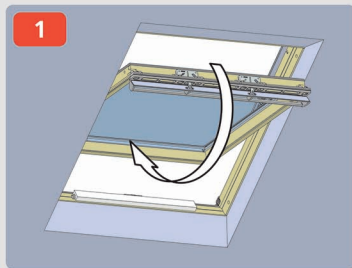

	<b>W x L</b>	<b>A</b>
CP 08	1180 x 1140 mm	570 mm
CP 10	1400 x 1340 mm	790 mm

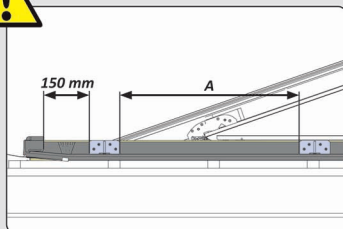

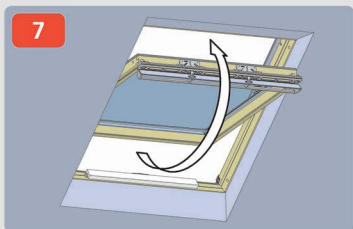
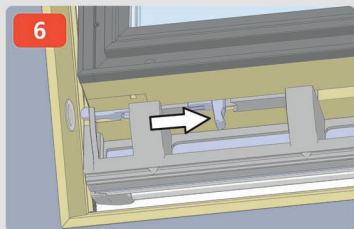
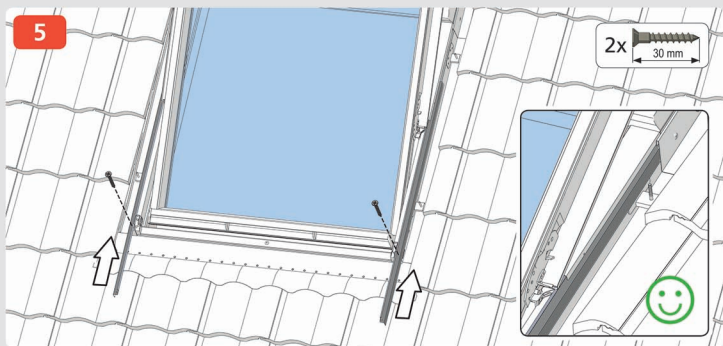
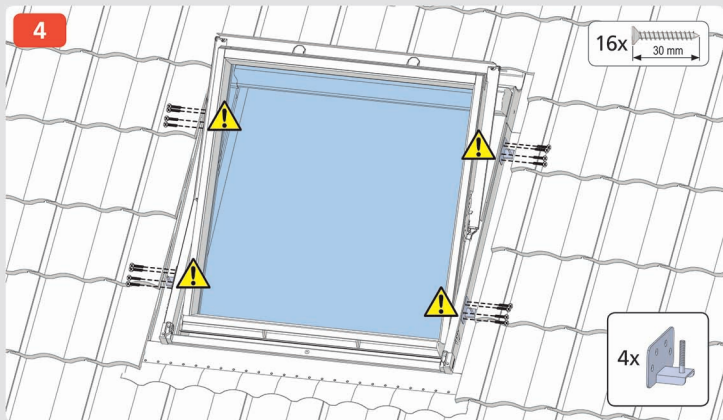

8

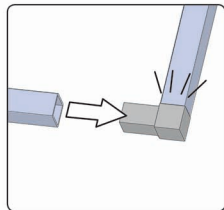
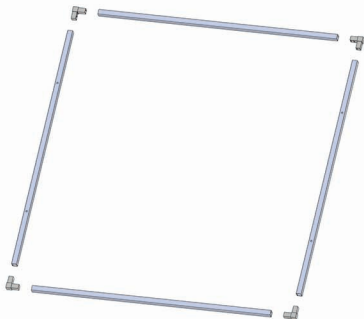

9

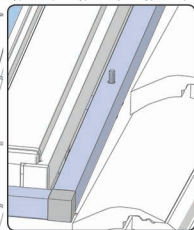
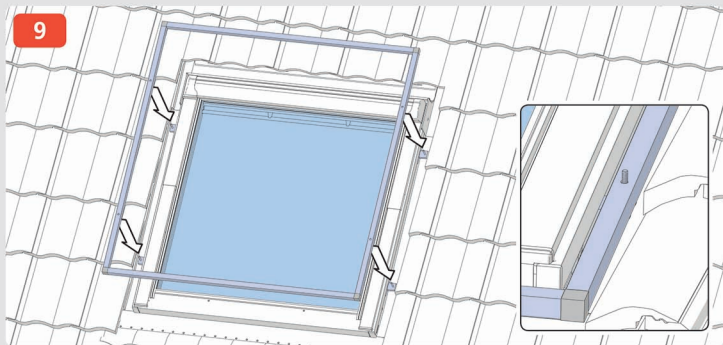

10

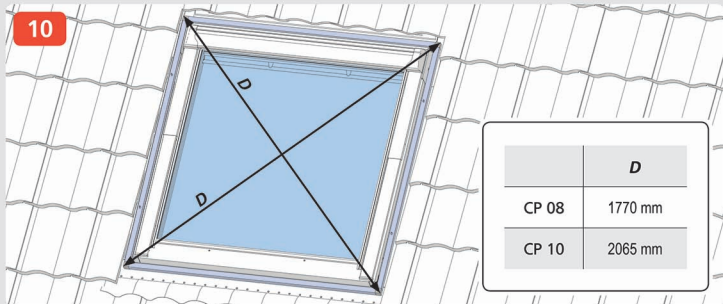

	<i>D</i>
CP 08	1770 mm
CP 10	2065 mm

11

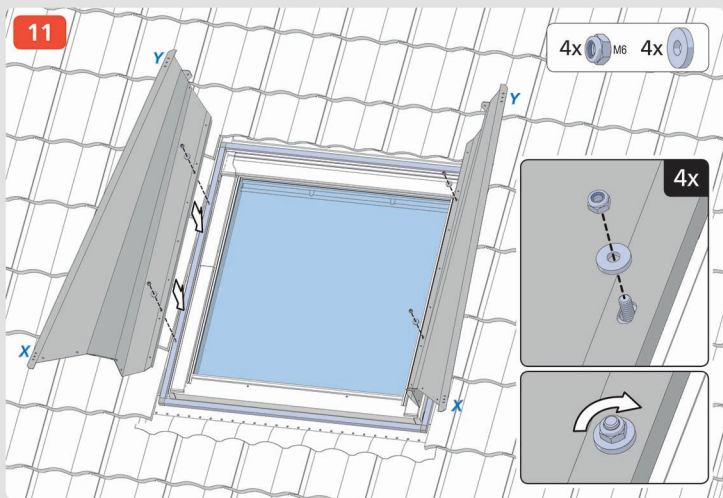

12

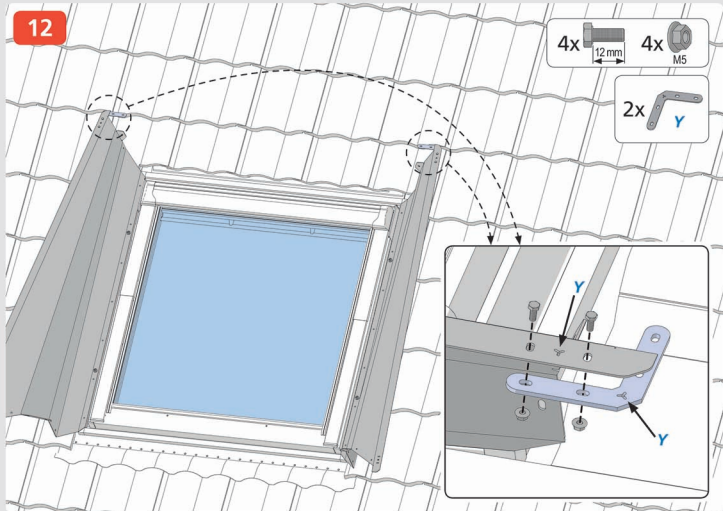

13

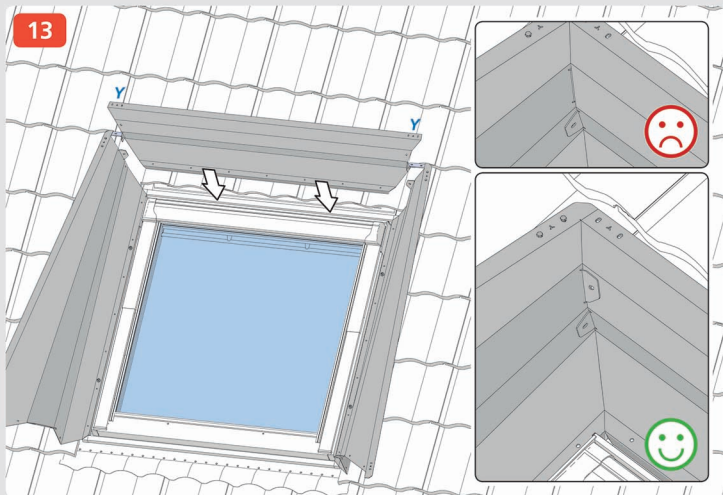

14

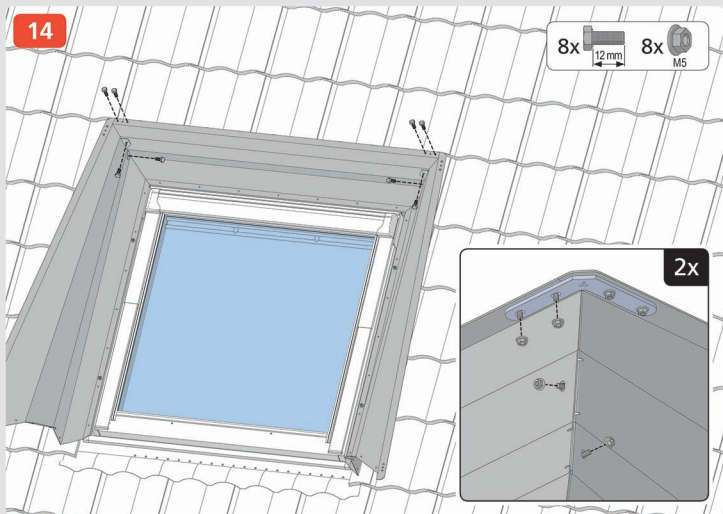

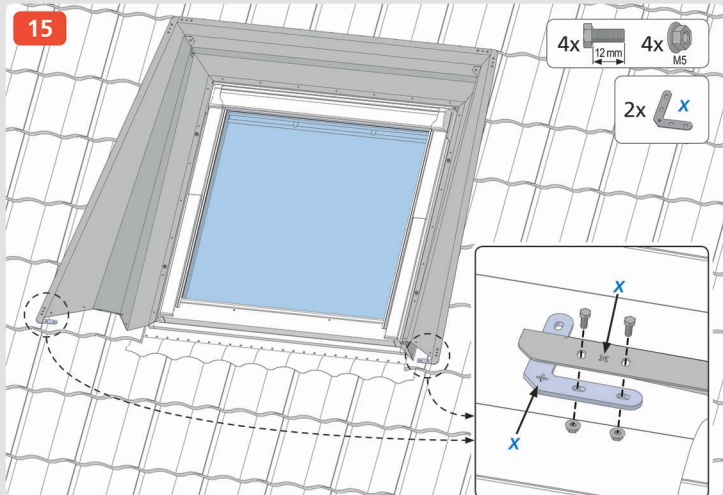

15

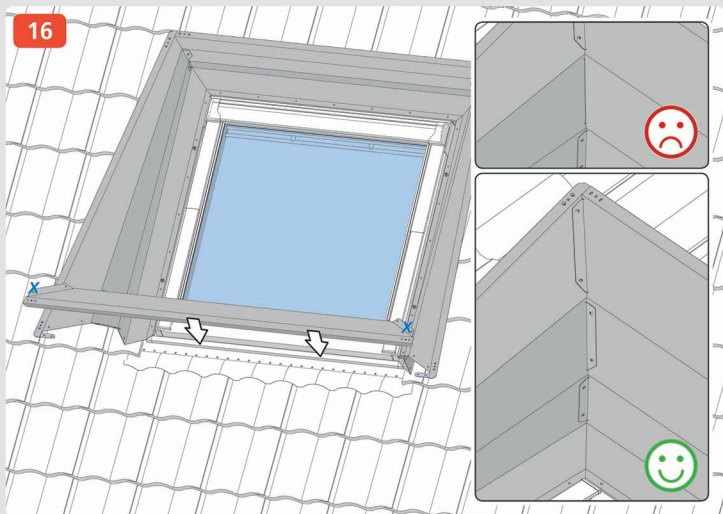

16



17

16x  12mm 16x  M5

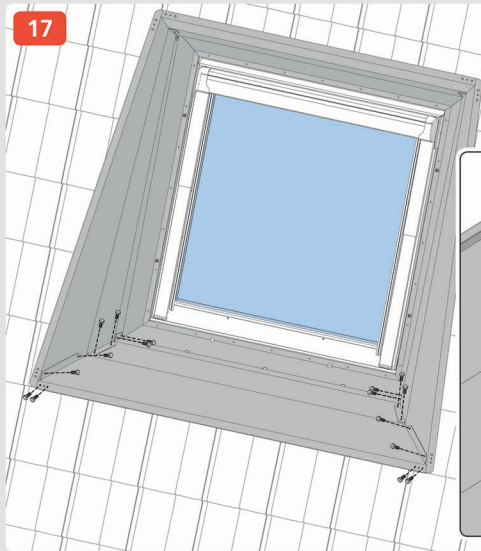

2x

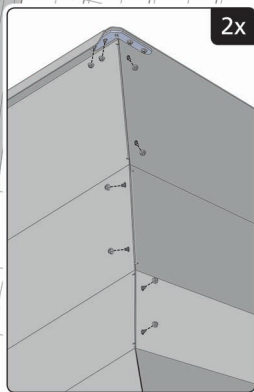

18

28x  19mm

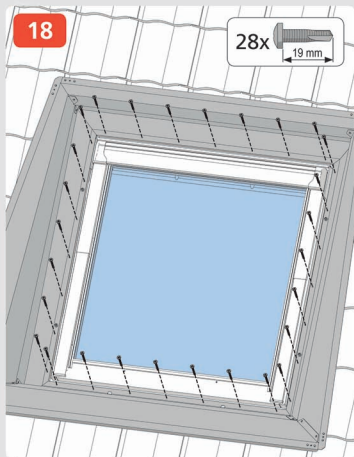

19

