

**keylite**®

Roof Windows



**Futuretherm  
Technology™**

## INNOVATION

- 04 Why Keylite?
- 06 Key Features
- 08 **Futuretherm Technology<sup>™</sup>** New  
Integrated Thermal Collar
- 10 Flick-Fit Bracket
- 12 Faster, Lower, Warmer

## CHOICE

- 18 Natural Light For Every Room
- 20 Product Selector
- 22 A Brighter Day
- 24 Power Up Electric
- 26 Energy Efficient Glazing
- 28 Clever Integral Blind
- 30 Colour With Blinds
- 32 Make It White

## ROOF WINDOW RANGE

- 34 Centre Pivot
- 36 Fire Escape/Top Hung
- 38 Conservation
- 40 Combination Window Options
- 42 Vertical Bi-Lite Window System
- 44 Ridge Window
- 45 Flat Roof Apex System
- 46 Flat Roof System
- 47 Combi Flat Roof System
- 48 Flat Roof Dome
- 49 Flat Roof Access Hatch
- 50 Flat Roof Smoke Ventilation
- 51 Smoke Ventilation
- 52 Sun Lite<sup>™</sup> Light Tube

## BLINDS

- 54 Genuine Keylite Blinds

New  
Range

## FLASHINGS & ACCESSORIES

- 58 Single Window Flashings
- 59 Combination Flashings
- 60 Enhanced Installation Components
- 61 Accessories
- 62 Loft Ladder
- 64 Roof Window Support Trims
- 65 Service & Support
  
- 66 Installation Instructions
- 67 Window Sizes & Product Codes



**Natural daylight** has the unique ability to transform interiors into vibrant spaces that are enticing, bright and warm.

Combined with natural ventilation, this free resource creates healthy and happy environments for work, rest or play.



# Why Keylite?

“ Not all windows are equal... only Keylite has patented Flick-Fit technology ”



## Extra performance, no extra costs

Keylite offers all its great features as standard, where other roof windows may require the use of additional cost accessories, just to achieve the same performance as Keylite.

### Better Value!

- ✓ Free Expanding Thermal Collar
- ✓ Recessed Fit as Standard
- ✓ Warm Edge Glazing as Standard



## Proven design, quality materials

Keylite is part of a leading UK building materials producer which has over 30 years experience in the design and manufacture of high performance building materials for the UK and European markets.

All our timber is 100% FSC® certified from well managed forests and other controlled sources, so you can be assured of our responsible environmental credentials.



## Patented innovation

Keylite's innovation guarantees that our products' performance is unique.

Our patents mean that other conventional roof windows do not share many of our extraordinary features, all of which are designed to enhance performance and simplify the installation, operation and maintenance of our products.



## 10 Year guarantee

Keylite Roof Windows and Flashings are covered by a 10 year guarantee.

We are confident that our products will give trouble free performance throughout this period and beyond.

All electric components, blinds and accessories are covered by a 3 year guarantee.



## Service

Keylite's technical experts are on hand to advise and assist you at the design and specification stage.

When it comes to supply and delivery, our merchant stockists are at your service.

We are also available for supply of blinds and after-sales service at the contact points printed at the back of this brochure.



## Approved

We take time to seek and win approval from relevant national bodies for both the company and our products. Our third party certifications give you the confidence that Keylite is the correct choice for your project.



British Standards Institution



Compliance with EU legislation



BBA Certification For Centre Pivot Windows



National Building Specification Approved



The mark of responsible forestry



Rainforest Alliance Certified™

# Key Features

## Expanding Thermal Collar

Simply pull away the release tape to allow our unique **Expanding Thermal Collar** to expand, filling the gap between the window frame and the roof: A proven measure in reducing the cold bridging effect.



## Ventilation Handle

Our slimline ventilation handle has a new **contemporary style**, designed to provide comfortable opening of both the window and ventilation flap. The handle allows for trickle ventilation, even with the window fully closed and securely locked.



## Maintenance Free Hinge

The hinge, being the most **vital component** of the window, is the only operational part that moves. Keylite has eliminated the maintenance requirement of this component.



## Sash Hinge Finger Springs

The sash hinge finger spring allows the sash to be installed back into the frame in one smooth, **effortless** motion.



## Flick-Fit Brackets

Pre-fitted Flick-Fit brackets are easy to use and make Keylite **faster** from the box to the roof.



## Click-Fit Hood & Cover Flashings

Simply **click the hood** under the clips and secure. The cover flashings now require 50% fewer screws than before.



## Streamlined Fit

Allowing the window to sit lower in the roof, the hood is designed to create a low profile



## All Weather Ventilation

Keylite Roof Windows all provide trickle ventilation, even with the window fully closed and securely locked.

### Ventilation filter

The built-in insect filter ensures only clean, fresh air passes into the room.



## Warm Edge Glazing

All glazing is now upgraded as standard to warm edge, which **adds protection** against condensation.

# Innovation

The 2015 Keylite range with **Futuretherm Technology™** is the result of a 100% focus on innovation.

Enhancements throughout our new roof window make installation even easier than before and improve the overall user experience.

Our new **Expanding Thermal Collar** is a unique intergrated solution, combating the cold bridging effect and reducing heat loss.

Keylite is the **only** roof window with a built-in device which completely closes the gap between the roof and the window frame, for better thermal performance. All other roof windows require a secondary fix to achieve this.



**Expanding Thermal Collar**

The 2015 range with **Futuretherm Technology™**

- Faster**
- Lower**
- Warmer**

# Flick-Fit

Our Flick-Fit brackets are pre-fitted to the window, making them fast and easy to secure into the prepared roof opening.

Further unique Keylite innovations will assist you to complete the subsequent flashing and insulation process.



# Simple, Easy... Fast

From box to roof in **2 minutes**



**Start**



Simply slip the window out of the box and remove the packaging.



**Flick** the pre-fitted brackets at the bottom of the window into place, selecting the setting for tile or slate roofs.



**Position** the window in the prepared roof opening, resting the Flick-Fit brackets on the bottom lathe. A projecting spur on the bracket ensures the window is set at the correct height.



**Pivot** the window through the roof opening and **flick** the top brackets into place, selecting the setting for tile or slate roofs. Secure the window with screws provided.

**Finish**

You are now ready to start the flashing process. ▶

**Faster**

New innovations combine for **faster, easier** installation.



**Flick-Fit Brackets**

Our unique Flick-Fit brackets are pre-fitted so you can lift the window straight from the box to the roof and simply select the setting for tile or slate.

- ▶ No loose brackets or screws.
- ▶ Fast fitting from the box to the roof.



**Click-Fit Hood**

Simply click the hood under the clips and secure. The Cover Flashings now require 50% fewer screws than before.

- ▶ 50% fewer screws.
- ▶ Faster and easier than before.

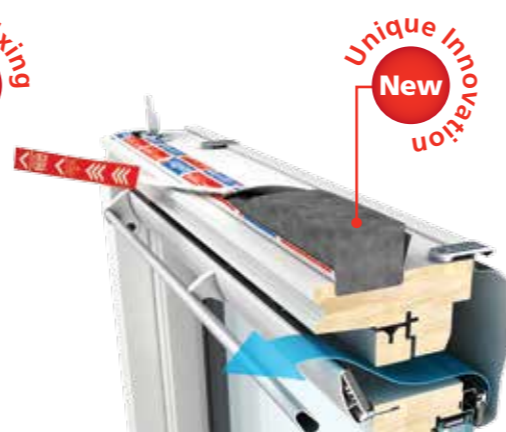

**Expanding Thermal Collar**

Unlike other roof windows, our Thermal Collar is integrated into the window frame. The collar is activated by simply pulling release tabs for a fast insulation solution, combating cold bridging.

- ▶ No additional components to buy.
- ▶ No secondary fixing required.

**Futuretherm Technology™**

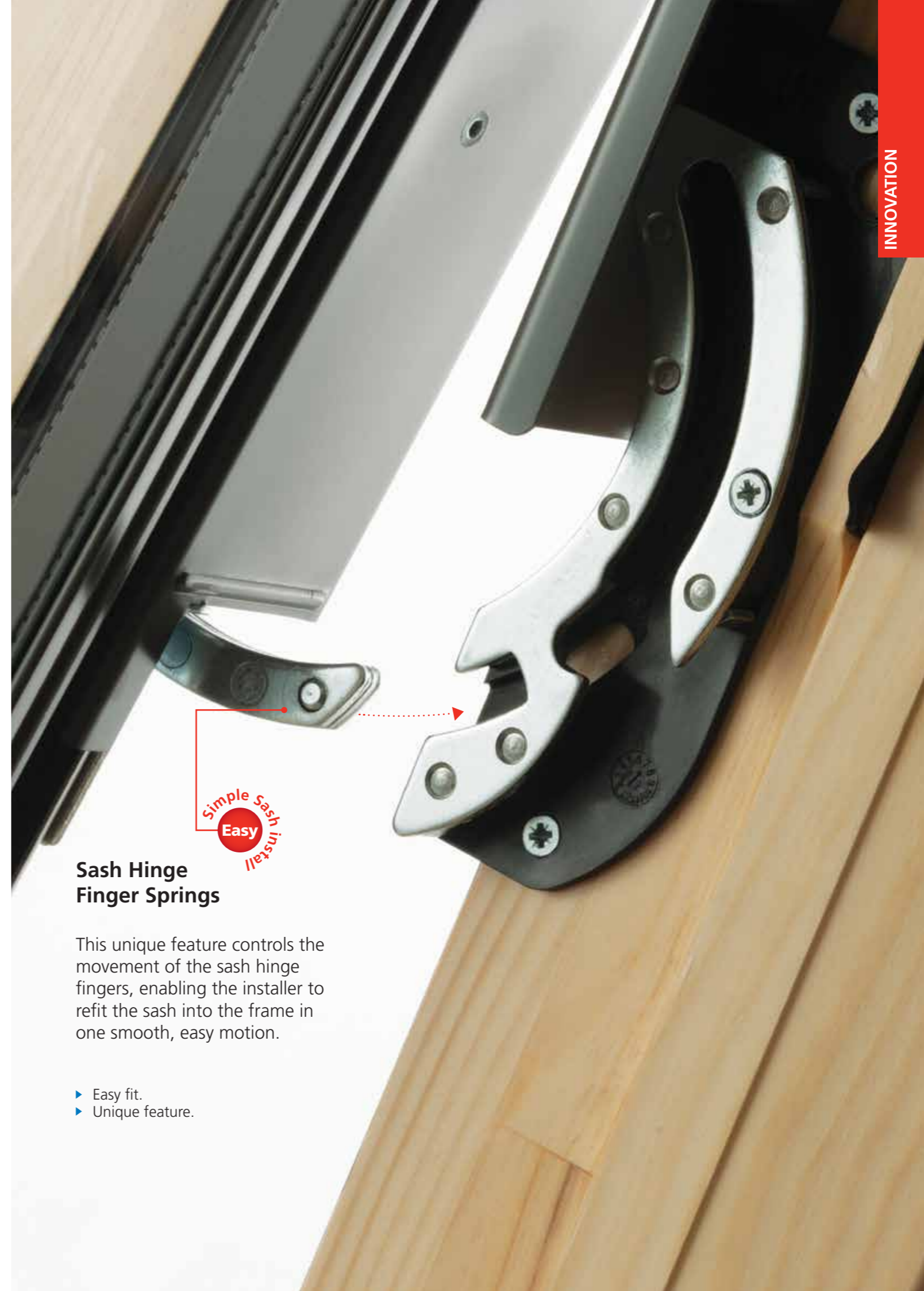

**Sash Hinge Finger Springs**

This unique feature controls the movement of the sash hinge fingers, enabling the installer to refit the sash into the frame in one smooth, easy motion.

- ▶ Easy fit.
- ▶ Unique feature.

 **Lower**

## Streamlined Fit for enhanced performance.

### Streamlined Fit as Standard

Every Keylite **Futuretherm** window is recessed as standard, sitting lower in the roof than before.

The recessed fit enhances the overall appearance of the roof and improves the thermal performance of the window.

The recessed fit is achieved with Keylite's standard flashing range so there are no additional costs required.

- ▶ No additional cost.
- ▶ Improved thermal performance.

### Low Profile Hood

The new hood has a lower profile and features a more sculptured design, enhancing its profile in the roof.

- ▶ New design.
- ▶ Lower profile.

**Futuretherm**  
Technology™





 **Warmer**

The **Futuretherm** innovations combine to make Keylite warmer, with enhanced U-values.

**Expanding Thermal Collar**

The unique Expanding Thermal Collar fills the gap between the window frame and the roof. No other window has this feature pre-fitted as standard.

The insulation provided reduces heat loss and cold bridging, preventing condensation occurring around the window.

- ▶ Warmer installations.
- ▶ Eliminates cold bridging.

**Warm Edge Glazing**

Every **Futuretherm** window now has a Warm Edge Glazing unit as standard, to enhance the window's performance and reduce the occurrence of condensation.

- ▶ Superior glazing unit as standard.
- ▶ Reduction in condensation.

**U**  
VALUE  
**1.3**  
W/m<sup>2</sup>k

**Expanding Thermal Collar**



**Expanding Thermal Collar**  
Finishes flush with the roofing battens, resulting in reduced cold bridging, for a warmer roof junction detail.



# Natural Light For Every Room

While daylight levels may vary through the seasons, its direction always follows the same path, making it possible for you to optimise the positioning of your roof windows.

## North Facing

These windows face away from direct sunlight. Capture more daylight by choosing larger roof windows.

## South Facing

This is the optimum position to flood direct sunlight into your room.

## East Facing

The sun rises in the East providing direct sunlight in the morning.

## West Facing

The sun sets in the West at the end of the day for evening sunlight.

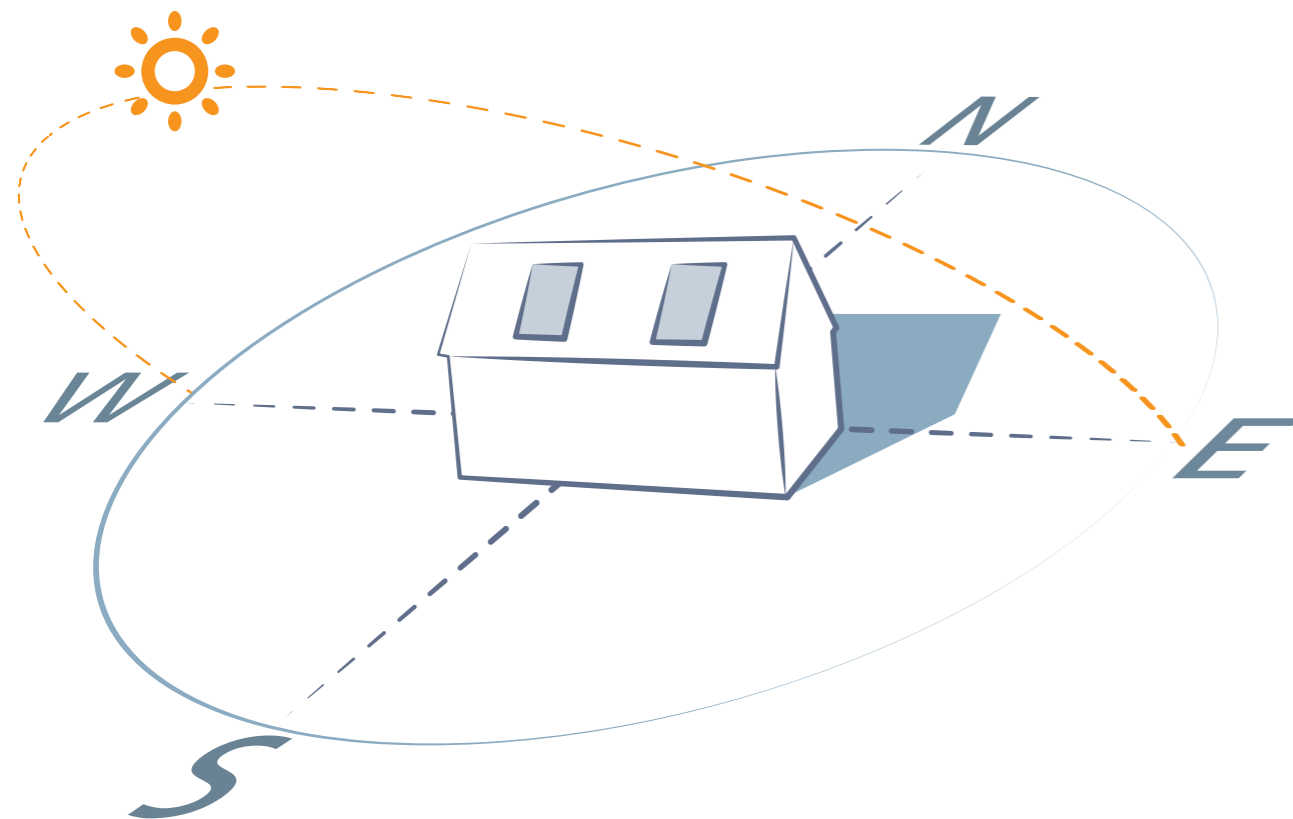

## Options for every roof type



### Sloping Ceilings

Keylite can provide optimum daylight and ventilation in loft conversions and new build rooms with sloping ceilings. The amount of light streaming in to the room below will be determined by your product choice.

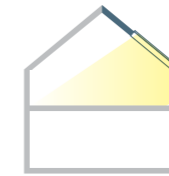

### Vertical Combinations

An impressive floor to ceiling effect can be achieved by combining vertical glazing with roof windows in a Keylite Vertical Bi-Lite.

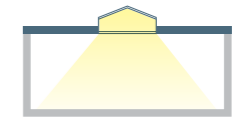

### Atrium Style

The most stylish solution for flat roofs. Ideal in kitchen and living areas which will be enhanced by both the quality of the light and the aesthetic appeal of the atrium.



### Vaulted Ceilings

Rooms with vaulted ceilings are dramatically enhanced by the addition of overhead roof windows. The amount of light can be controlled by the size, quantity and position of your windows.

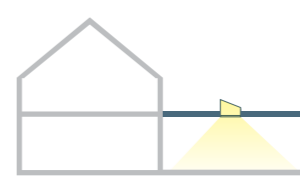

### Flat Roofs

An extension need never be dark again because Keylite has a range of overhead configurations designed to suit flat roof extensions.

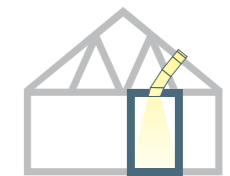

### Enclosed Spaces

Even enclosed spaces can enjoy natural light by using a Keylite Sun Lite™ to transfer light from the roof to the room below, when conventional roof windows cannot be used.



To use this selector, please choose an option at each step.



# Product Selector

STEP  
**1**  
Window Style & Size

**Centre Pivot**

The most popular and versatile choice, suitable for most applications.



**Fire Escape/ Top Hung**

Choose when a means of escape is required or when a 45° opening is preferred.



**Conservation Window**

Ideal for use in a period style property, replicating the look of a traditional sky light.



**Vertical Bi-Lite**

Maximise the light and ventilation in your room by combining both a pitched and vertical window.



**Flat Roof Apex**

These elegant overhead features provide natural daylight for spaces under flat roofs. Ideal for kitchens and living areas.



**Flat Roof System**

Available in single or combi formats to enable the fitting of any Keylite Roof Window onto a flat roof.

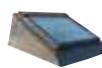

**Ridge Windows**

Windows installed at the highest point of a pitched ceiling create a striking feature.



STEP  
**2**  
Glazing Options

**Thermal Glazing**

Our standard glazing - incorporates warm edge technology.



- ▶ Toughened outer pane.
- ▶ A centre pane U value of 1.0 w/m<sup>2</sup>k.

**Hi-Therm Glazing**

Upgrade to Hi-Therm for additional safety and user features.



- ▶ Toughened outer pane and Laminated inner pane for safety.
- ▶ Self-Cleaning glass.
- ▶ A centre pane U value of 1.0 w/m<sup>2</sup>k.

**Triple Glazing**

The top performing triple glazed option provides maximum comfort.



- ▶ Toughened outer pane.
- ▶ Self-cleaning glass for convenience.
- ▶ Krypton Gas filled cavity for a centre pane U value of 0.6 w/m<sup>2</sup>k.
- ▶ Enhanced sound and thermal insulation.

**Keylite Secure**

Enhanced levels of safety and security.

- ▶ P4A class glazing certified to class 2 burglary resistance under EN 1627.
- ▶ A bottom handle provides additional locking.
- ▶ Only available on Centre Pivot Windows.

STEP  
**3**  
Window Finish

**Natural Pine Finish**

Our standard Pine Finish enhances the natural beauty of the wood, with a hard wearing, clear, satin lacquer applied in multiple coats. Pine Finish is a practical choice for most interiors.



**White Finish**

Upgrade to White Finish for a contemporary style which looks great in every room. The wipe clean, polyurethane paint coating has moisture resistant qualities, making it ideal for use in kitchens or bathrooms.



STEP  
**4**  
Opening Method

**Manual**

Our standard windows feature an efficient manual opening and ventilation control. The top handle on our Centre Pivot window is comfortable in use, while the bottom handle on our Escape/Top Hung windows enables the user to utilise the full 45° opening range.



**Electric**

The electric window option provides finger-tip control, ideal for windows in high or inaccessible positions.



Options exist to combine electric opening with electric operation of blinds, to give maximum control over ventilation and shade. This can be invaluable in overhead applications.

- ▶ Fingertip control.
- ▶ Options for ventilation and shade.
- ▶ Rain sensor for auto closing.

STEP  
**5**  
Blinds

**Integral Blind**

The amazing integral blind is available in most window configurations. This provides an easy care solution where the blind is contained within the glazing unit, completely protecting it from damage or dust. Available in Thermal Glazing only.



**Genuine Keylite Blinds**

Genuine Keylite blinds are specially designed for a perfect fit and are guaranteed for 3 years.



The blind's rail system also enables the blind to deliver thermal benefits with up to 20% reduction in heat loss.

- ▶ **Blackout Blinds** provide a 100% blackout, perfect for bedrooms or any other area where you wish to achieve darkness.
- ▶ **Dimout Blinds** provide finger-tip control of both privacy and shade for any room.

Now available with **Electric Operation**

STEP  
**6**  
Installation Accessories

**Flashings & Accessories**

Keylite windows require the use of original Keylite flashings and accessories on every Keylite window installation.



- ▶ Flashing Kits.
- ▶ Vapour Collar.
- ▶ Underfelt Collar.
- ▶ Security Lock.
- ▶ Opening Restrictor.
- ▶ Opening Pole.

CHOICE

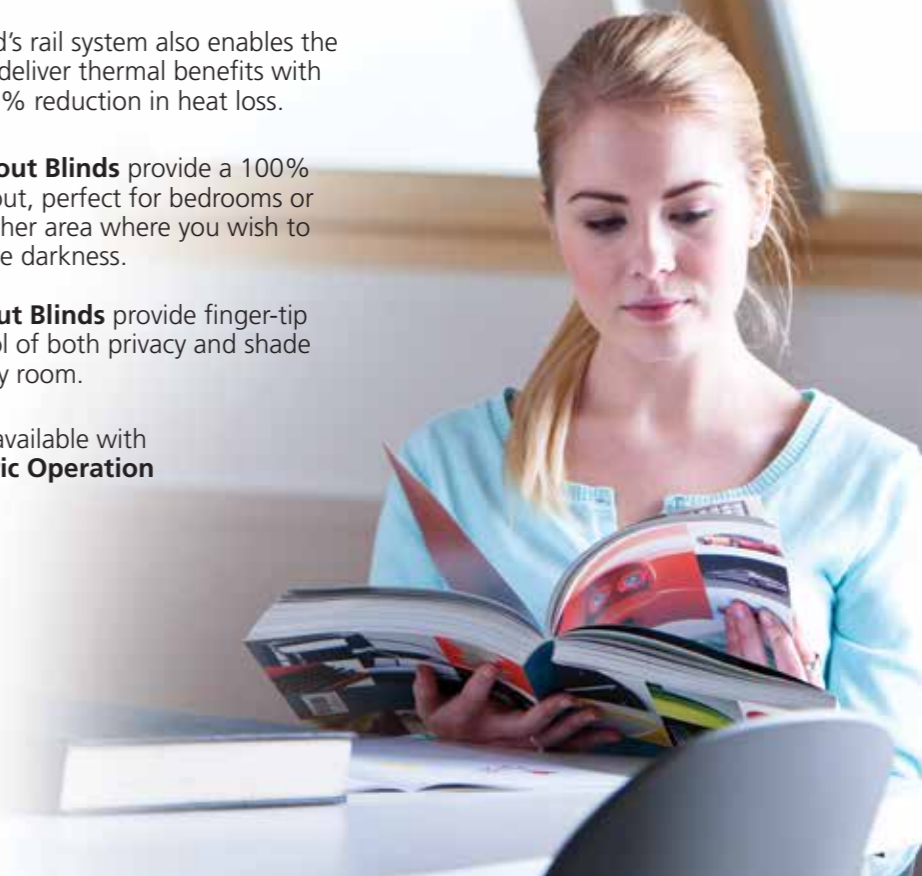

22>23

# A Brighter Day

Go bigger to bring **more sky** inside and make every day brighter.

Choose larger windows, or install multiple windows, to create a completely different feel in any room. Keylite has a wide range of options, allowing you to maximise both light and ventilation.

- ▶ Multi-window options for every project.
- ▶ Vertical Bi-Lites for floor to ceiling views.

For further information on Multi-window options and Vertical Bi-Lites see **Pages 40-43**.



# Power up Electric

Centre Pivot windows installed in **out of reach** locations can be opened with ease by selecting the electric option.

With fingertip control of ventilation and shade, as well as a rain sensor for automatic closing in the event of rain, the electric option is recommended for all installations over 2.5m high.

**Options For:**

- ▶ Wall mounted control
- ▶ Thermostatic control
- ▶ Timer control
- ▶ CO<sup>2</sup> venting
- ▶ Electric blinds
- ▶ Multiple window control for commercial applications
- ▶ **Retro-Fit an electric kit to your existing roof window**

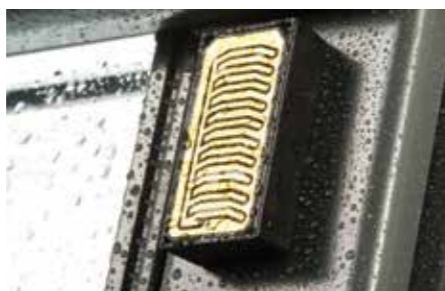

▶ Rain Sensor for auto closing.

Available for Centre Pivot Roof Windows	Product Code
<b>Premium Electric Window</b> Includes motor, remote control, plug-in transformer and rain sensor.	PEK
<b>Standard Electric Window</b> Includes motor and hard wired transformer switch.	SEK

**How to Order**

**New Windows**  
Please specify "Electric" when ordering new windows for a factory fitted solution. Specify SEK Kit or PEK Kit.

**Existing Windows**  
Please order a kit for retro fitting to existing windows. Specify SEK Kit or PEK Kit.

**Technical Support**

**Installation**  
Please visit [www.keyliterateofwindows.com](http://www.keyliterateofwindows.com) to view installation details.

**Multiple Window Operations**  
Please contact the Keylite Technical Team for commercial projects and multiple window operations.



CHOICE

## Premium Electric Window

- ▶ Pre-fitted to window.
- ▶ Simply plug it in! No need for complex wiring.
- ▶ Multi window function options.
- ▶ Available with Automatic Blinds.

# Energy Efficient Glazing

Choose a **high performance glazing** option to maximise energy efficiency.

Keylite Roof Windows can be supplied with a wide range of glazing variants including thermal properties, tinted, frosted and self-cleaning glass.

## Standard Glazing

### THERMAL

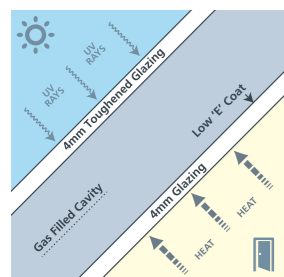

- ▶ 4mm toughened on outer pane.
- ▶ 20mm Argon gas filled cavity.
- ▶ 4mm float inner pane.
- ▶ Warm edge glazing unit.

**U VALUE**  
**1.0**  
W/m²k

## Optional Glazing Upgrades

### HI THERM

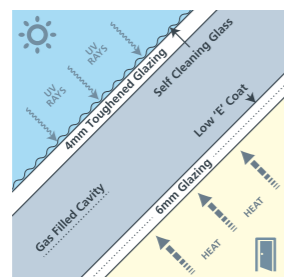

- ▶ Self-cleaning glass on outer pane.
- ▶ 4mm toughened outer pane.
- ▶ 18mm Argon gas filled cavity.
- ▶ 6mm laminated inner pane.
- ▶ Ideal safety glazing for windows below 800mm from finish floor level or windows above head height.
- ▶ Improves sound reduction, safety and a reduction in the harmful effects of UV light.
- ▶ Warm edge glazing unit.

**U VALUE**  
**1.0**  
W/m²k

### TRIPLE

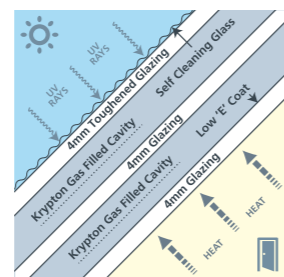

- ▶ Self-cleaning glass on outer pane.
- ▶ 4mm toughened outer pane.
- ▶ 10mm Krypton gas filled cavity.
- ▶ 4mm float centre pane.
- ▶ 8mm Krypton gas filled cavity.
- ▶ 4mm float inner pane.
- ▶ Triple glazing offers a lower U value.
- ▶ Warm edge glazing unit.

**U VALUE**  
**0.6**  
W/m²k

### BRONZE

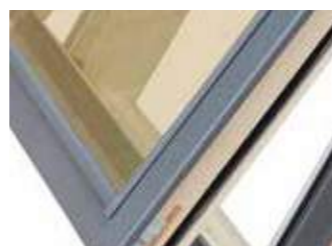

### FROSTED



### SELF CLEANING



NOTE: Triple Glazing is not available with Integral Blind, Hi Therm Glazing is not available with Integral Blind. In case of Integral Blind Window, the Low 'E' Coating is on the inner surface of the outside pane. This has no detrimental effect on 'U' value. U value is based on a centre pane measurement.

# Clever Integral Blind

The roof window with a **blind sealed inside the glass** for protection against moisture, dust and damage.

- ▶ Factory-fitted blind, sealed inside the energy efficient double glazing unit.
- ▶ Requires no cleaning - ideal for sterile and/or hygienic environments eg. hospitals or surgeries.
- ▶ Provides enhanced sun-shading and improves the U-value of the sealed unit.
- ▶ Available in manual or electric options.

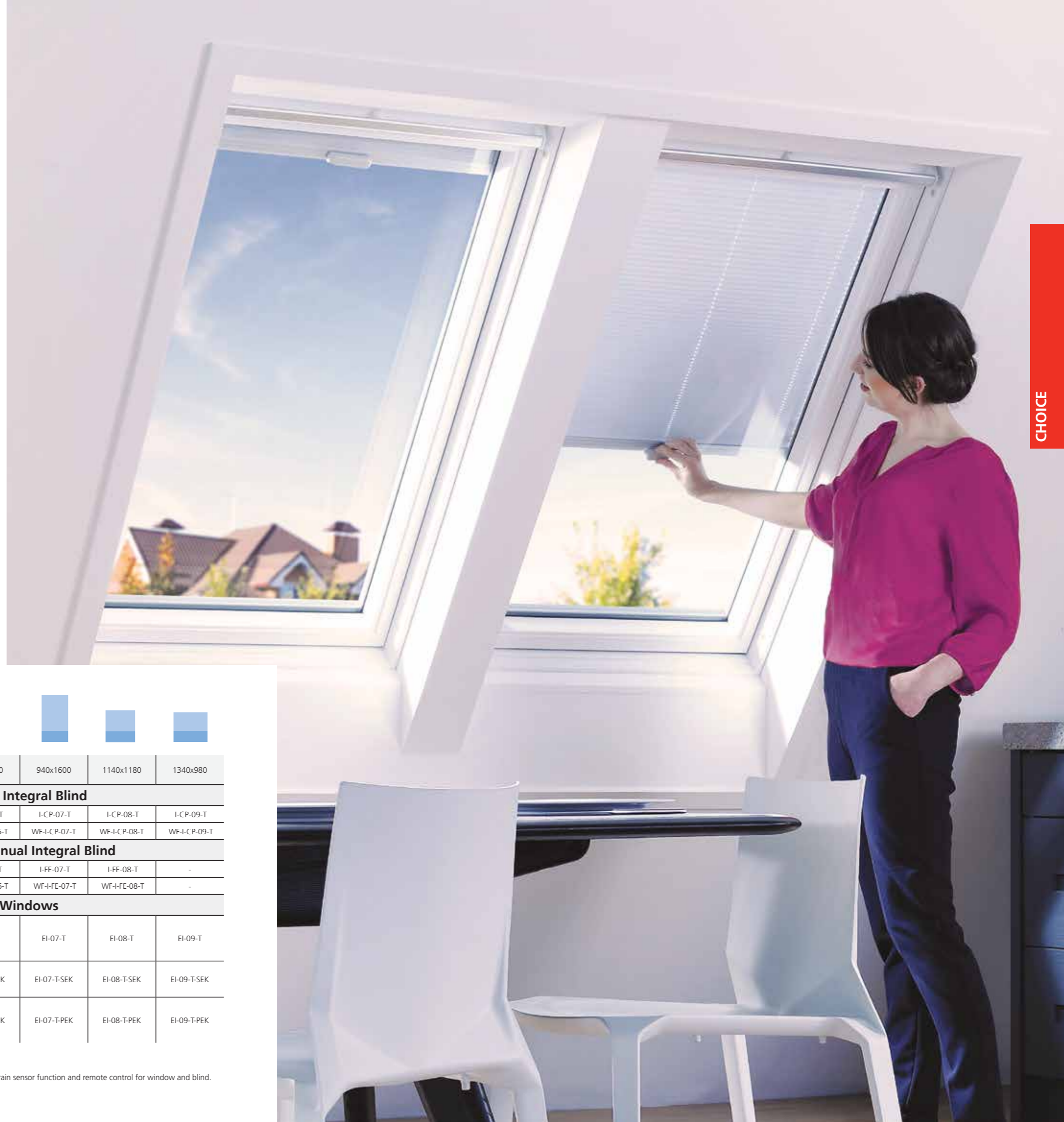

CHOICE



(nominal) WxH mm	550x780	550x980	660x1180	780x980	780x1180	780x1400	940x1600	1140x1180	1340x980
<b>Centre Pivot Roof Window with Manual Integral Blind</b>									
<b>PINE FINISH</b>	I-CP-01-T	I-CP-02-T	I-CP-03-T	I-CP-04-T	I-CP-05-T	I-CP-06-T	I-CP-07-T	I-CP-08-T	I-CP-09-T
<b>WHITE FINISH</b>	WF-I-CP-01-T	WF-I-CP-02-T	WF-I-CP-03-T	WF-I-CP-04-T	WF-I-CP-05-T	WF-I-CP-06-T	WF-I-CP-07-T	WF-I-CP-08-T	WF-I-CP-09-T
<b>Top Hung/Fire Escape Roof Window with Manual Integral Blind</b>									
<b>PINE FINISH</b>	-	I-TH-02-T	I-FE-03-T	I-FE-04-T	I-FE-05-T	I-FE-06-T	I-FE-07-T	I-FE-08-T	-
<b>WHITE FINISH</b>	-	WF-I-TH-02-T	WF-I-FE-03-T	WF-I-FE-04-T	WF-I-FE-05-T	WF-I-FE-06-T	WF-I-FE-07-T	WF-I-FE-08-T	-
<b>Electric Upgrades for Integral Blind Windows</b>									
* <b>Manual Window, Electric Blind, Centre Pivot &amp; Top Hung</b>	EI-01-T	EI-02-T	EI-03-T	EI-04-T	EI-05-T	EI-06-T	EI-07-T	EI-08-T	EI-09-T
** <b>Std Elec Window, Electric Blind, Centre Pivot Only</b>	EI-01-T-SEK	EI-02-T-SEK	EI-03-T-SEK	EI-04-T-SEK	EI-05-T-SEK	EI-06-T-SEK	EI-07-T-SEK	EI-08-T-SEK	EI-09-T-SEK
*** <b>Prem Elec Window, Electric Blind, Centre Pivot Only</b>	EI-01-T-PEK	EI-02-T-PEK	EI-03-T-PEK	EI-04-T-PEK	EI-05-T-PEK	EI-06-T-PEK	EI-07-T-PEK	EI-08-T-PEK	EI-09-T-PEK

\*EI blind operates via hard wired switch \*\*SEK kit operates both window and blind via a wall mounted switch. \*\*\*PEK is supplied with rain sensor function and remote control for window and blind.

30>31

# Colour with **Blinds**

Choose from the extensive range of genuine Keylite blinds for **control of light** and privacy, co-ordinating perfectly with your home.

- ▶ Easy to install and use.
- ▶ Options for Blackout or Dimout.

See **Page 54** for more details.





# Make it White

Choose white for a **fresh modern** look to your interiors.

The wipe clean polyurethane paint coating has **moisture resistant** qualities, making white finish windows ideal for use in kitchens, bathrooms and other humid spaces.

- ▶ Ideal for bathrooms & kitchens.
- ▶ Complements contemporary interiors.
- ▶ Low maintenance.
- ▶ Available on all Keylite Roof Windows.

## White Finish Roof Windows



Window Sizes (WxH)	550x780	550x980	550x1180	660x1180	780x980	780x1180	780x1400	940x1400	940x1600	1140x1180	1340x980	1340x1400
	<b>Centre Pivot</b>											
Thermal Product Code	WF-CP-01-T	WF-CP-02-T	WF-CP-01C-T	WF-CP-03-T	WF-CP-04-T	WF-CP-05-T	WF-CP-06-T	WF-CP-07F-T	WF-CP-07-T	WF-CP-08-T	WF-CP-09-T	WF-CP-10-T
Hi Therm Product Code	WF-CP-01-HT	WF-CP-02-HT	WF-CP-01C-HT	WF-CP-03-HT	WF-CP-04-HT	WF-CP-05-HT	WF-CP-06-HT	WF-CP-07F-HT	WF-CP-07-HT	WF-CP-08-HT	WF-CP-09-HT	WF-CP-10-HT
Triple Glazed Product Code	WF-CP-01-KTG	WF-CP-02-KTG	WF-CP-01C-KTG	WF-CP-03-KTG	WF-CP-04-KTG	WF-CP-05-KTG	WF-CP-06-KTG	WF-CP-07F-KTG	WF-CP-07-KTG	WF-CP-08-KTG	WF-CP-09-KTG	-
	<b>Top Hung</b>			<b>Fire Escape</b>								
Thermal Product Code	-	WF-TH-02-T	-	WF-FE-03-T	WF-FE-04-T	WF-FE-05-T	WF-FE-06-T	-	WF-FE-07-T	WF-FE-08-T	-	-
Hi Therm Product Code	-	WF-TH-02-HT	-	WF-FE-03-HT	WF-FE-04-HT	WF-FE-05-HT	WF-FE-06-HT	-	WF-TH-07-HT	WF-FE-08-HT	-	-

## White Finish Conservation Roof Windows



Window Sizes (WxH)	550x780	550x980	660x1180	780x1180	780x1400	1340x980	550x980	660x1180	780x1180	780x1400
	<b>Centre Pivot</b>						<b>Top Hung</b>		<b>Fire Escape</b>	
Thermal Product Code	CW-WF-CP-01-T	CW-WF-CP-02-T	CW-WF-CP-03-T	CW-WF-CP-05-T	CW-WF-CP-06-T	CW-WF-CP-09-T	CW-WF-TH-02-T	CW-WF-FE-03-T	CW-WF-FE-05-T	CW-WF-FE-06-T
Hi Therm Product Code	-	CW-WF-CP-02-HT	CW-WF-CP-03-HT	CW-WF-CP-05-HT	CW-WF-CP-06-HT	CW-WF-CP-09-HT	CW-WF-TH-02-HT	CW-WF-FE-03-HT	CW-WF-FE-05-HT	CW-WF-FE-06-HT



CHOICE

# Centre Pivot Roof Windows (CP)

Our most versatile window, suitable for single or multiple applications in any roof with a pitch of 15°-90°.

The opening handle is conveniently placed at the top of the window and also controls ventilation, giving the option of fresh air flow even when the window is locked and secure.

## Features



### ▲ Easy Cleaning

The window rotates through 180° and locks in place, allowing easy access to the outer surface of the glass which can be cleaned from inside the room.

### ▲ Effective Ventilation

An initial short pull downwards on the handle opens the ventilation flap while the window is still securely closed; a further gentle pull opens the window.

### ▶ Thermal Performance

Only Keylite windows have an Expanding Thermal Collar, Warm Edge Glazing and a Streamlined Fit as standard, leading to enhanced thermal performance.

### ▶ Versatility

Please refer to our full range of upgrades and options that increase the versatility of the Centre Pivot range.

### Keylite Secure

Our new Secure Roof Window offers enhanced levels of safety and security. Features P4A class glazing certified to class 2 burglary resistance under EN 1627. A bottom handle provides additional locking.

### ▶ Easy Maintenance

Due to the quality of the lacquered finish and an innovative maintenance free hinge, Keylite windows are extremely easy to maintain.



## Optional Upgrades

### White Finish

A fresh and contemporary look.

Page 32



### Electric Operation

Fingertip control for out of reach windows.

Page 24



### Integral Blind

The clever built-in shading solution.

Page 28



### Glazing Options

Add extra thermal performance.

Page 26



### Surface Fitted Blind

Choose easy fitting Genuine Keylite blinds.

Page 54



## Accessories

Opening Poles, Security locks and Restrictors.

Page 61

## Installation Kits

Flashings and Enhanced Installation.

Pages 58-60



RANGE



Window Sizes (WxH)	550x780	550x980	550x1180	660x1180	780x980	780x1180	780x1400	940x1400	940x1600	1140x1180	1340x980	1340x1400
	<b>Pine Finish</b>											
Thermal Product Code	CP-01-T	CP-02-T	CP-01C-T	CP-03-T	CP-04-T	CP-05-T	CP-06-T	CP-07F-T	CP-07-T	CP-08-T	CP-09-T	CP-10-T
Hi Therm Product Code	CP-01-HT	CP-02-HT	CP-01C-HT	CP-03-HT	CP-04-HT	CP-05-HT	CP-06-HT	CP-07F-HT	CP-07-HT	CP-08-HT	CP-09-HT	CP-10-HT
Triple Glazed Product Code	CP-01-KTG	CP-02-KTG	CP-01C-KTG	CP-03-KTG	CP-04-KTG	CP-05-KTG	CP-06-KTG	CP-07F-KTG	CP-07-KTG	CP-08-KTG	CP-09-KTG	-
<b>NEW</b> Keylite Secure Product Code	CP-01-KS	CP-02-KS	CP-01C-KS	CP-03-KS	CP-04-KS	CP-05-KS	CP-06-KS	CP-07F-KS	CP-07-KS	CP-08-KS	CP-09-KS	CP-10-KS
	<b>White Finish</b>											

Note: To order White Finish please add the prefix "WF" to the code ie. WF-CP-04-T - See Page 32 for more info.

# Fire Escape/Top Hung Roof Windows (FE/TH)

The Keylite Fire Escape Roof Window opens to 45°, complying with statutory regulations.

This is ideal in low pitch roofs as the window opens outward, maximising the daylight that enters the room without the sash encroaching on your valuable internal space.

## Features

### Means of Escape

As a means of escape, the window opens to an unobstructed area for safe exit, in the event of an emergency. The opening handle located at the bottom of the window is easily accessible.

### Effective Ventilation

Effective ventilation is provided by the vent flap at the top of the window which regulates the air flow, even when the window is closed.

### Easy to Use\*

The multi-stop opening feature allows the user to simply push the window to any position between 0° and 45° and remain open for maximum flexibility.

### Thermal Performance

Only Keylite windows have an Expanding Thermal Collar, Warm Edge Glazing and a Streamlined Fit as standard, leading to enhanced thermal performance.

\*Multi-stop feature available in standard roof window sizes only.

The window should have an unobstructed openable area that is at least 0.33m<sup>2</sup> and at least 450mm high and 450mm wide.\*\*

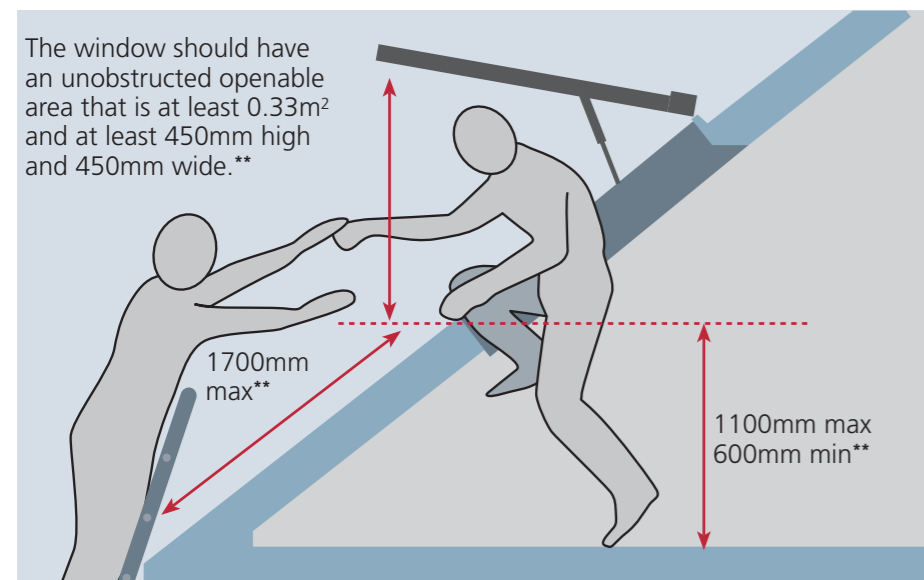

**Important:**  
\*\*Check with your local Building Control Department with regards to the position of the window.

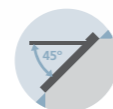

## Optional Upgrades

### White Finish

A fresh and contemporary look.  
Page 32



### Glazing Options

Add extra thermal performance.  
Page 26



### Integral Blind

The clever built-in shading solution.  
Page 28



### Surface Fitted Blind

Choose easy fitting Genuine Keylite blinds.  
Page 54



RANGE



Window Type	Top Hung	Fire Escape									
Window Sizes (WxH)	550x980	550x1180	660x1180	780x980	780x1180	780x1400	940x1400	940x1600	1140x1180	1340x980	1340x1400
		Pine Finish									
Thermal Product Code	TH-02-T	FE-01C-T	FE-03-T	FE-04-T	FE-05-T	FE-06-T	FE-07F-T	FE-07-T	FE-08-T	FE-09-T	FE-10-T
Hi Therm Product Code	TH-02-HT	FE-01C-HT	FE-03-HT	FE-04-HT	FE-05-HT	FE-06-HT	FE-07F-HT	FE-07-HT	FE-08-HT	FE-09-HT	FE-10-HT
		White Finish									

Note: To order White Finish please add the prefix "WF" to the code ie. WF-FE-04-T - See Page 32 for more info.

Note: No electric option

# Conservation Roof Windows (CW)

The Keylite Conservation Roof Window is designed to complement both renovation and new build projects in a traditional style.

The black central glazing bar and low profile external flashing maintain the traditional character of the building, whilst still accommodating the flow of natural light to the interior below.

## Features



▲ **Classic Design**  
While traditional in its external appearance, the standard Conservation Roof Window benefits from all of the advanced Keylite features including thermal efficiency, low maintenance and ventilation control.



▲ **Centre Pivot**  
Centre Pivot Conservation Roof Windows available in Pine or White Finish.



◀ **Top Hung**  
Top Hung/Fire Escape Conservation Roof Windows available in Pine or White Finish.

◀ **Thermal Performance**  
Only Keylite windows have an Expanding Thermal Collar, Warm Edge Glazing and a Streamlined Fit as standard, leading to enhanced thermal performance.

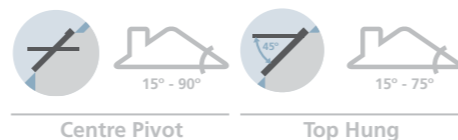

## Optional Upgrades

**White Finish**  
A fresh and contemporary look.  
Page 32



**Electric Operation**  
Fingertip control for out of reach windows.  
Page 24



**Integral Blind**  
The clever built-in shading solution.  
Page 28



**Surface Fitted Blind**  
Choose easy fitting Genuine Keylite blinds.  
Page 54



## Accessories

Opening Poles, Security locks and Restrictors.  
Page 61

## Installation Kits

Flashings and Enhanced Installation.  
Pages 58-60



RANGE



Window Sizes (WxH)	550x780	550x980	660x1180	780x1180	780x1400	1340x980	550x980	660x1180	780x1180	780x1400
<b>Pine Finish</b>										
	<b>Centre Pivot</b>						<b>Top Hung</b>		<b>Fire Escape</b>	
<b>Thermal Product Code</b>	CW-CP-01-T	CW-CP-02-T	CW-CP-03-T	CW-CP-05-T	CW-CP-06-T	CW-CP-09-T	CW-TH-02-T	CW-FE-03-T	CW-FE-05-T	CW-FE-06-T
<b>Hi Therm Product Code</b>	-	CW-CP-02-HT	CW-CP-03-HT	CW-CP-05-HT	CW-CP-06-HT	CW-CP-09-HT	CW-TH-02-HT	CW-FE-03-HT	CW-FE-05-HT	CW-FE-06-HT
<b>White Finish</b>										

Note: To order White Finish please insert the reference "WF" to the code ie. CW-WF-CP-04-T - See Page 32 for more info.

# Combination Window Options

The Keylite Technical Team will assist you to specify the optimum solution for your project and create an order schedule for combination windows and flashings.

## Example specification Combination Roof Windows

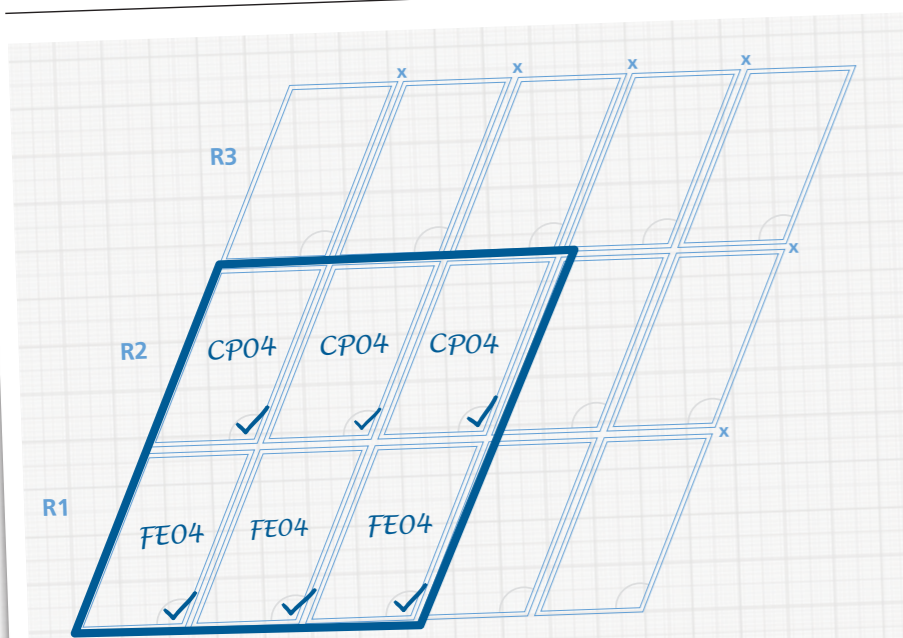

x = Spacing between windows

R1: 3No. FE04T RoofWindows

R2: 3No. CP04T RoofWindows - Electric opening!

R3: —

Window finish: *White*

Spacing (x):

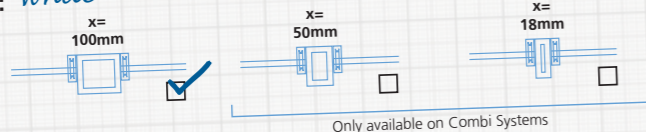

Roof finish: *Tile roof*

Internal support trim: *White*

Blinds	
Surface: <input checked="" type="checkbox"/> Integral	<input type="checkbox"/> Electric
Surface: <input type="checkbox"/> Integral	<input type="checkbox"/> Electric <input checked="" type="checkbox"/>
Surface: <input type="checkbox"/> Integral	<input type="checkbox"/> Electric <input type="checkbox"/>

## Specifying a combination layout:

### STEP 1

Choose your windows:

- ▶ Style
- ▶ Size
- ▶ Electric or manual opening
- ▶ Surface, Integral or Electric blinds



### STEP 2

Choose your window layout.



#### Combi System

Side by side on a horizontal plane



#### Bi-Lite System

One over the other on a vertical plane

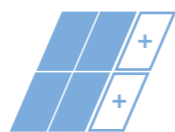

#### Grid System

Multiple windows in grid formation

### STEP 3

Spacing between the windows.

- ▶ 100mm
- ▶ 50mm (on Combi System only)
- ▶ 18mm (on Combi System only)

### STEP 4

Type of flashing required to suit your roof finish.

- ▶ Tile Roof
- ▶ Slate Roof
- ▶ Plain Tile Roof - Combi System only

### STEP 5

Choose White or Pine Internal Support Trimmers.



# Vertical Bi-Lite Window System (VBL)

The Vertical Bi-Lite is a vertical window component, which combines with a Keylite Roof Window to produce an attractive glazing feature. This is a highly effective way to maximise the levels of light and ventilation in any room.

## How to order your Vertical Bi-Lite

Follow these steps when choosing a vertical window to combine with your roof window.

### STEP 1

Decide if the system you require is a single, double or triple.



### STEP 2

Select your roof window(s) in size 04, 05, 06. Choose from:

- ▶ Integral Windows **Page 28**
- ▶ Centre Pivot **Page 34**
- ▶ White Finish **Page 32**
- ▶ Top Hung **Page 36**

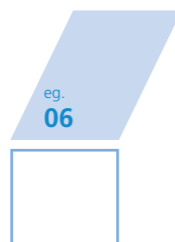

### STEP 3

Specify if your vertical window is:

- 600mm deep**  
(Tilt only available) or
- 950mm deep**  
(Tilt only or Tilt & Turn available)

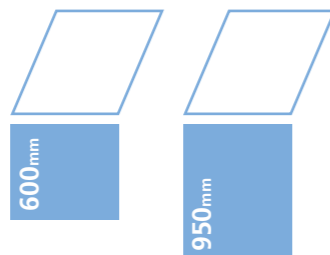

Note: 950mm Tilt & Turn can qualify as a means of escape in certain sizes, please contact the Keylite Technical Team for more information.

### STEP 4

Flashing is included with the price of your vertical window so please specify your roof finish (slate or tile) and roof pitch.

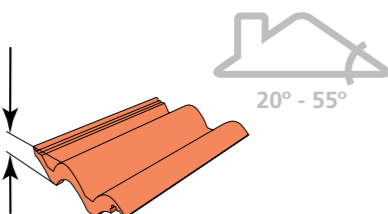

## Optional Upgrades

### White Finish

A fresh and contemporary look.  
**Page 32**



### Integral Blind

The clever built-in shading solution.  
**Page 28**



### Surface Fitted Blind

Choose easy fitting genuine Keylite blinds.  
**Page 54**



### Tilt & Turn

Tilt & Turn opening is optional on 950mm windows.



## Installation Kits

Flashings and Enhanced Installation.  
**Page 59-60**



RANGE

## Vertical Bi-Lite Sizes and Dimensions

	Single	Double	Triple
<b>Length of Roof Window(s) (mm)</b>	980, 1180, 1400		
<b>Height of Vertical Window(s) (mm)</b>	600, 950		
<b>Width of Vertical Bi-Lites (mm)</b>			
Single	780		
Double	780		
Triple	780		
<b>Pitch</b>	Min 20°, Max 55°		

Tilt + Turn is only available on 780mm wide, 950mm high vertical windows (single, double & triple)

For VBL Systems outside the above please contact Keylite Sales Team

	H W	H W	H W
	Single	Double	Triple
<b>(nominal) WxH mm</b>	780mm Wide	1570mm Wide	2370mm Wide
<b>PINE FINISH</b>			
<b>H = 600mm tilt only</b>	VBL-780X600-T	DVBL-780X600-T	TVBL-780X600-T
<b>H = 950mm tilt only</b>	VBL-780X950-T	DVBL-780X950-T	TVBL-780X950-T
<b>H = 950mm tilt+turn</b>	VBL-780X950-TT	DVBL-780X950-TT	TVBL-780X950-TT
<b>WHITE FINISH</b>			

To order White Finish please insert the reference "WF" to the code ie. WF-VBL-780X950-TT

# Ridge Window Roof Windows (RG)

Keylite Ridge Roof Windows may be installed along the roof ridge to maximise light and space at the highest point of the pitched ceiling.

## Features

- ▶ Keylite Ridge Roof Windows are ideal for both **domestic** and **commercial applications**, and are available for the following ranges: Centre Pivot, Conservation and White Finish Roof Windows, all with the option of an Integral Blind.
- ▶ Usually installed in **out of reach** locations, these roof windows may be electrically operated by hand-held remote control or a wall-mounted switch.
- ▶ The installation of Keylite Ridge Roof Windows is very similar to standard roof window installation.
- ▶ The roof windows must be positioned in a way to avoid the sashes colliding when opened.
- ▶ Ridge Windows that are positioned 280mm or more below the ridge can be fitted using standard Keylite Flashings. Windows that are positioned less than 280mm will require Keylite Ridge Flashings. Please contact the Keylite Technical Team to determine the position of your windows.

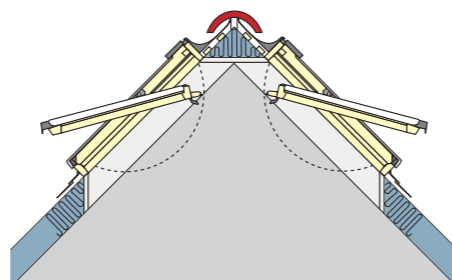

## Optional Upgrades

### White Finish

A fresh and contemporary look.

Page 32



### Electric Operation

Fingertip control for out of reach windows.

Page 24



### Integral Blind

The clever built-in shading solution.

Page 28



### Smoke Vent

Auto opening in the event of a fire.

Page 51



	Single		Double	
Window Sizes (WxH)	780x1180	780x1400	1660x1180	1660x1400
<b>PINE FINISH</b>				
Keylite Thermal Product Code	RG-CP-05-T	RG-CP-06-T	DRG-CP-05-T	DRG-CP-06-T
<b>WHITE FINISH</b>				
Keylite Thermal Product Code	RG-WF-CP-05-T	RG-WF-CP-06-T	DRG-WF-CP-05-T	DRG-WF-CP-06-T

**Please Note:** Windows that are 280mm or more down from the ridge can be fitted using Standard Keylite Flashings. Windows that are less than 280mm will have to be fitted with the Keylite Ridge Flashings. Please specify Tile, Slate or Plain Tile Flashings when placing your order. (Plain Tile = TRF). Also available for Top Hung and Conservation Windows.

# Flat Roof Apex System Roof Windows (FRX)

The Keylite Flat Roof Apex System creates a sophisticated, atrium style roof window, capable of adding function and style to living spaces under flat roofs.

Ideal for kitchens or living areas, the system in single, double or triple formats can totally transform the room with floods of natural light.



▶ The system is supplied complete with the chosen roof windows plus the fully insulated upstand and precision flashings.



## Optional Upgrades

### White Finish

A fresh and contemporary look.

Page 32



### Electric Operation

Fingertip control for out of reach windows.

Page 24



### Integral Blind

The clever built-in shading solution.

Page 28



### Accessories

Choose accessories for extra security and ease of use.

Page 61



	Single			Double			Triple		
Window Sizes (WxH)	780x980	780x1180	780x1400	1570x980	1570x1180	1570x1400	2370x980	2370x1180	2370x1400
Structural Opening Size	760x2115	760x2490	760x2900	1560x2115	1560x2490	1560x2900	2355x2115	2355x2490	2355x2900
<b>PINE FINISH</b>									
Keylite Thermal Product Code	FRX-CP-04-T	FRX-CP-05-T	FRX-CP-06-T	DFRX-CP-04-T	DFRX-CP-05-T	DFRX-CP-06-T	TFRX-CP-04-T	TFRX-CP-05-T	TFRX-CP-06-T
<b>WHITE FINISH</b>									
Keylite Thermal Product Code	To order White Finish please add "WF" to the code ie. FRX-WF-CP-04-T								

For further assistance please contact the Keylite Technical Team

# Flat Roof System Roof Windows (FRS)

Many properties have extensions with flat or near flat roofs. Keylite has developed a Flat Roof System specifically for this application, which allows daylight into the area beneath.

The Keylite Flat Roof System provides all the benefits of natural ventilation and daylight. All roof windows within the entire Keylite range can be integrated within a Flat Roof System.

### The standard system includes:

- ▶ An insulated timber upstand.
- ▶ A Keylite Centre Pivot Thermal Roof Window.
- ▶ FRS Flashings to integrate the window onto the timber upstand.
- ▶ Ideal solution for Warm Roof applications below 15°



### Optional Upgrades

#### White Finish

A fresh and contemporary look.

Page 32



#### Electric Operation

Fingertip control for out of reach windows.

Page 24



#### Smoke Vent

Auto opening in the event of a fire.

Page 51



#### Accessories

Choose accessories for extra security and ease of use.

Page 61



Window Sizes (WxH)	550x780	550x980	660x1180	780x980	780x1180	780x1400	940x1600	1140x1180	1340x980	1340x1400
Structural Opening Size	530x1000	530x1200	640x1400	760x1200	760x1400	760x1620	920x1820	1120x1400	1320x1200	1320x1620
<b>PINE FINISH</b>										
Keylite Therm Product Code	FRS-CP-01-T	FRS-CP-02-T	FRS-CP-03-T	FRS-CP-04-T	FRS-CP-05-T	FRS-CP-06-T	FRS-CP-07-T	FRS-CP-08-T	FRS-CP-09-T	FRS-CP-10-T
<b>WHITE FINISH</b>										
Keylite Thermal Product Code	To order White Finish please add the prefix "WF" to the code ie. FRS-WF-CP-01-T									

Structural opening sizes = Window width -20mm & Window Height +220mm

# Combi Flat Roof System Roof Windows (CFRS)

A practical solution to the installation of pairs of roof windows in a flat roof.

The system is completely pre-fabricated for ease of installation on-site.

### Features

- ▶ Keylite Flat Roof System comes complete with a shaped, insulated wooden kerb and flashing kit.
- ▶ To maximise the amount of natural light entering the room, the front and back framing is angled.
- ▶ The system is also available with Keylite Electric Operation and Smoke Ventilation Systems.



### Optional Upgrades

#### White Finish

A fresh and contemporary look.

Page 32



#### Electric Operation

Fingertip control for out of reach windows.

Page 24



#### Smoke Vent

Auto opening in the event of a fire.

Page 51



Window Sizes (WxH)	1110x780	1110x980	1330x1180	1570x980	1570x1180	1570x1400	1890x1600	2290x1180
Structural Opening Size	1100x1000	1100x1200	1320x1400	1560x1200	1560x1400	1560x1620	1880x1820	2280x1400
<b>PINE FINISH</b>								
Keylite Therm Product Code	CFRS-CP-01-T	CFRS-CP-02-T	CFRS-CP-03-T	CFRS-CP-04-T	CFRS-CP-05-T	CFRS-CP-06-T	CFRS-CP-07-T	CFRS-CP-08-T
<b>WHITE FINISH</b>								
Keylite Therm Product Code	To order White Finish please add "WF" to the code ie. CFRS-WF-CP-01-T							

For further assistance please contact the Keylite Technical Team



## Flat Roof Dome Roof Windows (FRD)

**Keylite Flat Roof Domes are thermoformed with a triple skin construction.**

Polycarbonate is virtually unbreakable, with an impact strength 250 times greater than glass. Keylite Flat Roof Domes can be supplied with a clear or frosted finish.

### Features

- ▶ Triple ply polycarbonate (clear or frosted) and PVCu 150mm splayed upstand.
- ▶ U-Value of 1.3W/m<sup>2</sup>k.
- ▶ Patented security screwbolts.
- ▶ 10 year rooflight / 1 year accessories guarantee.
- ▶ Extended range of ventilation, access, up-stands also available upon request.

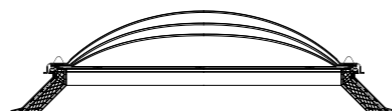

## Flat Roof Access Hatch Roof Windows (FRD-AH)

**The Keylite Flat Roof Access Hatch is designed to allow access to and from roof areas and can form part of a fire escape route.**

The hinged frame opens to 80° to allow a safe route for personnel and equipment, while often avoiding the need to provide other external facilities.

### Features

- ▶ All the standard Flat Roof Dome features are available with the added benefit of a safe access route
- ▶ Telescopic gas or friction struts
- ▶ Available with either internal or external locking mechanisms
- ▶ Excellent insulating value and sound reduction

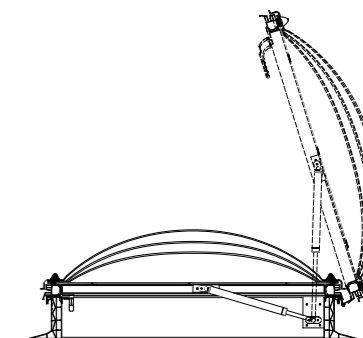

Window Sizes (WxH)	600x600	600x900	800x800	900x900	900x1200	1000x1000	1000x1500	1200x1200
<b>Fixed</b>								
Product Codes	Clear FRD-S6	FRD-R69	FRD-S8	FRD-S9	FRD-R912	FRD-S10	FRD-R1015	FRD-S12
	Frosted FRD-S6-FR	FRD-R69-FR	FRD-S8-FR	FRD-S9-FR	FRD-R912-FR	FRD-S10-FR	FRD-R1015-FR	FRD-S12-FR
<b>Manual Opening</b>								
Product Codes	Clear FRD-S6-M	FRD-R69-M	FRD-S8-M	FRD-S9-M	FRD-R912-M	FRD-S10-M	FRD-R1015-M	FRD-S12-M
	Frosted FRD-S6-FR-M	FRD-R69-FR-M	FRD-S8-FR-M	FRD-S9-FR-M	FRD-R912-FR-M	FRD-S10-FR-M	FRD-R1015-FR-M	FRD-S12-FR-M
<b>Electric Opening</b>								
Product Codes	Clear FRD-S6-E	FRD-R69-E	FRD-S8-E	FRD-S9-E	FRD-R912-E	FRD-S10-E	FRD-R1015-E	FRD-S12-E
	Frosted FRD-S6-FR-E	FRD-R69-FR-E	FRD-S8-FR-E	FRD-S9-FR-E	FRD-R912-FR-E	FRD-S10-FR-E	FRD-R1015-FR-E	FRD-S12-FR-E

Additional sizes are available upon request - for further assistance please contact the Keylite Technical Team.



Window Sizes (WxH)	1000x1000	1000x1200	1500x1200
<b>Access Hatch</b>			
Product Codes	Clear FRD-S10-AH	FRD-R912-AH	FRD-S12-AH
	Frosted FRD-S10-FR-AH	FRD-R912-FR-AH	FRD-S12-FR-AH

Additional sizes are available upon request - for further assistance please contact the Keylite Technical Team.

## Flat Roof Smoke Ventilation Roof Windows (FRD-SVK)

The Keylite Flat Roof Smoke Ventilators are electrically operated smoke vents designed to allow the release of smoke from buildings in the event of a fire.

### Features

- ▶ All Keylite Flat Roof Smoke Ventilators are fully tested and compliant with EN 12101-2 and EN 12101-10.
- ▶ Wide range of sizes available to provide opening vents with Smoke Ventilation areas of 1.0m<sup>2</sup> & 1.5m<sup>2</sup>
- ▶ Opens to 160° within 60 seconds.
- ▶ Accessories include control panels, detectors and manual control points.
- ▶ Actuator can be off set for access purposes as well.
- ▶ 300mm PVC upstand

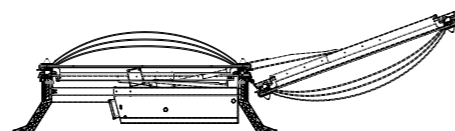

Window Sizes (WxH)	1000x1000	1250x1250	800x1400	1500x1500	1200x1800	
Smoke Ventilation Area (m <sup>2</sup> )	0.88	1.0	1.0	1.5	1.5	
Smoke Ventilation Product Codes	Clear	FRD-S10-SVK	FRD-S125-SVK	FRD-R814-SVK	FRD-S15-SVK	FRD-R1218-SVK
	Frosted	FRD-S10-FR-SVK	FRD-S125-FR-SVK	FRD-R814-FR-SVK	FRD-S15-FR-SVK	FRD-R1218-FR-SVK

Additional sizes are available upon request - for further assistance please contact the Keylite Technical Team.

## Smoke Ventilation Roof Windows (SVK)

The Keylite Smoke Ventilation System is designed to open a Keylite Roof Window automatically, in the event of a fire.

### Features

- ▶ The system is also provided with a 3-day battery back-up should the building's electrical system fail.
- ▶ This system integrates seamlessly with a building's fire alarm interface, or can operate independently as a stand alone system.
- ▶ Please visit the Keylite website to view wiring diagrams.
- ▶ Additional functionality inspection available. For commissioning please contact the Keylite Technical Department for further information.



### Smoke Vent Kit

SVK

### Kit includes:

Motor(s), Control Panel, Break Glass, Smoke Sensor & 3 day battery back-up pack.  
Roof Window & flashing not included.

To provide **1m<sup>2</sup>** Smoke Ventilation the SVK should be added to a Keylite CP08 (1140 x 1180mm) window type and flashing.

To provide **1.5m<sup>2</sup>** Smoke Ventilation the SVK should be added to a Keylite CP10 (1340 x 1400mm) window type and flashing.

When SVK + window are ordered together, the motor is factory fitted free of charge.



# Sun Lite™ Light Tube System (SL)

**A Keylite Sun Lite™ transports natural daylight into areas where conventional pitched or flat roof windows cannot be used.**

The highly reflective light tube enables daylight to travel from the roof to an interior space deprived of natural light.

## Features

- ▶ Available with a 'rigid' or 'flexible' light tube, to suit your roof design.
- ▶ Transforms dark or windowless rooms. Ideal for bathrooms, stairways and corridors.
- ▶ Saves energy by reducing the use of artificial light.
- ▶ Reduce the need for additional ceiling fittings by integrating the fluorescent lamp option to any Sun Lite™ rigid system.

### Each Keylite Sun Lite™ includes:

- ▶ Roof flashing and covering.
- ▶ Preferred tubing - rigid or flex (rigid recommended).
- ▶ White ceiling diffuser.

Keylite recommend a **minimum 350mm diameter** Rigid Light Tube System to achieve 98% reflectance.

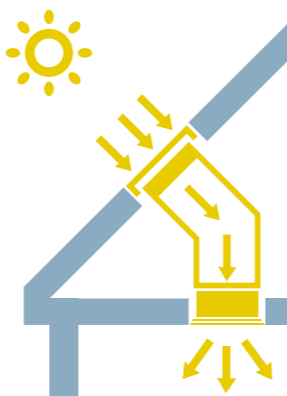

Sun Lite™ Window System		Size			
		250mmø	350mmø	450mmø	530mmø
Flush Fit Glass Sun Lite™	Rigid System	-	SLR350	SLR450	SLR530
	Flexi-System	-	SLF350	SLF450	SLF530
Polycarbonate Dome Sun Lite™	Rigid System	SLR250	-	-	-
	Flexi-System	-	-	-	-
Flat Roof Polycarbonate Sun Lite™	Rigid System	-	SLR350FRS	SLR450FRS	SLR530FRS
	Flexi-System	-	SLF350FRS	SLF450FRS	SLF530FRS

## Sun Lite™ Accessories

Sizes	Fluorescent Lamps	Rigid Extension (600mm)
250mmø	250SLF20	250SLER
350mmø	350SLF20	350SLER
450mmø	450SLF20	450SLER
530mmø	530SLF20	530SLER

	Recommended Usage			
	250 mm (Diameter)	350 mm (Diameter)	450 mm (Diameter)	530 mm (Diameter)
<b>Rigid tube</b>	En suite, WC, Walk-in-wardrobe	Bathroom, Hallway, Small Landing Suitable for rooms 4m x 4m	Bathroom, Landing, Offices, Corridors Suitable for rooms 5m x 5m	Commercial & Retail, Corridors, Offices Suitable for rooms 6m x 6m
<b>Flexi-tube</b> Max. recommended length 2m	-	En suite, WC, Walk-in-wardrobe	Bathroom, Hallway, Small Landings Suitable for rooms 4m x 4m	Living areas, Large Landings, Kitchen Suitable for rooms 5m x 5m

**Note:** When placing your order please specify Tile, Slate or Plain Tile Flashing. If roof void is more than 2m please call the Keylite Technical Team.

## Rigid Light Tube System

**For optimum performance**  
Keylite's rigid tube system is made using a hard wearing, mirror finished, polished aluminium tube with 98% reflectance.

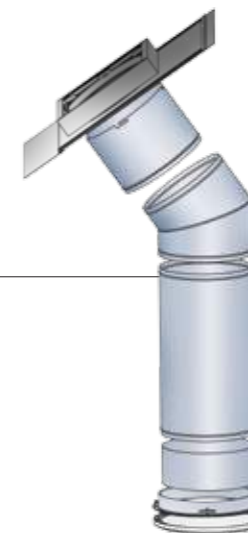

## Flexi Light Tube System

**For versatility**  
Recommended for installations where obstructions within the roof prohibit the use of a rigid system.



## Pitched Roof System



### Flush Fit Glass Sun Lite™



### Additional features

- ▶ Ventilated as standard. Unique ventilation features at both roof and ceiling level combating the risk of condensation.
- ▶ Self-cleaning feature on the external glazing pane.
- ▶ Ceiling diffuser with magnetic connectors for easy install and quick removal for cleaning

### Diameter

- ▶ 530mm
- ▶ 450mm
- ▶ 350mm

### Tube length

- ▶ 2m



### Polycarbonate Dome Sun Lite™



### Additional features

- ▶ Hemispheric polycarbonate dome for optimised capture of natural light.

### Diameter

- ▶ 250mm

### Tube length

- ▶ 1.7m



## Flat Roof System

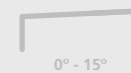

### Flat Roof Polycarbonate Dome Sun Lite™



### Additional features

- ▶ Ventilated as standard. Unique ventilation features at both roof and ceiling level combating the risk of condensation.
- ▶ Ceiling diffuser with magnetic connectors for easy install and quick removal for cleaning

### Diameter

- ▶ 530mm
- ▶ 450mm
- ▶ 350mm

### Tube length

- ▶ 2m



# Genuine Keylite Blinds

Create atmosphere with our specially designed blinds. Control, block and soften daylight for every mood and every space at home.

## Features

- ▶ Side rails for total 100% blackout.
- ▶ Roller cover prevents fading of coloured fabrics.
- ▶ Thermal benefits - reducing heat loss by at least 20% (BBA tested).
- ▶ 100% safety focused cordless operation.
- ▶ **Surrounds**  
Available with aluminium or white finish surround.
- ▶ **Upgrade to electric**  
Choose an electrical blind for automated opening and closing.



## Fabric choice



### Choose Blackout

**No 1 choice for bedrooms and cinema rooms**

We offer an extensive range of blackout blinds, all of which include thermal fabric as standard, for extra cosiness and warmth.



### Choose Dimout

**No 1 choice for living rooms and landings**

For those who want to transform their home into a place of restful relaxation, then the dimout blind is the perfect choice.



### Choose Wipe Clean, Moisture Resistant Blinds

**No 1 choice for bathrooms and kitchens**

Wipe clean blinds which are completely moisture resistant, with an easy wipe clean texture. No more stains, no more odours, just blinds that can stand the test of time in your home.

# Practical features

**Cord free**  
For 100% child safety and peace of mind in the home

## New design

**New**

Keylite blinds come with slim aluminium side rails for smooth operation and a clean classic look. This also gives increased natural light when the blinds are open

## Energy efficient

Controls solar heat gain. Thermal benefits reduce heat loss by at least 20%. (BBA Tested)

## Fingertip control

easy and smooth operation



## Fully enclosed cassette

to protect fabric from discolouration and eliminate light glow around the edge



## Fully encased side rails

with brush seals to provide 100% blackout and improve thermal efficiency

## Surround options

Available in brushed Aluminium or White finish



## Upgrade to electrical

Our solar powered and electric blinds are ideal for those out of reach locations from the comfort of your armchair or bed

# Selecting your Keylite Blinds



ORDER **ONLINE**  
[www.keyliteblinds.com](http://www.keyliteblinds.com)



ORDER **HOTLINE**  
UK: +44 (0)12 8320 0159 NI & ROI : +44 (0)28 8676 7515



Please follow these simple steps to select your blind.

## STEP 1

Identify your window's serial number.

- ▼ Locate the **serial number** on the silver identification card, under the ventilation handle.



## STEP 2

Choose type of blind required.

- ▼ **Blackout Blinds**  
Block all exterior light sources, perfect for a bedroom or home cinema.



- ▼ **Dimout Blinds**  
Provide privacy and control of sunlight.



## STEP 3

Choose type of surround required.

- ▼ **White Finish Surround**  
The perfect complement to your White Finish windows.



- ▼ **Aluminium Surround**  
Ideal with Pine Windows for a contemporary finish.



## STEP 4

Choose from the following colours

Classic White Blackout: 0008 Dimout: 0008T	Antique Cream Blackout: 0649 Dimout: 0649T	Caramel Latte Blackout: 0653 Dimout: 0653T	Intense Hazelnut Blackout: 0655 Dimout: 0655T	Fossil Grey Blackout: 0519 Dimout: 0519T
Twilight Blackout: 0224 Dimout: 0224T	Grey Whisper Blackout: 0511 Dimout: 0511T	Mango Fusion Blackout: 0424 Dimout: 0424T	Firecracker Red Blackout: 0117 Dimout: 0117T	Fresh Mint Blackout: 0321 Dimout: 0321T
Sky Breeze Blackout: 0214 Dimout: 0214T	Cotton Candy Blackout: 0113	Lemon Zest Blackout: 0421 Dimout: 0421T	Black Velvet Blackout: 0009 Dimout: 0009T	Raspberry Rush Blackout: 0112
Pink Blush Blackout: 119 Dimout: 106T	Aqua Falls Blackout: 223	Marble White Blackout: 0068	Marble Cream Blackout: 0069	Marble Black Blackout: 0070

● = Fire retardant and wipe clean fabric blinds.

# Single Window Flashings

Keylite Flashing Kits are the most efficient way to ensure a watertight installation for your windows and have been designed to integrate efficiently with specific roofing materials.

The installer friendly instructions and one-piece bottom apron ensure easy first time fitting.

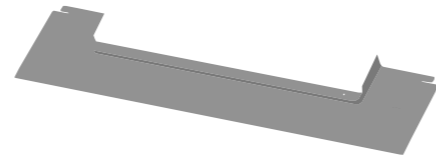

**One-piece bottom apron**  
The unique one-piece bottom apron design improves aesthetic finish and allows for easy installation.

# Combination Flashings

The Keylite range of Combination Flashing Systems allows any of the standard Keylite Roof Windows to be installed in vertical, horizontal or group blocks.

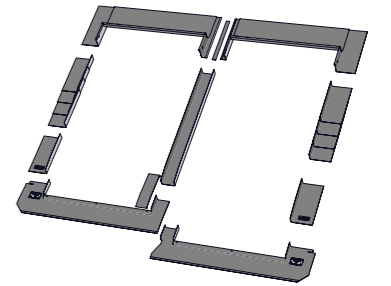

## Tile: TRF

- ▶ **Roof Pitch 20° – 90°**
- ▶ **Material Profile - Max 45 mm**  
Flashing for single window installation into interlocking profiled tiles or interlocking plain tiles.

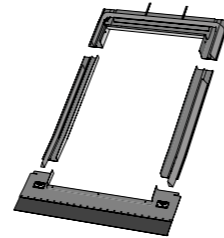
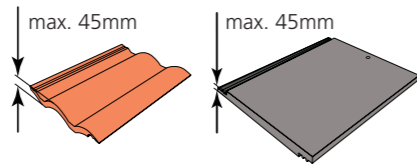

## Deep Tile: DTRF

- ▶ **Roof Pitch 15° – 90°**
- ▶ **Material Profile – Max 90mm**  
Flashing for single window installation into flat or profiled interlocking tiles. Also suitable for interlocking slate and profiled sheeting.

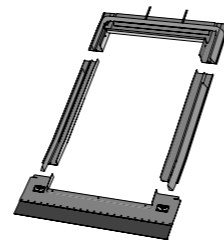
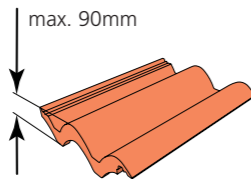

## Slate: SRF

- ▶ **Roof Pitch 15° – 90°**
- ▶ **Material Profile – Max 10mm**  
Flashing for single window installation into slate up to 10mm thick.  
*Not to be used with interlocking slate.*

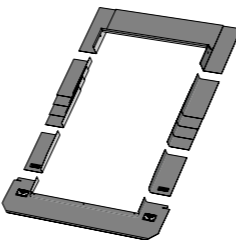
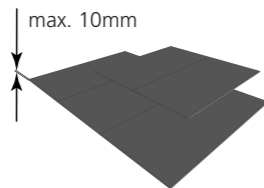

## Plain Tile: PTRF

- ▶ **Roof Pitch 25° – 90°**
- ▶ **Material Profile – Max 15mm**  
Flashing for single window installation into plain tiles.  
*Not to be used with interlocking plain tiles.*

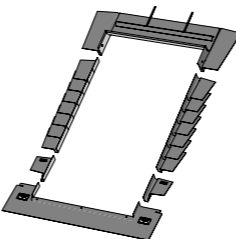
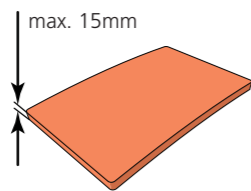

## Features

- ▶ Standard distance between window frames = **100mm**
- ▶ Variations and specials on request, please contact Keylite Sales Team for more information.

Side by Side - Combi

Over & Under - Bi-Lite

2 x 2 Square - Quad-Lite

Window Sizes (WxH)	550x780	550x980	550x1180	660x1180	780x980	780x1180	780x1400	940x1400	940x1600	1140x1180	1340x980	1340x1400
<b>Slate (8mm profile)</b> Product Code	SRF01	SRF02	SRF01C	SRF03	SRF04	SRF05	SRF06	SRF07F	SRF07	SRF08	SRF09	SRF10
<b>Tile (45mm profile)</b> Product Code	TRF01	TRF02	TRF01C	TRF03	TRF04	TRF05	TRF06	TRF07F	TRF07	TRF08	TRF09	TRF10
<b>Deep Tile (90mm profile)</b> Product Code	DTRF01	DTRF02	DTRF01C	DTRF03	DTRF04	DTRF05	DTRF06	DTRF07F	DTRF07	DTRF08	DTRF09	DTRF10
<b>Plain Tile (15mm profile)</b> Product Code	PTRF01	PTRF02	PTRF01C	PTRF03	PTRF04	PTRF05	PTRF06	PTRF07F	PTRF07	PTRF08	PTRF09	PTRF10
<b>Conservation Slate</b> Product Code	CWSRF01	CWSRF02	CWSRF01C	CWSRF03	CWSRF04	CWSRF05	CWSRF06	CWSRF07F	CWSRF07	CWSRF08	CWSRF09	CWSRF10
<b>Conservation Tile</b> Product Code	CWTRF01	CWTRF02	CWTRF01C	CWTRF03	CWTRF04	CWTRF05	CWTRF06	CWTRF07F	CWTRF07	CWTRF08	CWTRF09	CWTRF10
<b>Conservation Plain Tile</b> Product Code	CWPTRF01	CWPTRF02	CWPTRF01C	CWPTRF03	CWPTRF04	CWPTRF05	CWPTRF06	CWPTRF07F	CWPTRF07	CWPTRF08	CWPTRF09	CWPTRF10
<b>Combi Slate</b> Product Code	CSRF01	CSRF02	CSRF01C	CSRF03	CSRF04	CSRF05	CSRF06	CSRF07F	CSRF07	CSRF08	CSRF09	CSRF10
<b>Combi Tile (15-90mm profile)</b> Product Code	CTRF01	CTRF02	CTRF01C	CTRF03	CTRF04	CTRF05	CTRF06	CTRF07F	CTRF07	CTRF08	CTRF09	CTRF10
<b>Bi-lite Slate</b> Product Code	BLSRF01	BLSRF02	BLSRF01C	BLSRF03	BLSRF04	BLSRF05	BLSRF06	BLSRF07F	BLSRF07	BLSRF08	BLSRF09	BLSRF10
<b>Bi-lite Tile (15-90mm profile)</b> Product Code	BLTRF01	BLTRF02	BLTRF01C	BLTRF03	BLTRF04	BLTRF05	BLTRF06	BLTRF07F	BLTRF07	BLTRF08	BLTRF09	BLTRF10
<b>Quad-lite Slate</b> Product Code	QLSRF01	QLSRF02	QLSRF01C	QLSRF03	QLSRF04	QLSRF05	QLSRF06	QLSRF07F	QLSRF07	QLSRF08	QLSRF09	QLSRF10
<b>Quad-lite Tile (15-90mm profile)</b> Product Code	QLTRF01	QLTRF02	QLTRF01C	QLTRF03	QLTRF04	QLTRF05	QLTRF06	QLTRF07F	QLTRF07	QLTRF08	QLTRF09	QLTRF10

# Enhanced Installation Components

## Felt Collar

The Keylite Felt Collar (FC) is manufactured from a flexible material that creates an impenetrable seal around your roof window and unites with the underfelt of your roof to ensure a watertight seal.

## Vapour Collar

The Keylite Vapour Collar (VC) enhances the air tightness around your Keylite roof window, as well as preventing vapour passing through your roof construction.

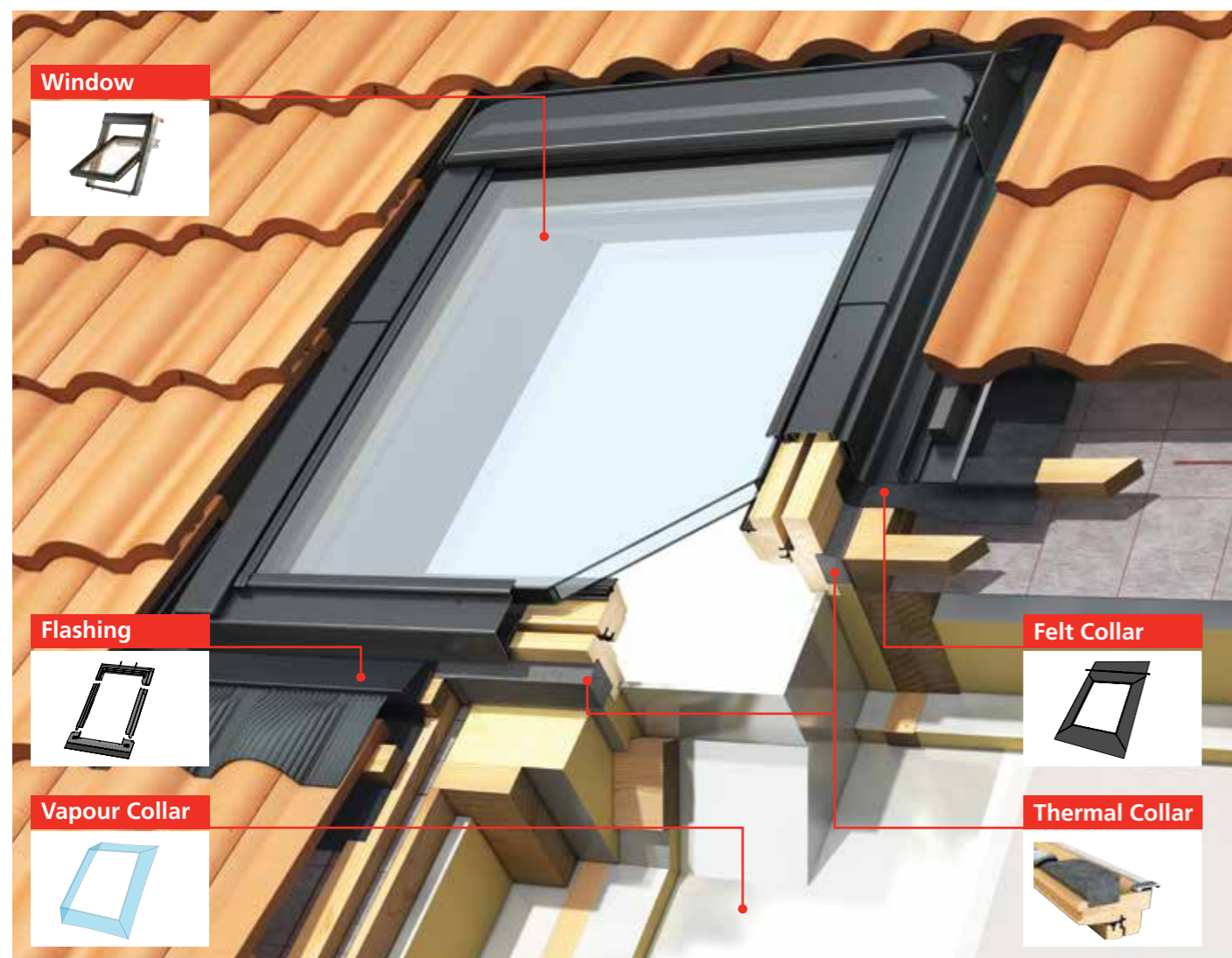

Window Sizes (WxH)	550x780	550x980	550x1180	660x1180	780x980	780x1180	780x1400	940x1400	940x1600	1140x1180	1340x980	1340x1400
<b>Felt Collar</b> Product Code	FC-01	FC-02	FC-01C	FC-03	FC-04	FC-05	FC-06	FC-07F	FC-07	FC-08	FC-09	FC-10
<b>Vapour Collar</b> Product Code	VC-01	VC-02	VC-01C	VC-03	VC-04	VC-05	VC-06	VC-07F	VC-07	VC-08	VC-09	VC-10
<b>Installation Package</b> Product Code Includes Felt Collar and Vapour Collar	IN-PK-01	IN-PK-02	IN-PK-01C	IN-PK-03	IN-PK-04	IN-PK-05	IN-PK-06	IN-PK-07F	IN-PK-07	IN-PK-08	IN-PK-09	IN-PK-10

# Accessories



Keylite also offers a range of quality Roof Window accessories



## Opening Pole (Blinds Control)

Manually control your window and blind with a telescopic opening pole. The telescopic pole is available in 2m and 3m lengths.



## Restrictor

For added safety, a Keylite opening restrictor is available.



## Security Lock

A Keylite security lock can be fitted for added security.



## Integral Blind Opening Pole

Manually control your integral blind with a 1m long opening pole.

# Loft Ladder

The Keylite Loft Ladder is designed to ensure simple, fast installation.

With pre-installed Flick-Fit brackets, allowing installation from below the loft, and with a unique detachable ladder which enables one-person installation, the Keylite Loft Ladder is designed to make your life easier.

## Features

- ▶ **Flick-Fit** installation - Pre-installed brackets for installation from below
- ▶ Continuous seal around trapdoor **reduces heat loss**
- ▶ **Pre-fitted handrail** as standard
- ▶ White 36mm thick **insulated trapdoor**, with U-Value of 1.1w/m<sup>2</sup>k as standard\*
- ▶ Unique **detachable ladder** - enables one person to install
- ▶ Recessed locking system
- ▶ **Slip resistant** treads
- ▶ **Dovetail** joints on all treads
- ▶ **Scratch resistant** protective feet

**NEW**



The new Keylite Fire Resistant Loft Ladder.

- ▶ A Loft ladder with a 30 minute fire rating, ideal for meeting specific building regulations.

For further details contact the Keylite Technical Team.

EN 13501-2 EN 1634-1



### 3 SEGMENT LADDERS

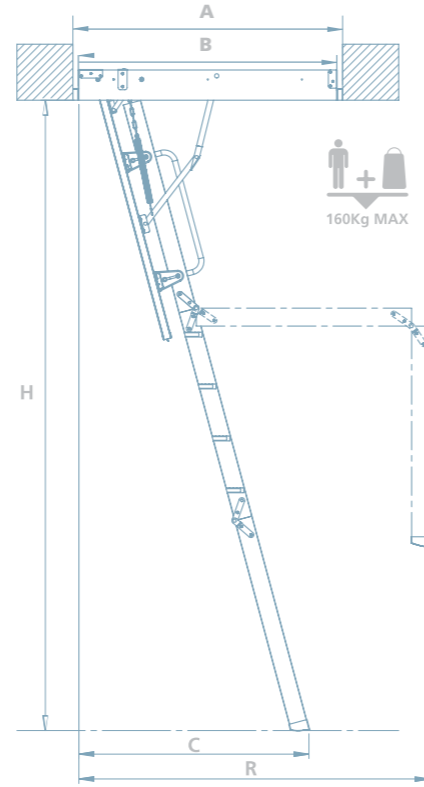

### 4 SEGMENT LADDERS

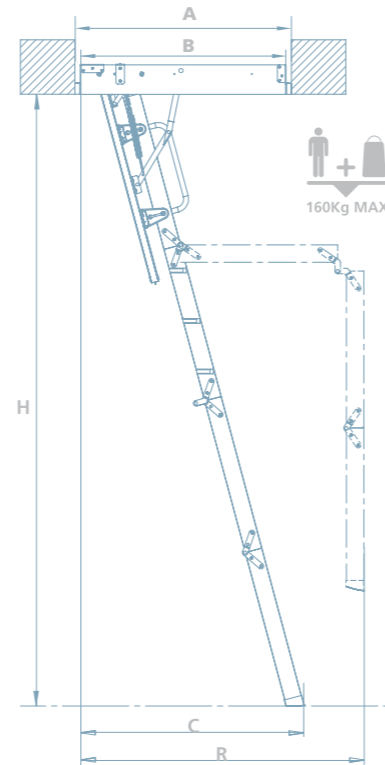

**FAST-EASY**  
ONE PERSON INSTALLATION

Continuous seal around trapdoor reduces heat loss

**Unique Innovation New**  
**Flick-Fit Installation**  
Pre-installed brackets for installation from below

**Pre-fitted handrail** as standard

White 36mm thick insulated trapdoor, with U-Value of 1.1w/m<sup>2</sup>k as standard\*

Unique **detachable ladder** enables one person to install

**Recessed locking system**

Slip resistant treads

**Scratch resistant protective feet**

**Dovetail joints** on all treads

\*U-Value determined by calculation

Keylite Product Code	KYL01	KYL02	KYL03	KYL04	KYL05	KYL06	KYL07	KYL08	KYL09
<b>A</b> Ceiling opening dimension (mm)	550 x 1000	550 x 1200	550 x 1200	600 x 1000	600 x 1200	600 x 1200	700 x 1000	700 x 1200	700 x 1200
<b>B</b> Frame external dimension (mm)	530 x 940	530 x 1140	530 x 1140	580 x 940	580 x 1140	580 x 1140	680 x 940	680 x 1140	680 x 1140
<b>C</b> Number of ladder sections	4	3	4	4	3	4	4	3	4
(mm)	1025	1025	1145	1025	1025	1145	1025	1025	1145
<b>R</b> (mm)	1300	1565	1605	1300	1565	1605	1300	1565	1605
<b>H</b> (mm)	2800	2800	3200	2800	2800	3200	2800	2800	3200



# Roof Window Support Trims

Keylite Roof Window Support Trims are designed to offer increased structural support, and provide an enhanced aesthetic appearance to roof windows that are installed side by side.

Available in a choice of Pine or White, our support trims provide the perfect interior finish.

Keylite Product Code	Description
ST-100-2000	Pine Support Trimmer 100mm Spacing 2000mm long
ST-100-2700	Pine Support Trimmer 100mm Spacing 2700mm long
ST-100-3500	Pine Support Trimmer 100mm Spacing 3500mm long
ST-50-2000	Pine Support Trimmer 50mm Spacing 2000mm long
ST-50-2700	Pine Support Trimmer 50mm Spacing 2700mm long
ST-50-3500	Pine Support Trimmer 50mm Spacing 3500mm long
ST-18-2000	Pine Support Trimmer 18mm Spacing 2000mm long
ST-18-2700	Pine Support Trimmer 18mm Spacing 2700mm long
ST-18-3500	Pine Support Trimmer 18mm Spacing 3500mm long
WF-ST-100-2000	White Support Trimmer 100mm Spacing 2000mm long
WF-ST-100-2700	White Support Trimmer 100mm Spacing 2700mm long
WF-ST-100-3500	White Support Trimmer 100mm Spacing 3500mm long
WF-ST-50-2000	White Support Trimmer 50mm Spacing 2000mm long
WF-ST-50-2700	White Support Trimmer 50mm Spacing 2700mm long
WF-ST-50-3500	White Support Trimmer 50mm Spacing 3500mm long
WF-ST-18-2000	White Support Trimmer 18mm Spacing 2000mm long
WF-ST-18-2700	White Support Trimmer 18mm Spacing 2700mm long
WF-ST-18-3500	White Support Trimmer 18mm Spacing 3500mm long

Roof Window Support Trim



“Keylite support trims provide the perfect finish.”

# Service & Support

Keylite Roof Windows come with a 10-year 'hassle-free' product guarantee.

Please register your roof windows using the Guarantee Card supplied with your window, or online at [www.keyliteguarantee.com](http://www.keyliteguarantee.com)

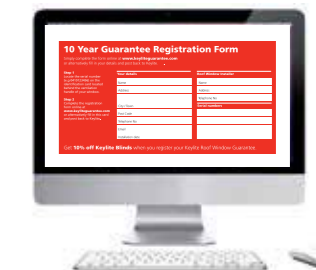

Visit us at:

**keyliterateofwindows.com**

- ▶ Download **FastrackCAD** files
- ▶ Extensive product range
- ▶ Product support
- ▶ Architect lounge
- ▶ Installation videos



# Installation Instructions

Full instructions and installation videos are available to download on [www.keyliteroofwindows.com](http://www.keyliteroofwindows.com)

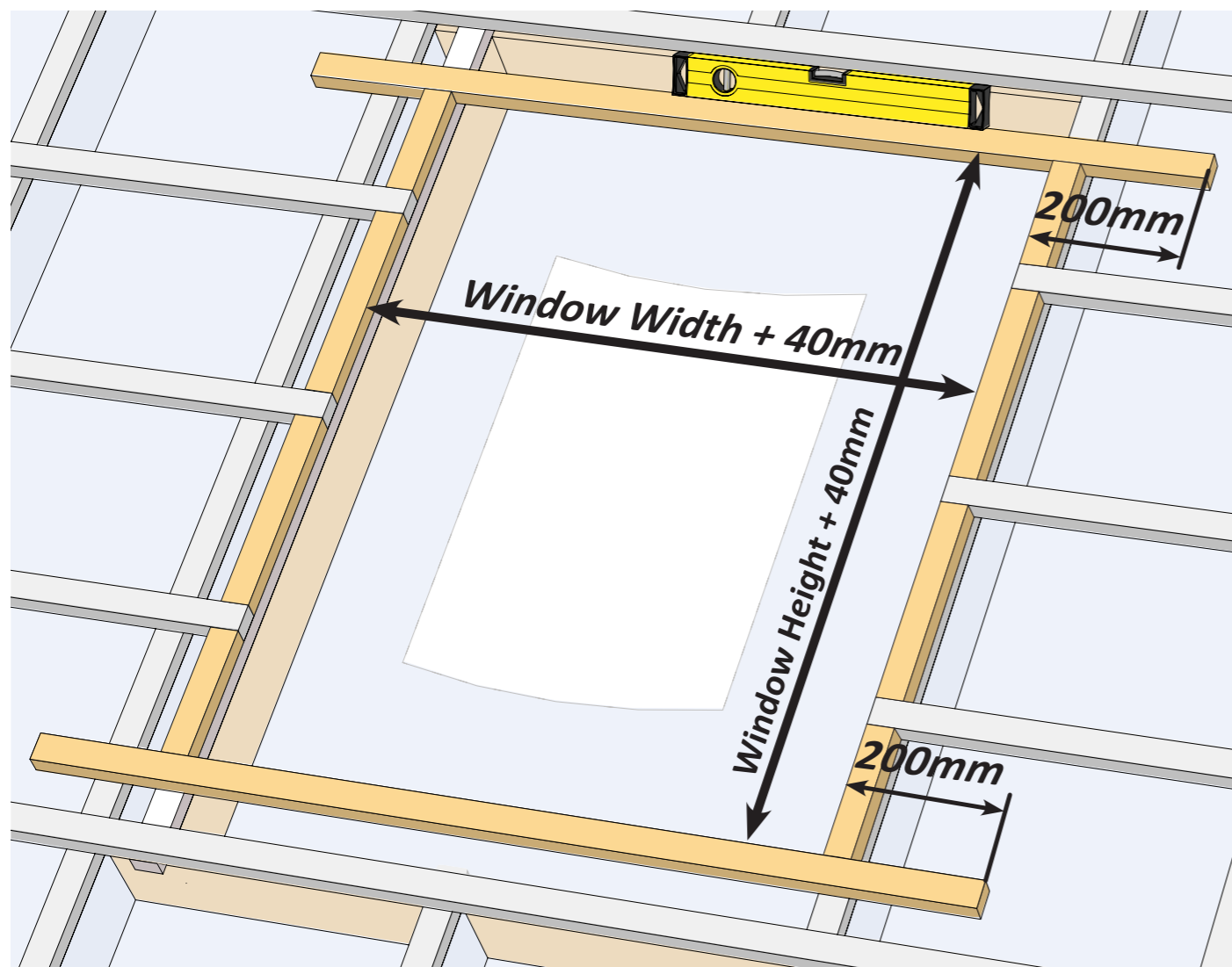

**IMPORTANT**  
40mm allowance must be given for the roof window opening (leaving a 20mm gap between window frame and batten). This ensures room for alignment and maximises the performance of Keylite's Futuretherm Technology™

**Example: CP-04-T**  
The outermost dimension of every Keylite Roof Window is printed on our packaging labels. For a CP-04-T window, the width of the opening in the roof must be:  
780mm (+40mm) X 980mm (+40mm)  
**= 820mm X 1020mm**

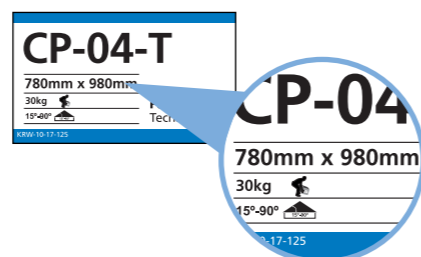

Scan this QR code for direct access to our fitting instructions.

# Window Sizes & Product Codes

The Keylite Roof Window range is available in both standard and non-standard sizes.

The matrix below can be used to establish the size and type of roof window available within the Keylite range.

		Window Width (mm)							
		550	660	780	940	1140	1340		
Window Height (mm)	780	<b>01</b> CP ICP FRS CW CP ICW CP WF	<b>03A</b> CP CW FRS WF	<b>04A</b> CP CW FRS WF	<b>07A</b> CP CW FRS WF	<b>08A</b> CP CW FRS WF	<b>09A</b> CP CW FRS WF		
	980	<b>02</b> CP TH CWCP ITH ICWTH ICWCP ICP	<b>03B</b> CP TH CW FRS WF	<b>04</b> CP FE IFE CW ICP FRS ICW WF	<b>07B</b> CP FE CW FRS WF	<b>08B</b> CP FE CWFE CW FRS WF	<b>09</b> CP FE IFE CWFE ICP FRS		
	1180	<b>01C</b> CP FE CWCP CWFE FRS WF	<b>03</b> CP FE CWFE IFE ICW ICWFE	<b>05</b> CP FE FRS IFE CWCP ICWCP CWFE	<b>07C</b> CP FE CW FRS WF	<b>08</b> CP FE FRS IFE CWCP ICWCP CWFE	<b>09C</b> CP FE CWCP FRS WF		
	1400	<b>01F</b> CP FE CWCP FRS WF	<b>03F</b> CP FE CW FRS WF	<b>06</b> CP CWCP FRS IFE ICWCP CWFE	<b>07F</b> CP FE CW FRS WF	<b>08F</b> CP FE CW FRS WF	<b>10</b> CP FE CW FRS WF		
	1600	<b>01G</b> CP FE CW FRS WF	<b>03G</b> CP FE CW FRS WF	<b>04G</b> CP FE CW FRS WF	<b>07</b> CP FE FRS IFE ICWCP CWFE	<b>08G</b> CP FE CW FRS WF	<b>09G</b> CP FRS WF		

Standard Size Roof Window range (Blue background) Non-Standard Size Roof Window range (White background)

CP Centre Pivot  
ICP Integral Blind Centre Pivot  
TH Top Hung  
ITH Integral Blind Top Hung  
FE Fire Escape  
IFE Integral Blind Fire Escape

CW CP Conservation Window Centre Pivot  
CW TH Conservation Window Top Hung  
CW FE Conservation Window Fire Escape  
ICW CP Integral Blind Conservation Window Centre Pivot  
ICW TH Integral Blind Conservation Window Top Hung  
FRS Flat Roof System  
WF White Finish

**NOTE:**  
White Finish and Glazing Option are available for the entire Roof Window range. Glazing Option is not available with Integral Blind.



[keyliteratech.com](http://keyliteratech.com)

#### **UK**

Ryder Close, Cadley Hill Industrial Estate,  
Swadlincote, South Derbyshire, DE11 9EU

T: +44 (0) 1283 200 150  
E: [info@keyliteuk.com](mailto:info@keyliteuk.com)

#### **NI & ROI**

Derryloran Industrial Est. Sandholes Road,  
Cookstown, Co. Tyrone, BT80 9LU

T: +44 (0) 28 8675 8921  
E: [info@keylite.co.uk](mailto:info@keylite.co.uk)